

SC6 CHANNEL FIXTURE INSTALLATION GUIDE



TECHNICAL SUPPORT
(+1) 212 629 6830 *301
Tech@GENLEDBrands.com



U.S. PRICING & SALES SUPPORT
(+1) 212 629 6830 *300
Sales-US@GENLEDBrands.com



U.S. CUSTOMER SERVICE
(+1) 212 629 6830 *304
CustomerService@GENLEDBrands.com

Our US team is in place to answer all of your product questions and help with installations.

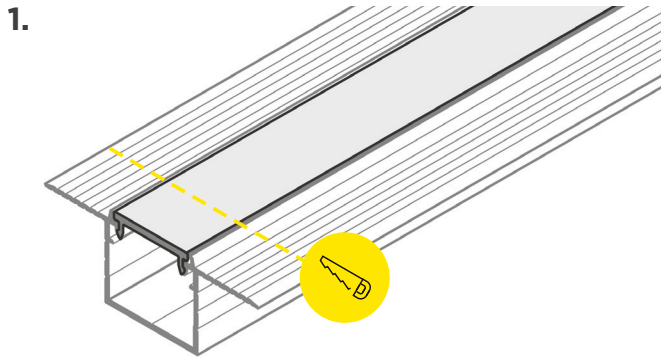

1. Cut channel and lens to desired length.

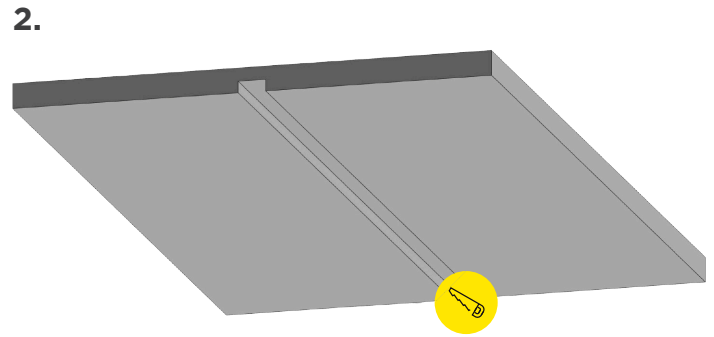

2. Measure the size of the channel and mounting clips and cut a recess into the surface to match the size of the channel and mounting clips.

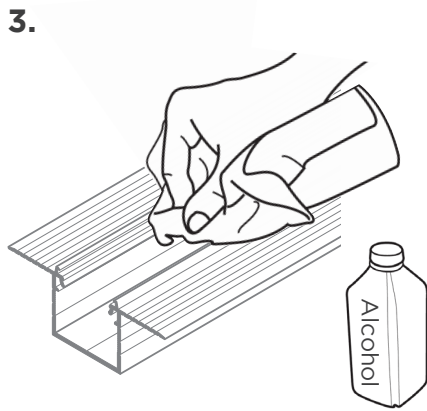

3. Clean the inside surface of the channel of dust and debris with rubbing alcohol. Dry.

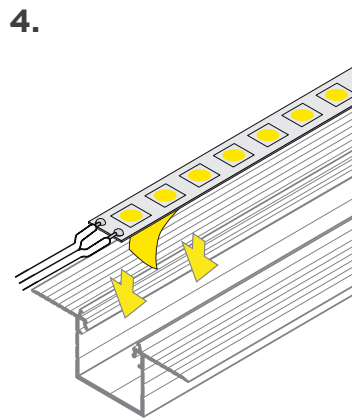

4. Apply RibbonLyte. Make all necessary electrical connections. (Feed through end caps as needed.)

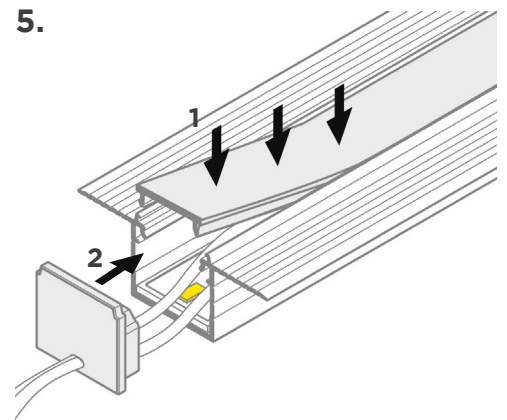

5. Attach lens by sliding or snapping into place. Attach end caps.

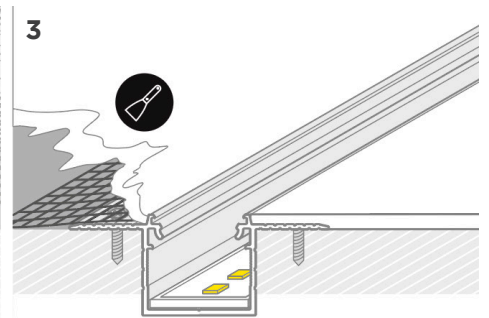
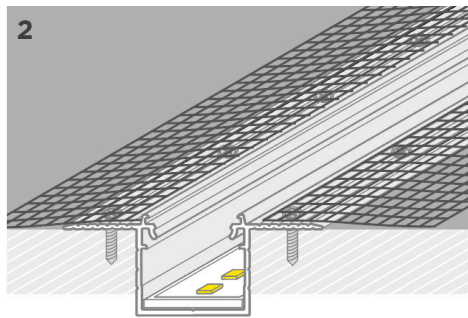
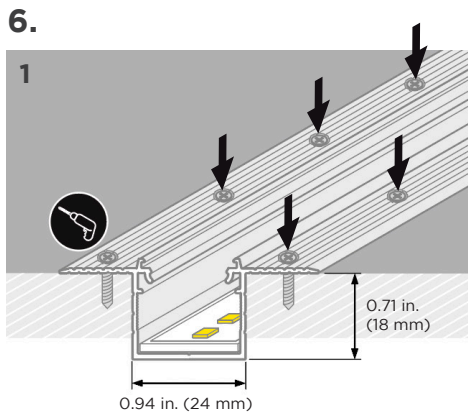

6. Place fixture in recess and attach by screwing flanges to surface. Mud-in to achieve flush finish. Fixture installation complete.