

COMPONENTS:

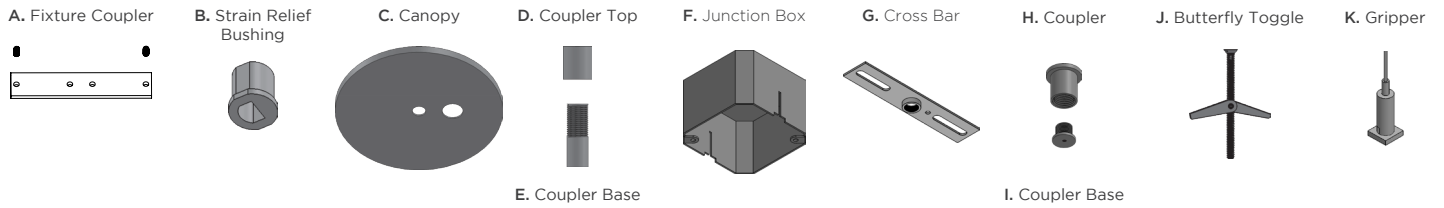

SUGGESTED WIRE SEPARATION:

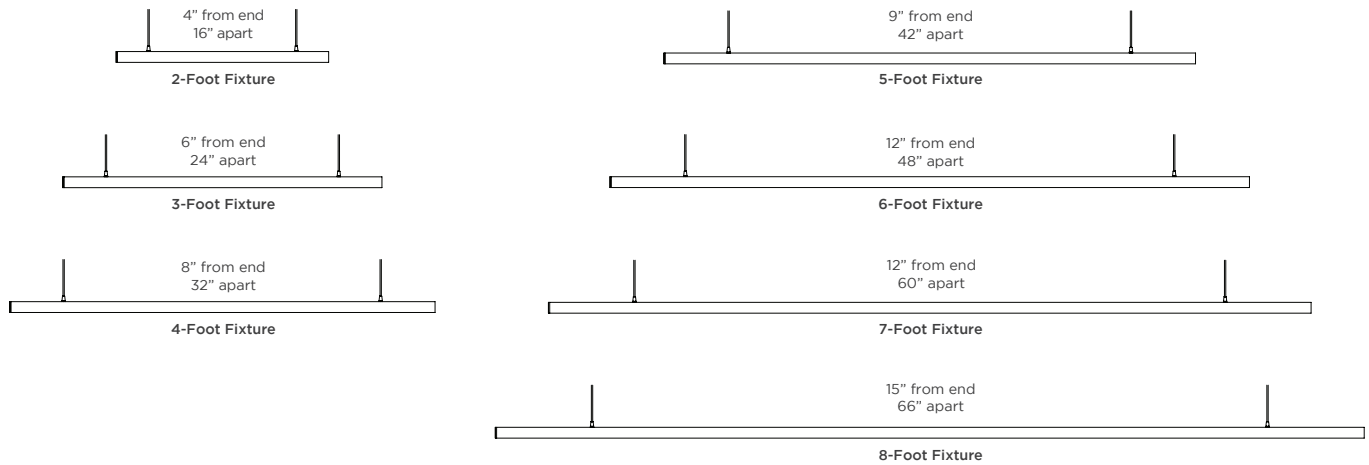

POWER CONNECTIONS:

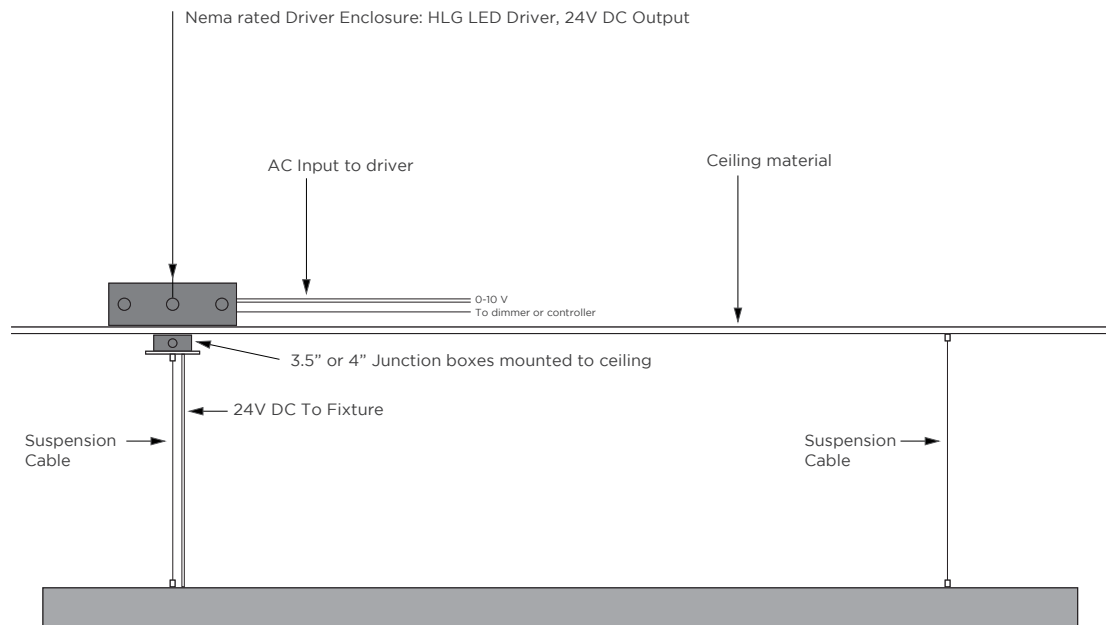
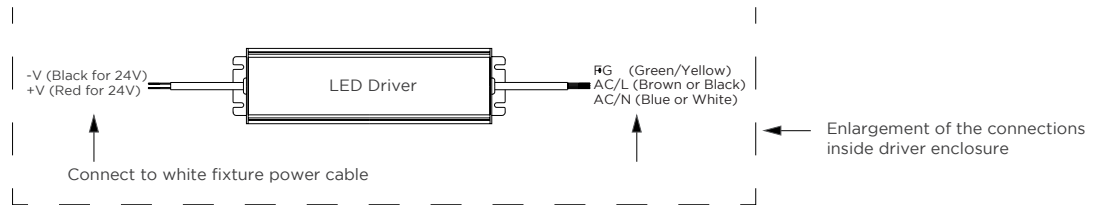

POWER FEED INSTALLATION:

1. Insert the wire through the Strain Relief Bushing (B), and then fit the wire with Strain Relief Bushing (B) into the Canopy (C).

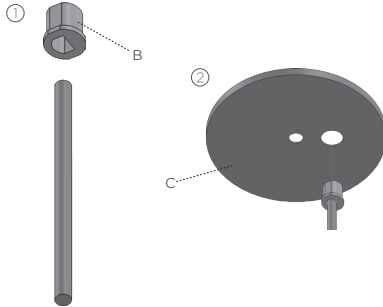

2. Attach the Cross Bar (G) to the Junction Box (F) with screws, and insert the screw into the hole in the center of the Cross Bar (G).

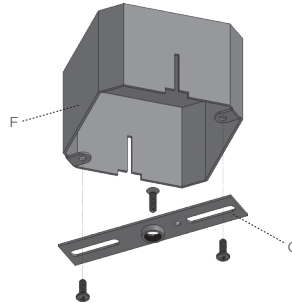

3. Put the aircraft cable through the Coupler Top (D) and Coupler Base (E) and pull the wire down, and then tighten the Coupler Base (E) onto the Coupler Top (D) as shown on ⓐ. Put the Coupler Top and Base (D, E) with wire through the center hole on the Canopy (C) as shown on ⓑ.

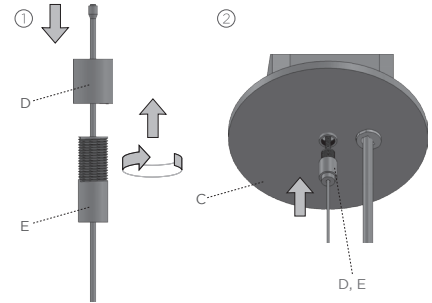

4. Put the screw in the center of the Cross Bar (G) on the Junction Box (F) through the Coupler Top and Base (D, E) and then tighten it.

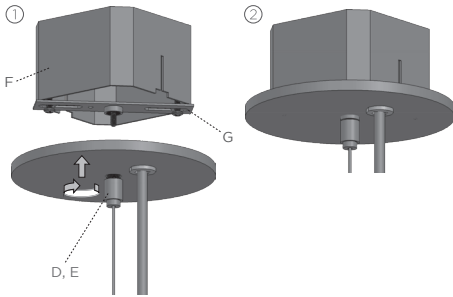

5. As an added precaution, make sure the coupler is tightened to the fixture securely. Adjust the cable length to desired height on top of the fixture, and cut excess cable off.

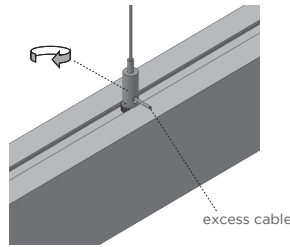

6. Repeat Steps 1-5 for the other side to complete installation.

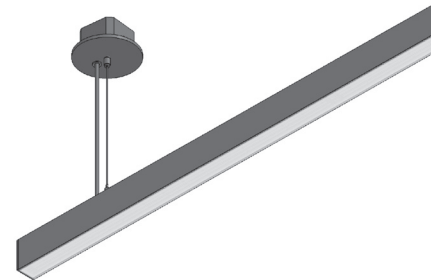

DIRECT-ONLY INSTALLATION WITH HARD CEILING:

1. Repeat Steps 1-5 of the power feed installation.

2. For non-power feed side of the fixture, follow these steps. Mark the desired hanging point on the ceiling and drill a 1-1/2" deep hole into the concrete with a 3-1/2" long, 5/32" drill bit.



3. Insert anchor into drill hole.

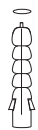

Not supplied by Acolyte

4. Use screw to attach Coupler (H) so that it is flush with the ceiling.

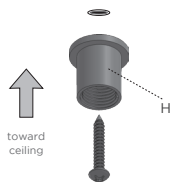

5. Slide aircraft cable through opening of Coupler Base (I) so the end of the cable with the metal stopper is pulled snug against the small opening on the inside of the Coupler Base (I). Screw Coupler Base into Coupler (H).

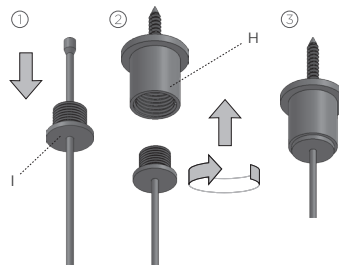

6. As an added precaution, make sure the coupler is tightened to the fixture securely.

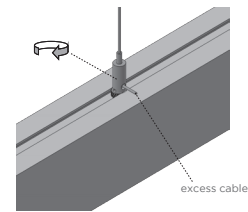

DIRECT-ONLY INSTALLATION WITH DRYWALL/GYPSUM CEILING:

1. Repeat Steps 1-5 of the power feed installation.

2. Slide Aircraft Cable through opening of Coupler Base (I) so the end of the Cable with the Metal Stopper is pulled snugly against the small opening on the inside of the Coupler Base (I). Put the Butterfly Toggle (J) through the Coupler (H). Fold the Butterfly Toggle (J) to fit through drilled hole in drywall.

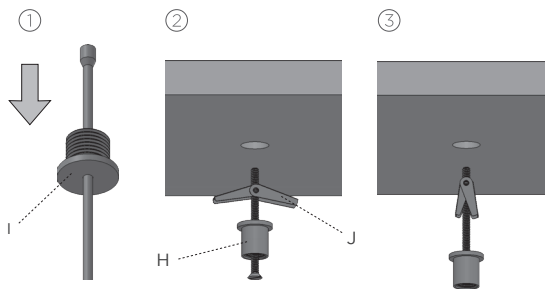

3. Make sure the Coupler (H) is securely screwed on the drywall, and then screw in Coupler Base (I) into Coupler (H).

