

### ARMOR SERIES | RGBW AC MINI EXTERIOR LINEAR FIXTURES

RGBW AC Mini Linear fixtures feature an onboard driver. Available in RGBW with three distinct static white CCTs ranging from 3000K to 6500K, the RGBW AC Mini offers 4 optic beam angles and comes in 4 different lengths. You can daisy chain these fixtures for up to 68 feet at 120 VAC. Connect up to 32 fixtures per DMX controller. This addition to the Armor Series exterior product line is a fantastic solution for wall washing and grazing to create dramatic façade lighting. No remote drivers necessary!

#### GEL-FLUSH™ TECHNOLOGY

The RGBW AC Mini Linear fixture is manufactured with our Gel-Flush™ Technology. Developed with a special sealant from Dow Corning, this proprietary innovation prevents any breach from weather-related elements. No leaking. No condensation. Just clear, unobstructed beams of light.



#### Applications:

Commercial      Museums  
Entertainment   Public Spaces

### ORDERING GUIDE

Category	Input Voltage	Length	Color	FWHM Beam Angle
<b>MINI</b>	<b>AC</b>			
<b>MINI - Armor RGBW Mini</b>	<b>AC - AC 90-264 V</b>	<b>16</b> - 16.1 in. (410 mm) 20 W	<b>RGBW30</b> - RGB+3000K	<b>15</b> - 15x15°
		<b>24</b> - 23.8 in. (605 mm) 30 W	<b>RGBW40</b> - RGB+4000K	<b>25</b> - 25x25°
		<b>36</b> - 35.4 in. (900 mm) 45 W	<b>RGBW65</b> - RGB+6500K	<b>35</b> - 35x35°
		<b>47</b> - 46.9 in. (1190 mm) 60 W		<b>50</b> - 50x50°

#### OPTIONAL ACCESSORIES:

##### 1.) Armor Series Mounting Arms:

Small: ARMORMNT0609  
Large: ARMORMNT1422

##### 3.) Asymmetric Louver:

MINIALOUVRGBW410 (410 mm)  
MINIALOUVRGBW605 (605 mm)  
MINIALOUVRGBW900 (900 mm)  
MINIALOUVRGBW1190 (1190 mm)

##### 5.) 6 Pin Male to Female Jumper Cable:

MINIJUMP6PINMK1000 (1000 mm)  
MINIJUMP6PINMK2000 (2000 mm)

##### 7.) End Cap:

MINIAC-CAPRGBW

##### 2.) Symmetric Louver:

MINILOUVRGBW410 (410 mm)  
MINILOUVRGBW605 (605 mm)  
MINILOUVRGBW900 (900 mm)  
MINILOUVRGBW1190 (1190 mm)

##### 4.) Glare Shield:

MINISHLD410 (410 mm)  
MINISHLD605 (605 mm)  
MINISHLD900 (900 mm)  
MINISHLD1190 (1190 mm)

##### 6.) 6 Pin Cable with Female Connector to Bare Wire (Power):

MINICBLFB6PIN2000 (2000 mm)  
MINICBLFB6PIN6000 (6000 mm)

### AVAILABLE COLORS



RGBW

### AVAILABLE BEAM ANGLES

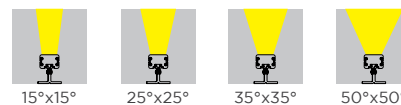

SPECIFICATIONS / DIMENSIONS / LUMEN DATA

Operating Voltage	90-264 VAC			
Length	16.1 in. / 410 mm	23.8 in. / 605 mm	35.4 in. / 900 mm	46.9 in. / 1190 mm
Power Consumption	20 W	30 W	45 W	60 W
Amperage	0.17 A @ 120V 0.09 A @ 230V 0.08 A @ 277V	0.26 A @ 120V 0.14 A @ 230V 0.12 A @ 277V	0.39 A @ 120V 0.21 A @ 230V 0.16 A @ 277V	0.52 A @ 120V 0.27 A @ 230V 0.23 A @ 277V
LEDs per Fixture	10 LEDs	15 LEDs	24 LEDs	30 LEDs
Color / Temperature	RGBW (3000K, 4000K, 6500K)			
LED Beam Angle	15x15°, 25x25°, 35x35°, 50x50°			
Max Daisy Chained Power	32 fixtures @ 120 VAC 32 fixtures @ 220-240 VAC	30 fixtures @ 120 VAC 32 fixtures @ 220-240 VAC	22 fixtures @ 120 VAC 30 fixtures @ 220-240 VAC	17 fixtures @ 120 VAC 24 fixtures @ 220-240 VAC
Control System	DMX			
LED Binning (SDCM)	3-Step MacAdam ellipse (White Channel Only)			
Ambient Temperature	-40 — 122 °F (-40 — 50 °C)			
Housing / Lens Materials	Housing: Extruded Aluminium / Lens: Clear UV Protected PMMA Cover: Tempered Glass End Caps: Extruded Aluminium / Brackets: Extruded Aluminium Housing, bracket, end cap material - 6063 high density aluminum alloy			
Connector	6 Pin Combined Power and DMX. 16 AWG Power / 22 AWG DMX			
Cable Length	11.81 in. / 300 mm			
Protection Rating	IP67			
Mounting Options	Large Tilttable Stand (180° adjustable), Mounting Arms (available in 2 different sizes)			
Impact Rating	IK08			
Lifetime (L70 reported)	50,000 hours			
Certifications	Luminaires - UL 1598, 3rd Ed., issued September 17, 2008, Rev. October 17, 2012 / Luminaires - CSA C22.2 No.250.0-08, 3rd Ed., issued September 17, 2008, Rev. October 17, 2012 (R2013)			
Fixture Color Finish	Anodized Silver			

LIGHT OUTPUT FOR 16.1 IN. / 410 MM

Beam Angles	15x15°					25x25°					35x35°					50x50°				
	Red	Green	Blue	White	All	Red	Green	Blue	White	All	Red	Green	Blue	White	All	Red	Green	Blue	White	All
Lumen / Foot	132	222	61	203	667	126	218	60	201	651	127	218	49	193	541	108	210	46	191	524
Lumen / Meter	435	729	200	666	2188	415	714	197	658	2137	418	714	160	635	1775	354	688	152	628	1721
Total Lumens	175	294	81	269	883	167	288	79	265	862	169	288	65	256	716	143	277	61	253	694

LIGHT OUTPUT FOR 23.8 IN. / 605 MM

Beam Angles	15x15°					25x25°					35x35°					50x50°				
	Red	Green	Blue	White	All	Red	Green	Blue	White	All	Red	Green	Blue	White	All	Red	Green	Blue	White	All
Lumen / Foot	132	222	61	203	667	126	218	60	201	651	127	218	49	193	541	108	210	46	191	524
Lumen / Meter	435	729	200	666	2188	415	714	197	658	2137	418	714	160	635	1775	354	688	152	628	1721
Total Lumens	263	441	121	403	1324	251	432	119	398	1293	253	432	97	384	1074	214	416	92	380	1041

LIGHT OUTPUT FOR 35.4 IN. / 900 MM

Beam Angles	15x15°					25x25°					35x35°					50x50°				
	Red	Green	Blue	White	All	Red	Green	Blue	White	All	Red	Green	Blue	White	All	Red	Green	Blue	White	All
Lumen / Foot	132	222	61	203	667	126	218	60	201	651	127	218	49	193	541	108	210	46	191	524
Lumen / Meter	435	729	200	666	2188	415	714	197	658	2137	418	714	160	635	1775	354	688	152	628	1721
Total Lumens	421	706	194	645	2118	402	691	190	637	2069	405	691	155	614	1718	342	666	147	608	1666

LIGHT OUTPUT FOR 46.9 IN. / 1190 MM

Beam Angles	15x15°					25x25°					35x35°					50x50°				
	Red	Green	Blue	White	All	Red	Green	Blue	White	All	Red	Green	Blue	White	All	Red	Green	Blue	White	All
Lumen / Foot	132	222	61	203	667	126	218	60	201	651	127	218	49	193	541	108	210	46	191	524
Lumen / Meter	435	729	200	666	2188	415	714	197	658	2137	418	714	160	635	1775	354	688	152	628	1721
Total Lumens	526	882	242	806	2648	502	864	238	796	2586	506	864	194	768	2148	428	832	184	760	2082

Acolyte does not warrant or represent that the information is free from errors or omission. The information may change without notice and Acolyte is not in any way liable for the accuracy of any information printed and stored or in any way interpreted or used.

DIMENSIONS / ACCESSORIES

DIMENSIONS

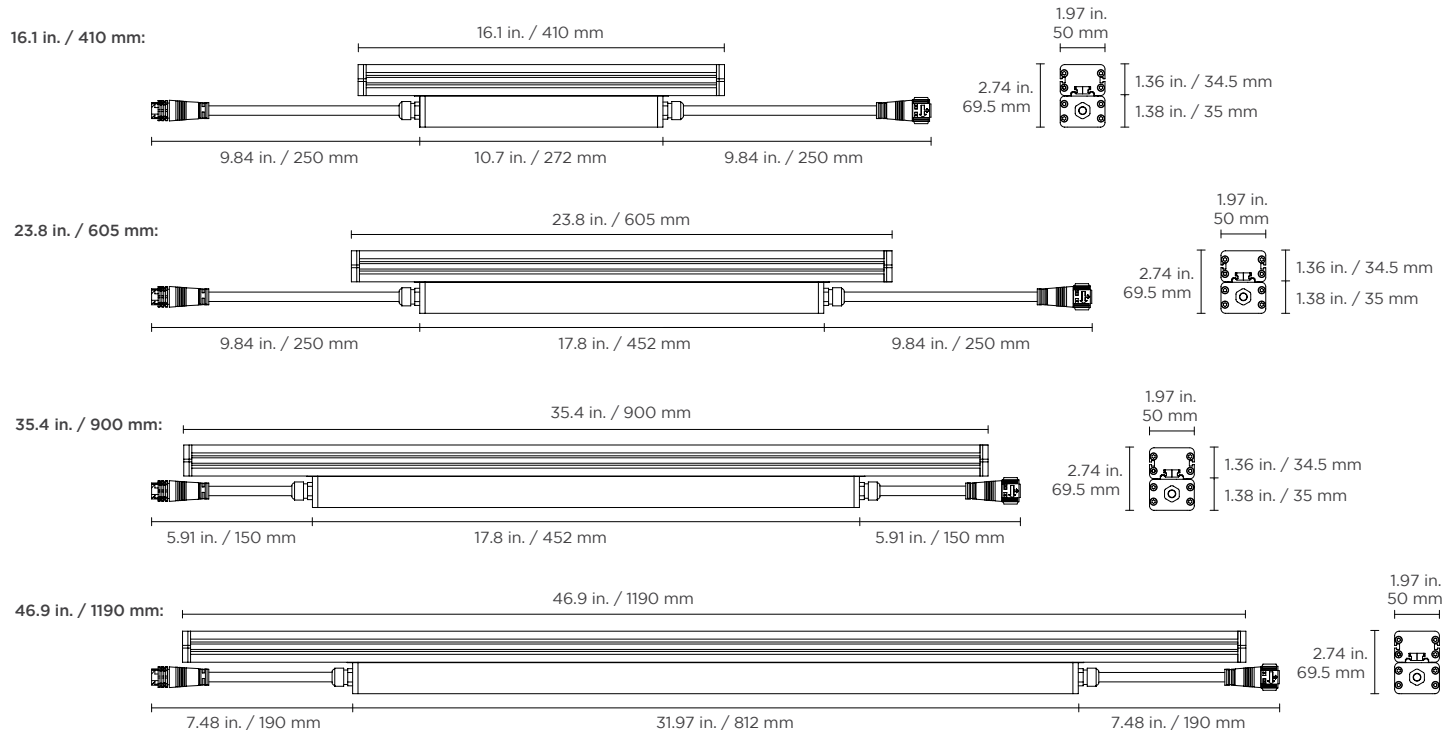

MOUNTING HARDWARE

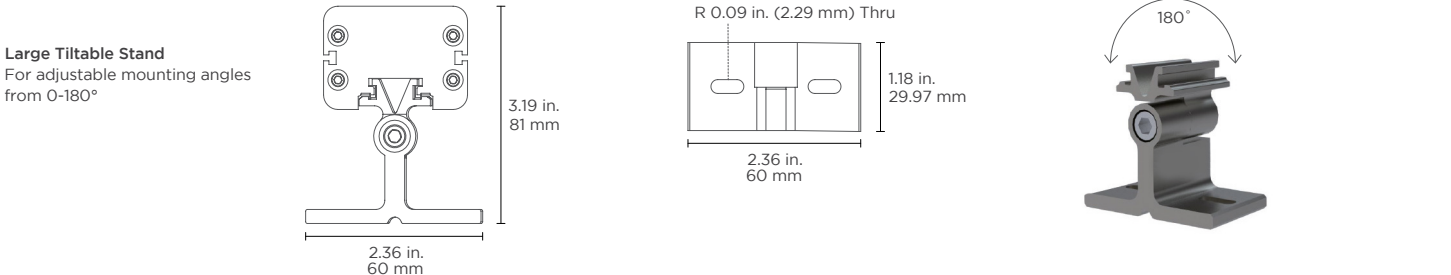

Mounting Arms

Small Mounting Arm Part Number: ARMORMNT0609  
 Large Mounting Arm Part Number: ARMORMNT1422

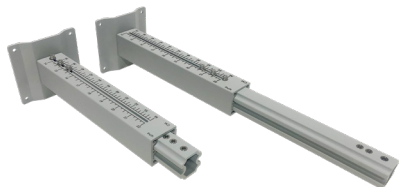

Adjustable mounts (in 2 sizes) help set desired angle and distance from lighting surface

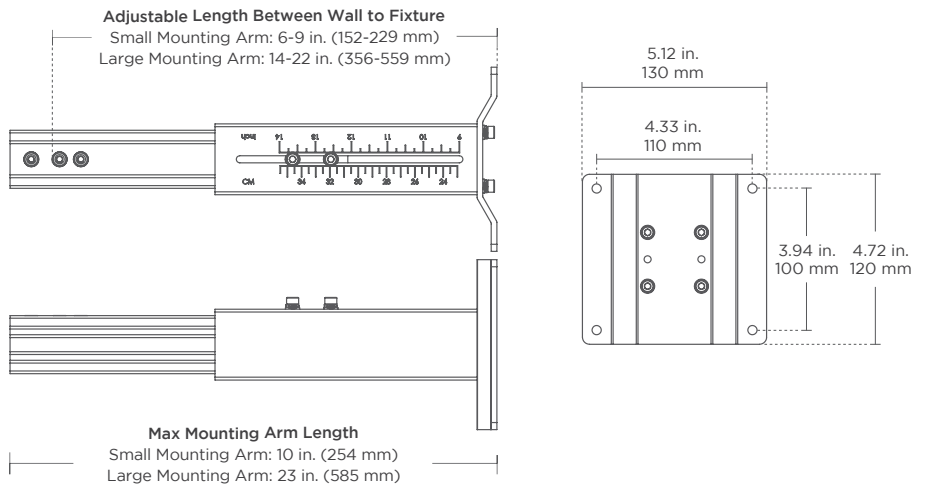

ACCESSORIES

**Symmetric Louver**

For glare reduction  
Note: This will affect beam angle



Part Number:  
MINILOUVRGBW410 (410 mm)  
MINILOUVRGBW605 (605 mm)  
MINILOUVRGBW900 (900 mm)  
MINILOUVRGBW1190 (1190 mm)

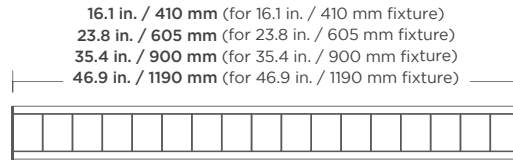

Not recommended for exterior applications

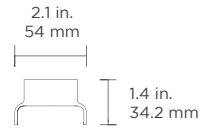

Side View

**Asymmetric Louver**

For glare reduction  
Note: This will affect beam angle



Part Number:  
MINILOUVRGBW410 (410 mm)  
MINILOUVRGBW605 (605 mm)  
MINILOUVRGBW900 (900 mm)  
MINILOUVRGBW1190 (1190 mm)

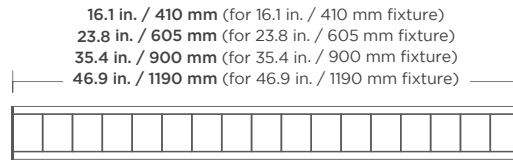

Not recommended for exterior applications

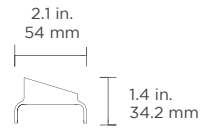

Side View

**Glare Shield**

To reduce glare or redirect light



Part Number:  
MINISHLD410 (410 mm)  
MINISHLD605 (605 mm)  
MINISHLD900 (900 mm)  
MINISHLD1190 (1190 mm)

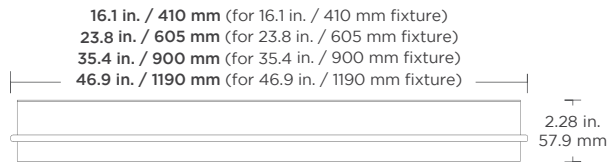

Adds 2.0 in. / 50.8 mm to the height of the fixture

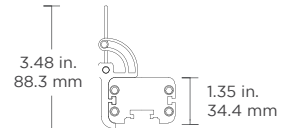

Side View

**6 Pin Cable with Female Connector to Bare Wire (Power)**

To bare wire for incoming power  
Lengths: 78.74 in. (2000 mm) and 19.7 ft (6000 mm)



Part Number:  
MINICBLFB6PIN2000 (6.6 ft / 2000 mm)  
MINICBLFB6PIN6000 (19.7 ft / 6000 mm)

**6 Pin Male To Female Jumper Cable**

To connect 6 pin male connector to 6 pin female connector  
Lengths: 39.4 in. (1000 mm) and 78.7 in. (2000 mm)  
(Consult factory for custom length)



Part Number:  
MINIJUMP6PINMK1000 (3.3 ft / 1000 mm)  
MINIJUMP6PINMK2000 (6.6 ft / 2000 mm)

**End Cap**

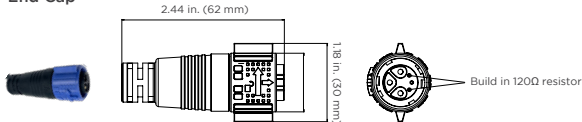

Part Number:  
MINIAC-CAPRGBW

CONNECTION / CONNECTORS

BASIC DMX WIRING

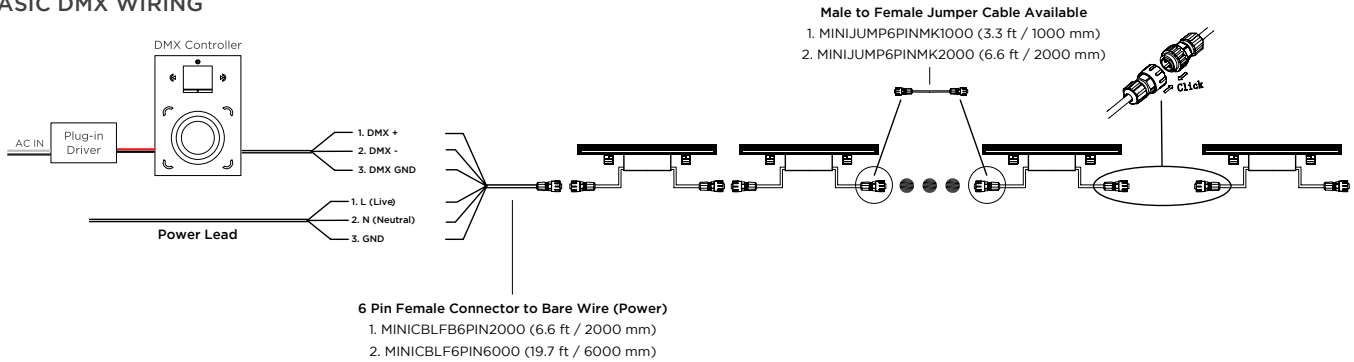

ADVANCED DMX WIRING

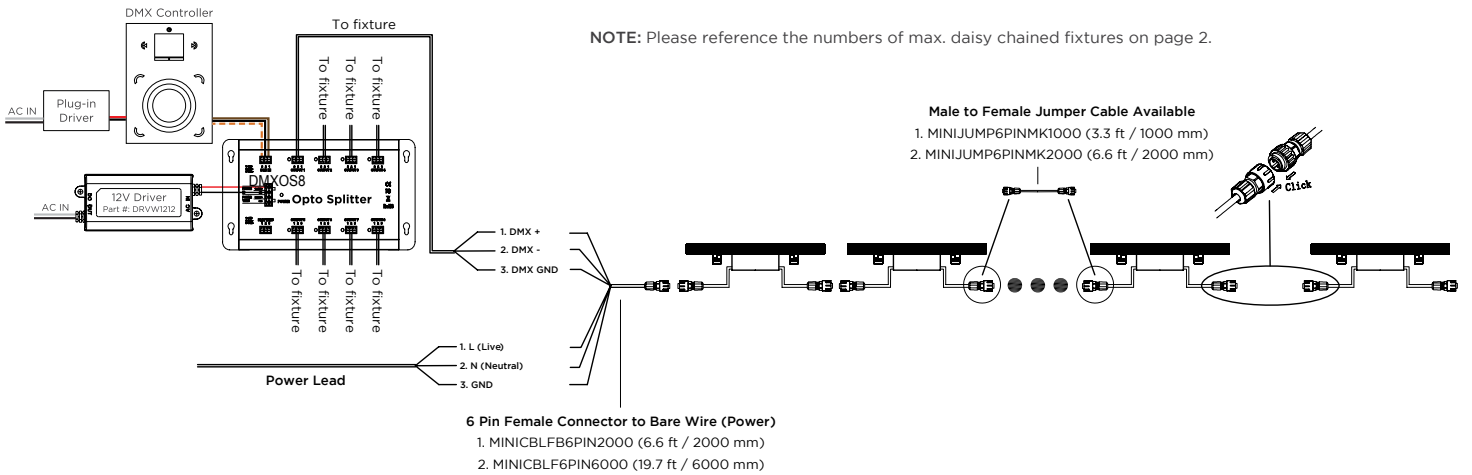

6-PIN CONNECTOR AND WIRE SPECS

Cable	Function	Pin ID	Wire Size	Wire Color (US)
Power Lead in / Power Extension	L (Line)	1	16AWG	Black
	N (Neutral)	2	16AWG	White
	GND (Ground)	3	16AWG	Green
DMX	DMX +	4	22AWG	Purple
	DMX -	5	22AWG	Gray
	DMX GND	6	22AWG	Yellow

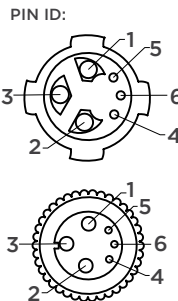

6-Pin Connector is used for the following cables:

1. Fixture in/out
2. MINIJUMP6PINMK1000
3. MINIJUMP6PINMK2000
4. MINICBLFB6PIN2000
5. MINICBLFB6PIN6000

Notes:

1. The top wiring diagram shows only typical connections. Actual wiring depends on the site configuration and installation.
2. The wire connection method shall be determined by local electrical codes and regulations. Wire nuts or screw terminal blocks are recommended for wire connection.
3. Actual number of wall washer can be connected may vary according to cable lengths and signal source.
4. Shield signal cables are recommended for signal protection.

REV.11FEB2025

GLOBAL HQ

320 Murray Hill Pkwy  
East Rutherford, NJ 07073  
U.S.  
T: (+1) 212 629 6830  
E: Sales-US@GENLEDBrands.com

EUROPEAN HQ

Hogeweyselaan 119  
1382 JK Weesp  
Netherlands  
T: (+31) 346 235 000  
E: SalesEurope@GENLEDBrands.com

MEINA HQ

PO Box 371378, #823, Building 4EA  
Dubai Airport Free Zone, Dubai, UAE  
T: (+971) 4 701 7901  
E: SalesMEINA@genlebrands.com

ASIA-PACIFIC HQ

Room 402, Building D  
Shenshi Tongchuang Science and Technology Park  
No. 16 Hongyin Road  
Xingqiang Community, Xihu Street  
Guangming District, Shenzhen, China 518107  
T: (+86) 755 8529 0710  
E: Sales-Pacific@GENLEDBrands.com