

ARMOR SERIES | RGBW AC MINI EXTERIOR LINEAR FIXTURES

RGBW AC Mini Linear fixtures feature an onboard driver. Available in RGBW with three distinct static white CCTs ranging from 3000K to 6500K, the RGBW AC Mini offers 4 optic beam angles and comes in 4 different lengths. You can daisy chain these fixtures for up to 68 feet at 120 VAC. Connect up to 32 fixtures per DMX controller. This addition to the Armor Series exterior product line is a fantastic solution for wall washing and grazing to create dramatic façade lighting. No remote drivers necessary!

GEL-FLUSH™ TECHNOLOGY

The RGBW AC Mini Linear fixture is manufactured with our Gel-Flush™ Technology. Developed with a special sealant from Dow Corning, this proprietary innovation prevents any breach from weather-related elements. No leaking. No condensation. Just clear, unobstructed beams of light.

Applications:

Commercial Museums
 Entertainment Public Spaces



IP67

ORDERING GUIDE

Category	Input Voltage	Length	Color	FWHM Beam Angle
MINI	AC			
MINI - Armor RGBW Mini	AC - AC 90-264V	16 - 16.1 in. (410 mm) 20 W	RGBW30 - RGBW+3000K	15 - 15°
		24 - 23.8 in. (605 mm) 30 W	RGBW40 - RGBW+4000K	25 - 25°
		36 - 35.4 in. (900 mm) 45 W	RGBW65 - RGBW+6500K	35 - 35°
		47 - 47.2 in. (1190 mm) 60 W		50 - 50°

OPTIONAL ACCESSORIES:

1.) Armor Series Mounting Arms:

Small: ARMORMNT0609
 Large: ARMORMNT1422

3.) Asymmetric Louver:

MINIALOUVRGBW410 (410 mm)
 MINIALOUVRGBW605 (605 mm)
 MINIALOUVRGBW900 (900 mm)
 MINIALOUVRGBW1190 (1190 mm)

5.) 6 Pin Male to Female Jumper Cable:

MINIJUMP6PINMK1000 (1000 mm)
 MINIJUMP6PINMK2000 (2000 mm)

7.) 3 Pin Cable with Female Connector to Bare Wire (DMX):

MINICLFB3PINLV2000 (2000 mm)
 MINICLFB3PINLV6000 (6000 mm)

2.) Symmetric Louver:

MINILOUVRGBW410 (410 mm)
 MINILOUVRGBW605 (605 mm)
 MINILOUVRGBW900 (900 mm)
 MINILOUVRGBW1190 (1190mm)

4.) Glare Shield:

MINISHLD410 (410 mm)
 MINISHLD605 (605 mm)
 MINISHLD900 (900 mm)
 MINISHLD1190 (1190 mm)

6.) 3 Pin Cable with Female Connector to Bare Wire (Power):

MINICLFB3PIN2000 (2000 mm)
 MINICLFB3PIN6000 (6000 mm)

8.) T-Connector (Power Input):

MINICBLINPUT336

AVAILABLE COLORS



RGBW



SPECIFICATIONS / DIMENSIONS / LUMEN DATA

Operating Voltage	AC 90-264V			
Length	16.1" / 410 mm	23.8" / 605 mm	35.4" / 900 mm	47.2" / 1190 mm
Power Consumption	20 W	30 W	45 W	60 W
LEDs per Fixture	10 LEDs	15 LEDs	24 LEDs	30 LEDs
Color / Temperature	RGBW+3000K, RGBW+4000K, RGBW+6500K			
LED Beam Angle	15°, 25°, 35°, 50°			
Max Daisy Chained Power	32 fixtures @ 120 VAC 32 fixtures @ 220-240 VAC	30 fixtures @ 120 VAC 32 fixtures @ 220-240 VAC	22 fixtures @ 120 VAC 30 fixtures @ 220-240 VAC	17 fixtures @ 120 VAC 24 fixtures @ 220-240 VAC
Control System	DMX			
LED Binning (SDCM)	3-Step MacAdam ellipse (White Channel Only)			
Ambient Temperature	-40° F to 122° F (-40° C to 50° C)			
Housing / Lens Materials	Housing: Extruded Aluminium / Lens: Clear UV Protected PMMA Cover: Tempered Glass End Caps: Extruded Aluminium / Brackets: Extruded Aluminium Housing, bracket, end cap material - 6063 high density aluminum alloy			
Connector	6 Pin Combined Power and DMX. 16 AWG Power / 22 AWG DMX			
Cable Length	11.81" / 300 mm			
Protection Rating	IP67			
Mounting Options	Large Tilttable Stand (180° adjustable), Mounting Arms (available in 2 different sizes)			
Impact Rating	IK08			
Lamp Life	50,000 hours			
Certifications	Luminaires - UL 1598, 3rd Ed., issued September 17, 2008, Rev. October 17, 2012 / Luminaires - CSA C22.2 No.250.0-08, 3rd Ed., issued September 17, 2008, Rev. October 17, 2012 (R2013)			
Fixture Color Finish	Anodized Silver			

LIGHT OUTPUT FOR 16.1" / 410 MM

Beam Angles	15°					25°					35°					50°				
	Red	Green	Blue	White	All	Red	Green	Blue	White	All	Red	Green	Blue	White	All	Red	Green	Blue	White	All
Color / Temp.	33	43	12	40	42	32	42	12	39	41	32	41	10	339	34	28	41	9	37	33
Lumen / Foot	33	43	12	40	42	32	42	12	39	41	32	41	10	339	34	28	41	9	37	33
Total Lumens	174.9	286.8	80	266.8	840	169.6	280.1	80	260.1	820	169.6	273.5	66.7	2261.1	680	148.4	273.5	60	246.8	660

LIGHT OUTPUT FOR 23.8" / 605 MM

Beam Angles	15°					25°					35°					50°				
	Red	Green	Blue	White	All	Red	Green	Blue	White	All	Red	Green	Blue	White	All	Red	Green	Blue	White	All
Color / Temp.	33	43	12	40	42	32	42	12	39	41	32	41	10	339	34	28	41	9	37	33
Lumen / Foot	33	43	12	40	42	32	42	12	39	41	32	41	10	339	34	28	41	9	37	33
Total Lumens	263	441	121	403	1324	251	432	119	398	1293	253	432	97	384	1074	214	416	92	378	1041

LIGHT OUTPUT FOR 35.4" / 900 MM

Beam Angles	15°					25°					35°					50°				
	Red	Green	Blue	White	All	Red	Green	Blue	White	All	Red	Green	Blue	White	All	Red	Green	Blue	White	All
Color / Temp.	33	43	12	40	42	32	42	12	39	41	32	41	10	339	34	28	41	9	37	33
Lumen / Foot	33	43	12	40	42	32	42	12	39	41	32	41	10	339	34	28	41	9	37	33
Total Lumens	422.4	688	192	640	2016	409.6	672	192	624	1968	409.6	656	160	624	1632	35834	656	144	592	1584

LIGHT OUTPUT FOR 47.2" / 1190 MM

Beam Angles	15°					25°					35°					50°				
	Red	Green	Blue	White	All	Red	Green	Blue	White	All	Red	Green	Blue	White	All	Red	Green	Blue	White	All
Color / Temp.	33	43	12	40	42	32	42	12	39	41	32	41	10	339	34	28	41	9	37	33
Lumen / Foot	33	43	12	40	42	32	42	12	39	41	32	41	10	339	34	28	41	9	37	33
Total Lumens	528	860	240	800	2520	512	840	240	780	2460	512	820	200	780	2040	448	820	180	740	1980

Acolyte does not warrant or represent that the information is free from errors or omission. The information may change without notice and Acolyte is not in any way liable for the accuracy of any information printed and stored or in any way interpreted or used.

DIMENSIONS / ACCESSORIES

DIMENSIONS

16.1 inches / 410 mm:

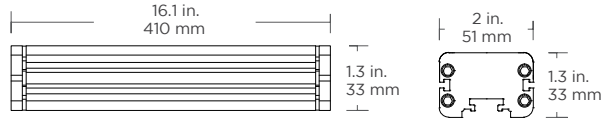

23.8 in. / 605 mm:

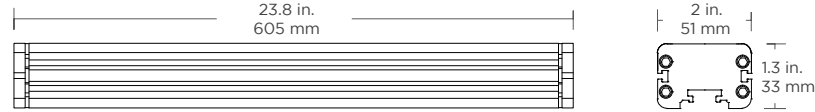

35.43 in. / 900 mm:

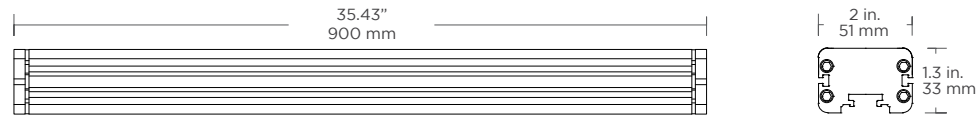

46.9 in. / 1190 mm:

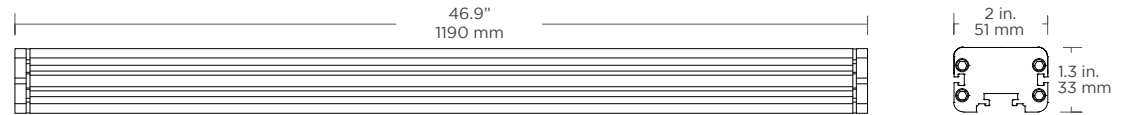

MOUNTING HARDWARE

Large Tiltable Stand
For adjustable mounting angles from 0-180°

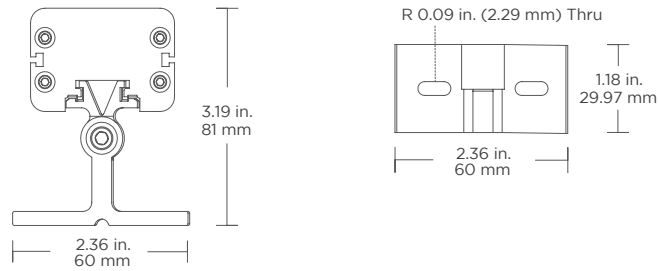

Mounting Arms

Small Mounting Arm Part Number: ARMORMNT0609
Large Mounting Arm Part Number: ARMORMNT1422

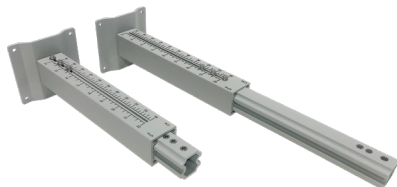

Armor Series Mounting Arm

Adjustable mounts (in 3 sizes) help set desired angle and distance from lighting surface

Adjustable Length Between Wall to Fixture

Small Mounting Arm: 6-9" (152-229 mm)
Large Mounting Arm: 14-22" (356-559 mm)

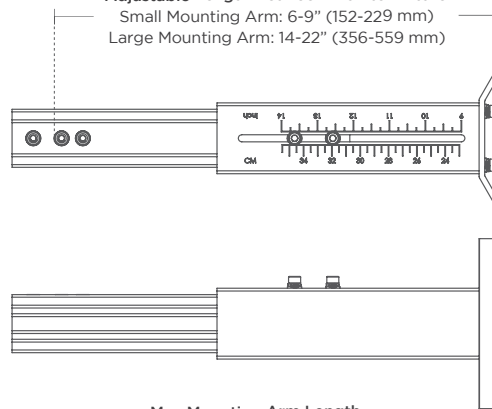

Max Mounting Arm Length

Small Mounting Arm: 10" (254 mm)
Large Mounting Arm: 23" (585 mm)

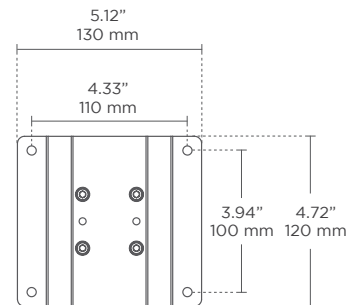

ACCESSORIES

Symmetric Louver

For glare reduction
Note: This will affect beam angle



Part Number:
MINILOUVRGBW410 (410 mm)
MINILOUVRGBW605 (605 mm)
MINILOUVRGBW900 (900 mm)
MINILOUVRGBW1190 (1190mm)

16.02 in./407 mm (for 16.10in/410mm fixture)
23.70 in./602 mm (for 23.80in/605mm fixture)
35.31 in./897 mm (for 35.43in/900mm fixture)
46.73 in./1187 mm (for 46.9in/1190mm fixture)

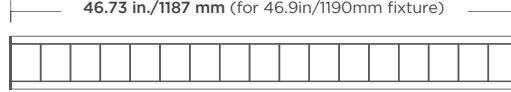

Not recommended for exterior applications

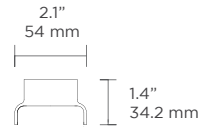

Side View

Asymmetric Louver

For glare reduction
Note: This will affect beam angle



Part Number:
MINIALOUVRGBW410 (410 mm)
MINIALOUVRGBW605 (605 mm)
MINIALOUVRGBW900 (900 mm)
MINIALOUVRGBW1190 (1190 mm)

16.02 in./407 mm (for 16.10in/410mm fixture)
23.70 in./602 mm (for 23.80in/605mm fixture)
35.31 in./897 mm (for 35.43in/900mm fixture)
46.73 in./1187 mm (for 46.9in/1190mm fixture)

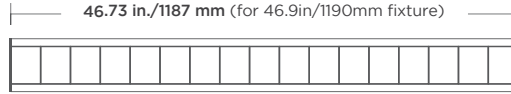

Not recommended for exterior applications

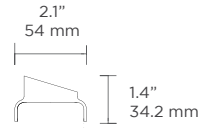

Side View

Glare Shield

To reduce glare or redirect light



Part Number:
MINISHLD410 (410 mm)
MINISHLD605 (605 mm)
MINISHLD900 (900 mm)
MINISHLD1190 (1190 mm)

16.02 in./407 mm (for 16.10in/410mm fixture)
23.70 in./602 mm (for 23.80in/605mm fixture)
35.31 in./897 mm (for 35.43in/900mm fixture)
46.73 in./1187 mm (for 46.9in/1190mm fixture)

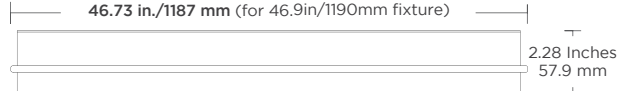

Adds 2.0" / 50.8 mm to the height of the fixture

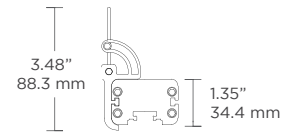

Side View

3 Pin Female Cable To Bare Wire

To bare wire for incoming power



Part Number:
MINICLFB3PIN2000 (6.6 ft / 2000 mm)
MINICLFB3PIN6000 (19.7 ft / 6000 mm)

6 Pin Male To Female Jumper Cable

To connect 6 pin male connector to 6 pin female connector

Lengths: 39.4 in. (1000 mm) and 78.7 in. (2000 mm)
(Consult factory for custom length)



Part Number:
MINIJUMP6PINMK1000 (3.3 ft / 1000 mm)
MINIJUMP6PINMK2000 (6.6 ft / 2000 mm)

3 Pin Female To Bare Wire DMX Input Cable

To bare wire for DMX controller



Part Number:
MINICLFB3PINLV2000 (6.6 ft / 2000 mm)
MINICLFB3PINLV6000 (19.7 ft / 6000 mm)

CONNECTION / CONNECTORS

DMX WIRING DIAGRAM:

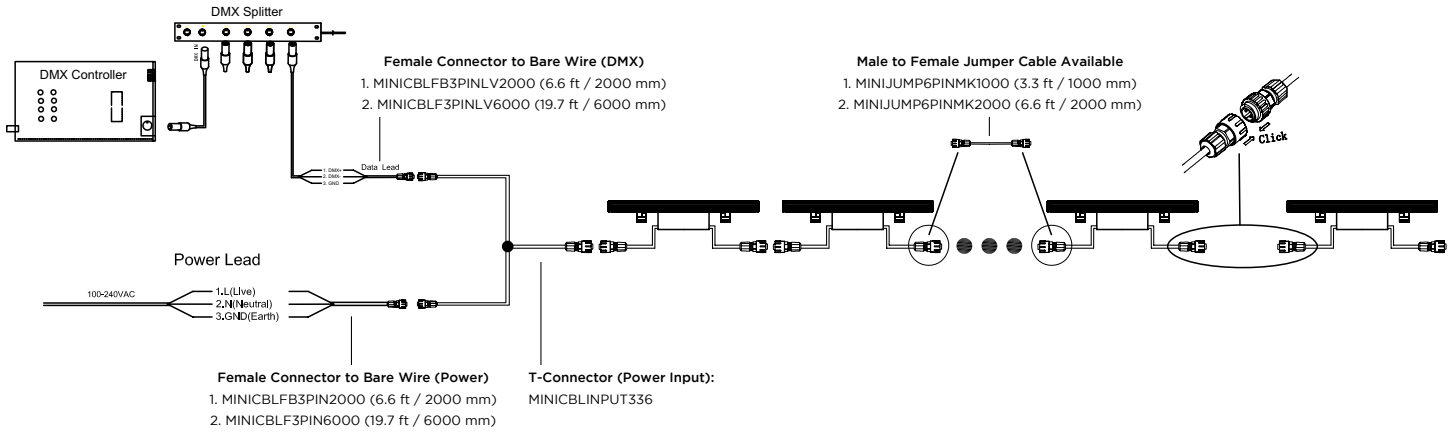

6-PIN CONNECTOR AND WIRE SPECS

Cable	Function	Pin ID	Wire Size	Wire Color (US)
Power Lead in / Power Extension	L (Line)	1	16AWG	Black
	N (Neutral)	2	16AWG	White
	GND (Ground)	3	16AWG	Green
DMX	DMX +	4	22AWG	Purple
	DMX -	5	22AWG	Gray
	GND	6	22AWG	Yellow

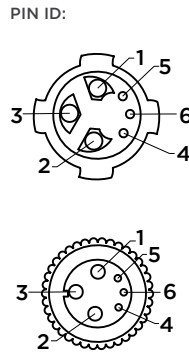

6-Pin Connector is used for the following cables:

1. Fixture in/out
2. MINICBLINPUT336 (Output Side)
3. MINIJUMP6PINMK1000
4. MINIJUMP6PINMK2000

3-PIN CONNECTOR AND WIRE SPECS

Cable	Function	Pin ID	Wire Size	Wire Color (US)
Power Lead In / Power Extension	L (Line)	1	16AWG	Black
	N (Neutral)	2	16AWG	White
	GND (Ground)	3	16AWG	Green
DMX	DMX +	1	22AWG	Purple
	DMX -	2	22AWG	Gray
	GND	3	22AWG	Yellow

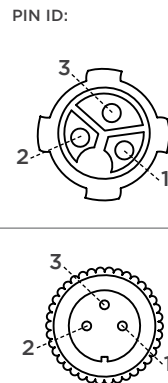

3-Pin Connector is used for the following cables:

1. MINICBLINPUT336 (Input side power)
2. MINICBLFB3PIN2000
3. MINICBLFB3PIN6000

3-Pin Connector is used for the following cables:

1. MINICBLINPUT336 (Input side DMX)
2. MINICBLFB3PINLV2000
3. MINICBLFB3PINLV6000

Notes:

1. The top wiring diagram shows only typical connections. Actual wiring depends on the site configuration and installation.
2. The wire connection method shall be determined by local electrical codes and regulations. Wire nuts or screw terminal blocks are recommended for wire connection.
3. Actual number of wall washer can be connected may vary according to cable lengths and signal source.
4. Shield signal cables are recommended for signal protection.