

ARMOR SERIES / AC MINI EXTERIOR LINEAR FIXTURE

AC Mini Linear fixtures feature an onboard driver. Available in 6 static white CCTs ranging from 2700K to 6000K, the AC Mini offers 5 optic beam angles and comes in 5 different lengths. You can daisy chain AC Mini fixtures for up to 112 feet at 120 VAC. This addition to the Armor Series exterior product line is a fantastic solution for wall washing and grazing to create dramatic façade lighting. No remote drivers necessary!

GEL-FLUSH™ TECHNOLOGY

The Armor Series AC Mini Linear fixture is manufactured with our Gel-Flush™ Technology. Developed with a special sealant from Dow Corning, this proprietary innovation prevents any breach from weather-related elements. No leaking. No condensation. Just clear, unobstructed beams of light.



Applications:

Commercial Museums
 Entertainment Public Spaces

ORDERING GUIDE

Category	CRI	Input Voltage	Length	Color Temperature	FWHM Beam Angle
MINI	80	AC			
MINI - Armor MINI	80 - 80+ CRI	AC - AC 120-277 V	12 - 12.3 in. (313 mm) 9 W 16 - 16.1 in. (410 mm) 12 W 24 - 23.8 in. (605 mm) 18 W 36 - 35.4 in. (900 mm) 27 W 47 - 46.9 in. (1190 mm) 36 W	27 - 2700K 30 - 3000K 35 - 3500K 40 - 4000K 50 - 5000K 60 - 6000K	10x60 - 10°x60° 10 - 10°x10° 20 - 20°x20° 25 - 25°x25° 50 - 50°x50°

OPTIONAL ACCESSORIES (See pages 3-5 for more information):

1.) Armor Series Mounting Arms:

Small: ARMORMNT0609
 Large: ARMORMNT1422

3.) Asymmetric Louver:

MINIALOUV313 (313 mm)
 MINIALOUV410 (410 mm)
 MINIALOUV605 (605 mm)
 MINIALOUV900 (900 mm)
 MINIALOUV1190 (1190 mm)

5.) 6 Pin Male to Female Jumper Cable:

MINIJUMP6PINMK1000 (1000 mm)
 MINIJUMP6PINMK2000 (2000 mm)

7.) T-Connector (Fixture Chain Splitter):

MINICBLTJOINT6PIN

2.) Symmetric Louver:

MINILOUV313 (313 mm)
 MINILOUV410 (410 mm)
 MINILOUV605 (605 mm)
 MINILOUV900 (900 mm)
 MINILOUV1190 (1190 mm)

4.) Glare Shield:

MINISHLD313 (313 mm)
 MINISHLD410 (410 mm)
 MINISHLD605 (605 mm)
 MINISHLD900 (900 mm)
 MINISHLD1190 (1190 mm)

6.) 6 Pin Cable with Female Connector to Bare Wire (Power):

MINICBLFB6PIN2000 (2000 mm)
 MINICBLFB6PIN6000 (6000 mm)

8.) End Cap:

MINIAC-CAPSW

AVAILABLE COLOR TEMPERATURES

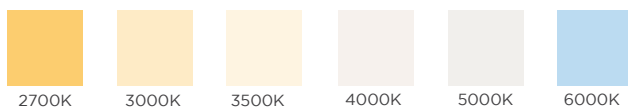

AVAILABLE BEAM ANGLES

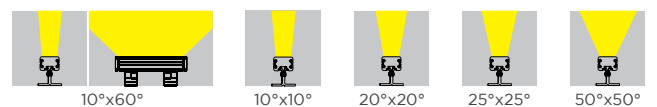

SPECIFICATIONS

Operating Voltage	120-277 V AC																								
Length	12.3 in. / 313 mm				16.1 in. / 410 mm				23.8 in. / 605 mm				35.4 in. / 900 mm				46.9 in. / 1190 mm								
Power Consumption	9 W				12 W				18 W				27 W				36 W								
Amperage	0.08 A @ 120V 0.04 A @ 230V 0.04 A @ 277V				0.11 A @ 120V 0.06 A @ 230V 0.05 A @ 277V				0.17 A @ 120V 0.09 A @ 230V 0.07 A @ 277V				0.25 A @ 120V 0.13 A @ 230V 0.11 A @ 277V				0.33 A @ 120V 0.17 A @ 230V 0.14 A @ 277V								
LEDs per Fixture	9 LEDs				12 LEDs				18 LEDs				27 LEDs				36 LEDs								
Color Temperature	2700K, 3000K, 3500K, 4000K, 5000K, 6000K																								
LED Beam Angle	10° x 10°	20° x 20°	25° x 25°	50° x 50°	10° x 60°	10° x 10°	20° x 20°	25° x 25°	50° x 50°	10° x 60°	10° x 10°	20° x 20°	25° x 25°	50° x 50°	10° x 60°	10° x 10°	20° x 20°	25° x 25°	50° x 50°	10° x 60°	10° x 10°	20° x 20°	25° x 25°	50° x 50°	10° x 60°
Lumen Output / Foot	1023	1035	969	795	1290	1023	1035	969	795	1290	1023	1035	969	795	1290	1023	1035	969	795	1290	1023	1035	969	795	1290
Total Lumens	1023	1035	969	795	1290	1329	1345	1260	1034	1526	2046	2070	1939	1591	1985	3069	3105	2907	2385	2977	4092	4140	2520	2068	3970
Max. Run Length	90 fixtures @ 120 VAC 127 fixtures @ 220-240 VAC 145 fixtures @ 277 VAC				68 fixtures @ 120 VAC 96 fixtures @ 220-240 VAC 111 fixtures @ 277 VAC				51 fixtures @ 120 VAC 72 fixtures @ 220-240 VAC 82 fixtures @ 277 VAC				37 fixtures @ 120 VAC 52 fixtures @ 220-240 VAC 59 fixtures @ 277 VAC				28 fixtures @ 120 VAC 40 fixtures @ 220-240 VAC 45 fixtures @ 277 VAC								
Control System	0-10 V																								
CRI	80+ CRI																								
LED Binning (SDCM)	3-step (80 CRI)																								
Binning Tolerance	+/- 100K																								
Ambient Temperature	-40° F to 122° F (-40° C to 50° C)																								
Housing / Lens Materials	Housing: Extruded Aluminium / Lens: Clear UV Protected PMMA Cover: Tempered Glass End Caps: Extruded Aluminium / Brackets: Extruded Aluminium Housing, bracket, end cap material - 6063 high density aluminum alloy																								
Connector	6 Pin Combined Power and Dimming. 16 AWG Power / 22 AWG Dimming																								
Cable Length	11.81 in. / 300 mm																								
Protection Rating	IP67																								
Impact Rating	IK08																								
Mounting Options	Large Tilttable Stand (180° adjustable), Mounting Arms (available in 2 different sizes)																								
Lamp Life	50,000 hours																								
Certifications	Luminaires - UL 1598, 3rd Ed., issued September 17, 2008, Rev. October 17, 2012 / Luminaires - CSA C22.2 No.250.0-08, 3rd Ed., issued September 17, 2008, Rev. October 17, 2012 (R2013)																								
Fixture Color Finish	Anodized Silver																								

* ALL LUMEN DATA IS FROM 3000K 80 CRI FIXTURES

SPECIFICATIONS / DIMENSIONS

DIMENSIONS

12.3 in. / 313 mm:

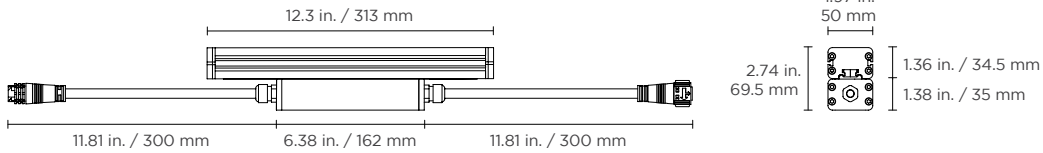

16.1 in. / 410 mm:

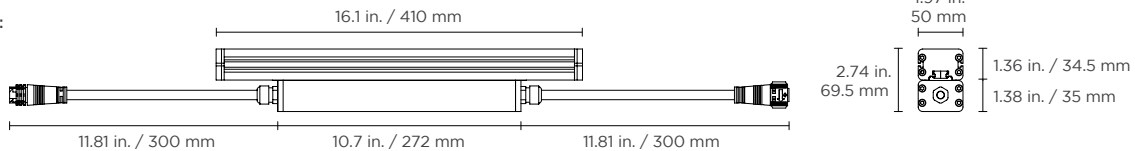

23.8 in. / 605 mm:

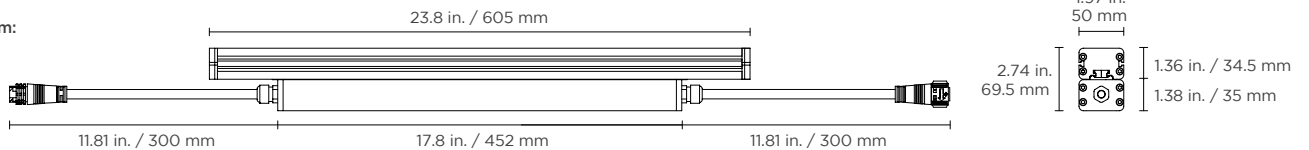

35.4 in. / 900 mm:

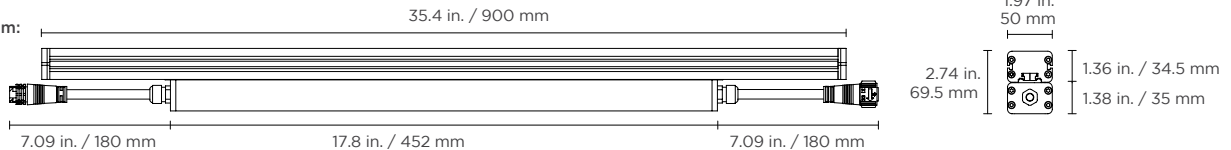

46.9 in. / 1190 mm:

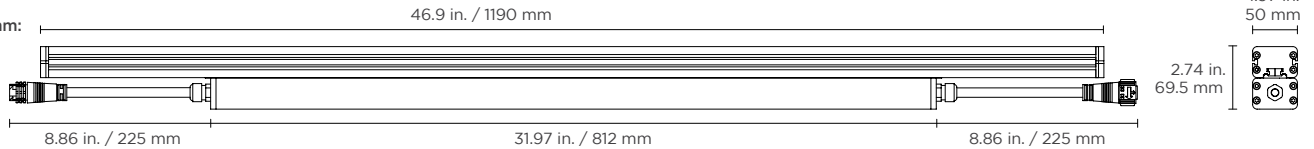

MOUNTING HARDWARE

Large Tilttable Stand
For adjustable mounting angles from 0-180°

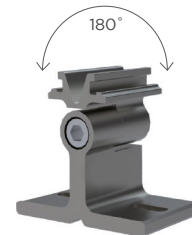
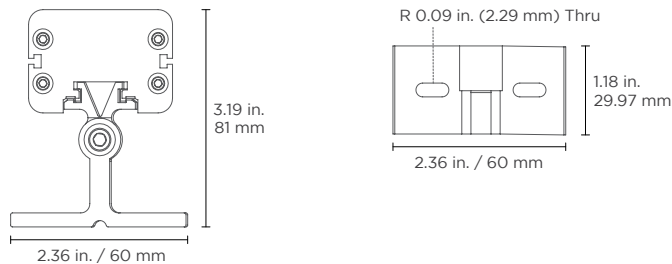

Mounting Arms

Small Mounting Arm Part Number: ARMORMNT0609
Large Mounting Arm Part Number: ARMORMNT1422

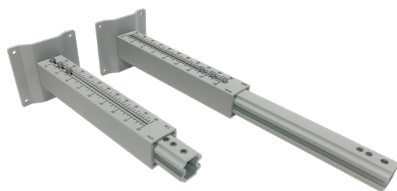

Adjustable mounts (in 3 sizes) help set desired angle and distance from lighting surface

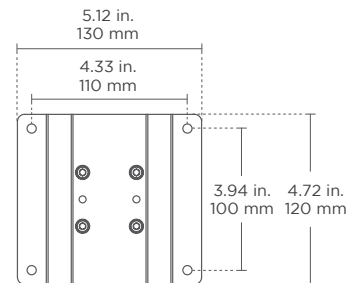
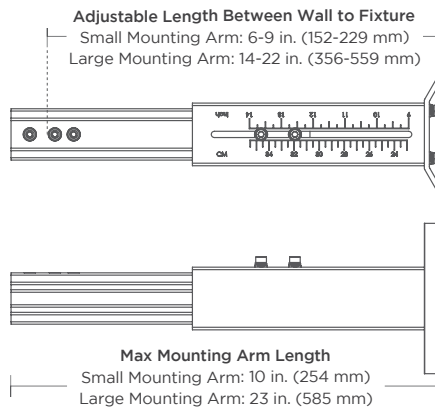

ACCESSORIES

Symmetric Louver

For glare reduction
Note: This will affect beam angle



Part Number:
MINILOUV313 (313 mm)
MINILOUV410 (410 mm)
MINILOUV605 (605 mm)
MINILOUV900 (900 mm)
MINILOUV1190 (1190 mm)

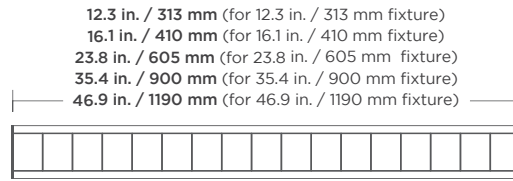

Not recommended for exterior applications

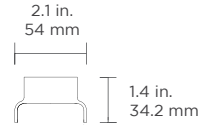

Side View

Asymmetric Louver

For glare reduction
Note: This will affect beam angle



Part Number:
MINIALOUV313 (313 mm)
MINIALOUV410 (410 mm)
MINIALOUV605 (605 mm)
MINIALOUV900 (900 mm)
MINIALOUV1190 (1190 mm)

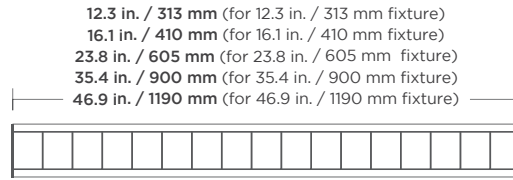

Not recommended for exterior applications

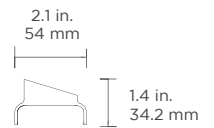

Side View

Glare Shield

To reduce glare or redirect light



Part Number:
MINISHLD313 (313 mm)
MINISHLD410 (410 mm)
MINISHLD605 (605 mm)
MINISHLD900 (900 mm)
MINISHLD1190 (1190 mm)

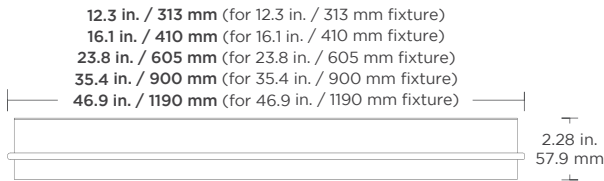

Adds 2.0 in. / 50.8 mm to the height of the fixture

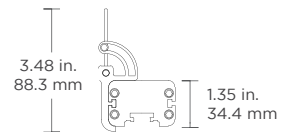

Side View

6 Pin Cable with Female Connector to Bare Wire (Power)

To bare wire for incoming power
Lengths: 78.74 in. (2000 mm) and 19.7 ft (6000 mm)



Part Number:
MINICBLFB6PIN2000 (6.6 ft / 2000 mm)
MINICBLFB6PIN6000 (19.7 ft / 6000 mm)

6 Pin Male To Female Jumper Cable

To connect 6 pin male connector to 6 pin female connector
Lengths: 39.4 in. (1000 mm) and 78.7 in. (2000 mm)
(Consult factory for custom length)



Part Number:
MINIJUMP6PINMK1000 (3.3 ft / 1000 mm)
MINIJUMP6PINMK2000 (6.6 ft / 2000 mm)

T-Connector (Fixture Chain Splitter)



Part Number:
MINICBLTJOINT6PIN

End Cap

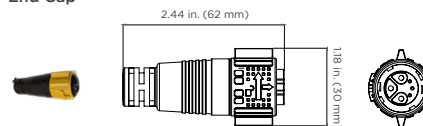

Part Number:
MINIAC-CAPSW

CONNECTION

STATIC WHITE WIRING DIAGRAM

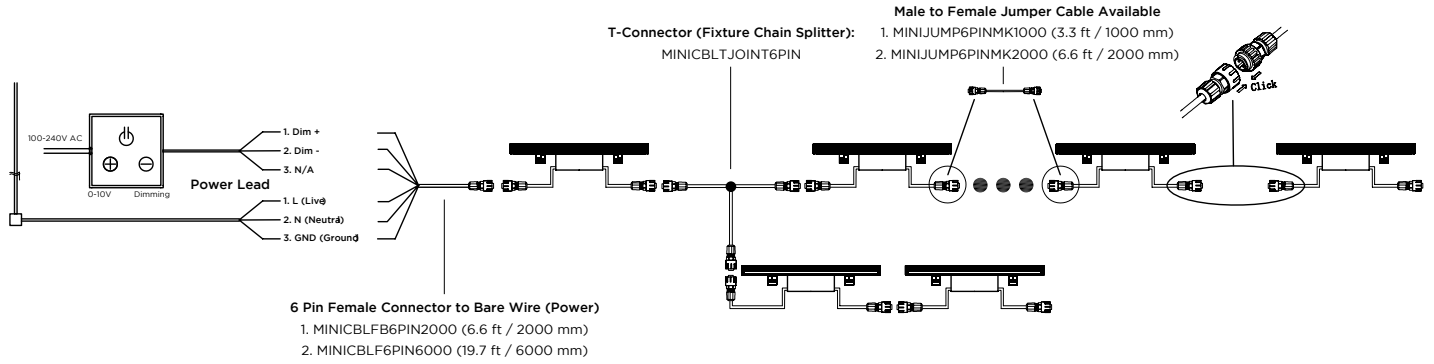

6-PIN CONNECTOR AND WIRE SPECS

Cable	Function	Pin ID	Wire Size	Wire Color (US)
Power Lead in / Power Extension	L (Line)	1	16AWG	Black
	N (Neutral)	2	16AWG	White
	GND (Ground)	3	16AWG	Green
Dimming	DIM +	4	22AWG	Purple
	DIM -	5	22AWG	Gray
	N/A	6	22AWG	Yellow

PIN ID:

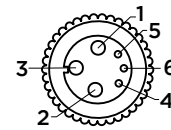
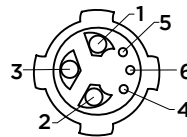

6-Pin Connector is used for the following cables:

1. Fixture in/out
2. MINICBLTJOINT6PIN
3. MINIJUMP6PINMK1000
4. MINIJUMP6PINMK2000
5. MINICBLFB6PIN2000
6. MINICBLFB6PIN6000

Notes:

1. The top wiring diagram shows only typical connections. Actual wiring depends on the site configuration and installation.
2. The wire connection method shall be determined by local electrical codes and regulations. Wire nuts or screw terminal blocks are recommended for wire connection.
3. Actual number of wall washer can be connected may vary according to cable lengths and signal source.
4. Shield signal cables are recommended for signal protection.