

ARMOR SERIES | MINI LINEAR INTERNATIONAL FIXTURES

With a small profile and 5 different optics options, you can use the Armor Series MINI Linear International fixture in several applications or one project. 6 color temperatures and 3 different lengths allow mixing and matching as needed to fit in any location. Choose the mounting bracket to match your application, from low space for vertical washing of facades, to the tilting bracket for a more focused control. This version is not compatible to be daisy chained with the regular USA MINI Linear fixtures. The Armor Series Mini Linear International comes with a three-year warranty.



GEL-FLUSH™ TECHNOLOGY

The Armor Series MINI Linear International fixture is manufactured with our Gel-Flush™ Technology. This proprietary innovation prevents breaches from any weather-related elements. Acolyte exterior products are guaranteed to never leak, condensate, or be breached by any environmental elements. This results in a clear and unobstructed beam of light from our fixtures. No more water beads changing and/or refracting the specified beam angles!



Applications:

Commercial Entertainment Museums Public Spaces



IP66

ORDERING GUIDE

Category	CRI	Voltage	Length	Color Temp	FWHM Beam Angle	Mounting Option
MINI		24				
MINI - Armor MINI	80 - 80+ CRI	24 - 24 V DC	0.2 - 185 mm / 7.3 in. (3 W)	27 - 2700K	10x40 - 10x40°	SI - Snap-In
	90 - 90+ CRI		0.5 - 500 mm / 19.7 in. (9 W)	30 - 3000K	15 - 15°	TS - Tilttable Stand
			1.0 - 1000 mm / 39.4 in. (18 W)	35 - 3500K	20 - 20°	
			40 - 4000K	35 - 35°		
			50 - 5000K	50 - 50°		
			60 - 6000K			

OPTIONAL ACCESSORIES:

1.) Armor Series Mounting Arms:

Small: ARMORMNT0609
Large: ARMORMNT1422

2.) Symmetric Louver:

MINILOUV185 (185 mm)
MINILOUV500 (500 mm)
MINILOUV1000 (1000 mm)

3.) Asymmetric Louver:

MINIALOUV185 (185 mm)
MINIALOUV500 (500 mm)
MINIALOUV1000 (1000 mm)

4.) Glare Shield:

MINISHLD185 (185 mm)
MINISHLD500 (500 mm)
MINISHLD1000 (1000 mm)

5.) 2 Pin Male to Female Jumper Cable:

MINIJUMPMF1000 (1000 mm)
MINIJUMPMF2000 (2000 mm)

6.) 2 Pin Female Cable to Bare Wire:

MINICBLFB300 (300 mm)
MINICBLFB500 (500 mm)
MINICBLFB1000 (1000 mm)
MINICBLFB2000 (2000 mm)

DRIVERS:

96 W Non-dimming Driver



Driver Part No.: DRVW2496

0-10V Dimmable Waterproof Drivers



96W Part No.: DRVW249610P
288W Part No.: DRVW2428810P

ELV/MLV Dimmable Drivers



60W Part No.: DRVW2460ELVMLV
96W Part No.: DRVW2496ELVMLV
150W Part No.: DRVW24150ELVMLV
300W Part No.: DRVW24300ELVMLV

AVAILABLE COLOR TEMPERATURES



SPECIFICATIONS

Operating Voltage	24 V DC		
Length	185 mm / 7.3 in.	500 mm / 19.7 in.	1000 mm / 39.4 in.
Power Consumption	3 W	9 W	18 W
LEDs per Fixture	5 LEDs	15 LEDs	30 LEDs
Amperage	0.2 A	0.625 A	1.25 A
Color Temperature	2700K, 3000K, 3500K, 4000K, 5000K, 6000K		
LED Beam Angle	15°, 20°, 35°, 50°, 10°x40°		
Lumen Output / Meter	2952.4		
Lumen Output / Foot	900.12		
Total Lumens	570.6	1476.2	2952.4
Max. Run Length	14 fixtures	8 fixtures	4 fixtures
Weight	0.48 kg / 1.06 lb	0.85 kg / 1.87 lb	1.2 kg / 2.65 lb
Control System	0-10V, DALI		
CRI	80+ or 90+CRI		
LED Binning (SDCM)	3-step (80 CRI) or 2-step (90 CRI)		
Binning Tolerance	+/- 100K		
Ambient Temperature	-40° C to 50° C (-40° F to 122° F)		
Housing / Lens Materials	Housing: Extruded Aluminium / Lens: Clear UV Protected PMMA Cover: Tempered Glass End Caps: Extruded Aluminium / Brackets: Extruded Aluminium Housing, bracket, end cap material - 6063 high density aluminum alloy		
Connector	2 pin power connector		
Cable Length	300 mm (11.81 in.)		
Protection Rating	IP66		
Impact Rating	IK08		
Mounting Options	Snap-In Clip, Tilttable Stand (140° adjustable), Large Tilttable Stand (180° adjustable), Mounting Arms (available in 2 different sizes)		
Lamp Life	50,000 hours		
Certifications	CE, ETL / Luminaires - UL 1598, 3rd Ed., issued September 17, 2008, Rev. October 17, 2012 / Luminaires - CSA C22.2 No.250.0-08, 3rd Ed., issued September 17, 2008, Rev. October 17, 2012 (R2013)		
Fixture Color Finish	Anodized Silver		

* ALL LUMEN DATA IS FROM 2700K 80 CRI FIXTURES.

DIMENSIONS / MOUNTING HARDWARE:

185 mm / 7.3 in.:

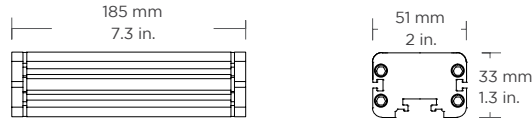

500 mm / 19.7 in.:

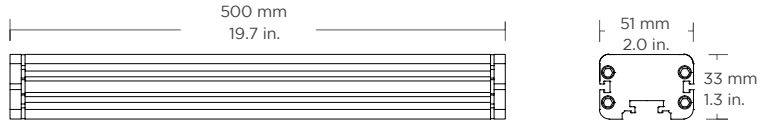

1000 mm / 39.4 in.:

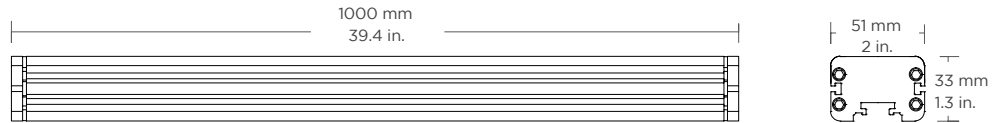

MOUNTING HARDWARE

Snap-in Clip

For narrow installations where mounting clips need to be installed first

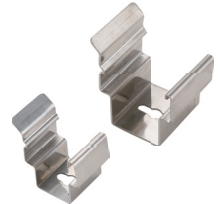
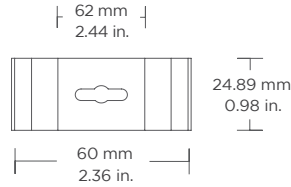
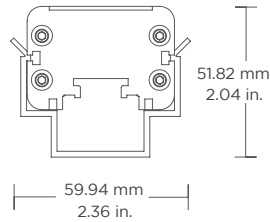

Tiltable Stand

For adjustable mounting angles up to 140°

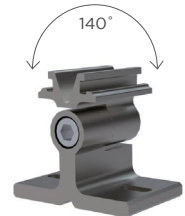
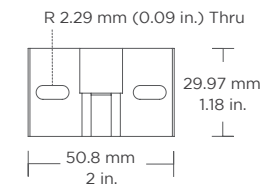
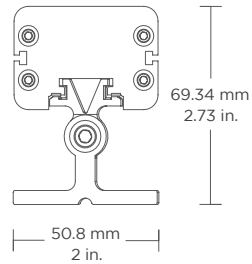

Large Tiltable Stand

For adjustable mounting angles up to 180°

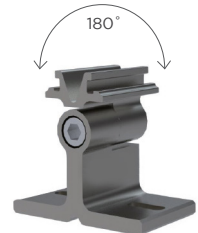
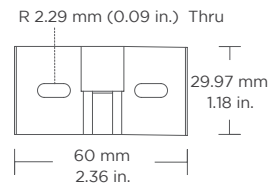
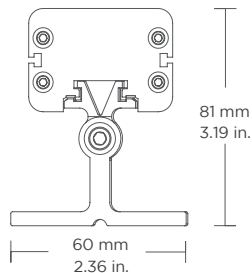

MOUNTING HARDWARE / ACCESSORIES

MOUNTING HARDWARE

Mounting Arms

Small Mounting Arm Part Number: ARMORMNT0609
Large Mounting Arm Part Number: ARMORMNT1422

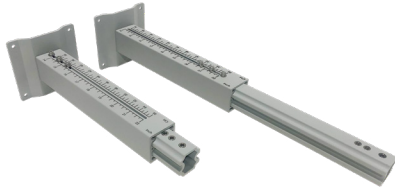

Armor Series Mounting Arm

Adjustable mounts (in 3 sizes) help set desired angle and distance from lighting surface

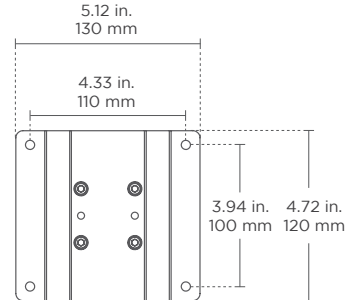
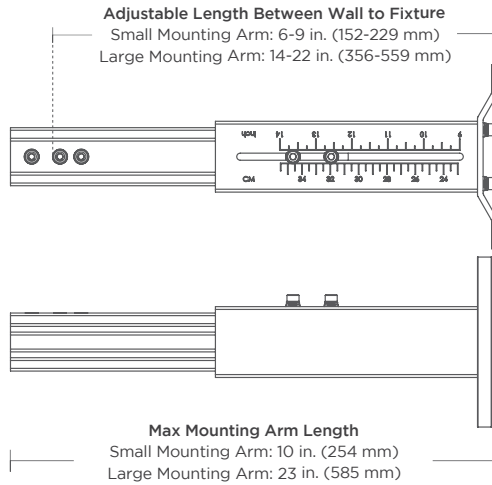

ACCESSORIES

Part Number: MINILOUV



Louver

For glare reduction
Note: This will affect beam angle

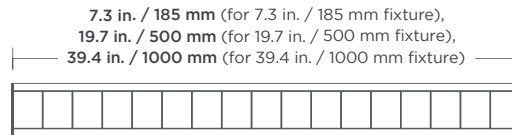

Not recommended for exterior applications

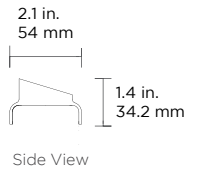

Part Number: MINILOUV



Asymmetric Louver

For glare reduction
Note: This will affect beam angle

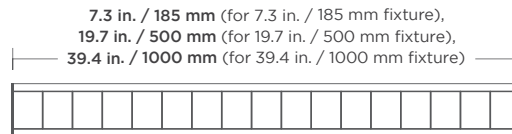

Not recommended for exterior applications

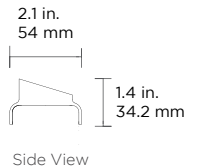

Part Number: MINISHLD



Glare Shield

To reduce glare or redirect light

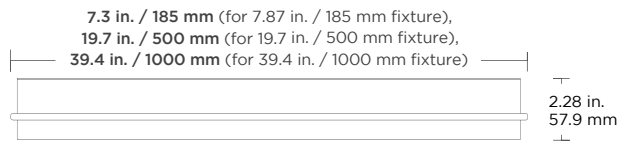

Adds 2.0 in. / 50.8 mm to the height of the fixture

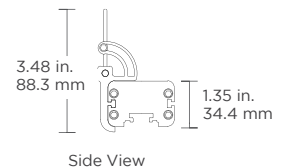

Default cable length on fixture is 11.81 in. / 30 cm



2 Pin Female Cable To Bare Wire
To bare wire for incoming power

- MINICBLFB300 (300 mm)
- MINICBLFB500 (500 mm)
- MINICBLFB1000 (1000 mm)
- MINICBLFB2000 (2000mm)



2 Pin Male To Female Jumper Cable
To connect 2 pin male connector to 2 pin female connector

- MINIJUMPMF1000 (1000 mm)
- MINIJUMPMF2000 (2000 mm)
- *Consult factory for custom length

CONNECTION

NON DIMMING:

CASE 1.

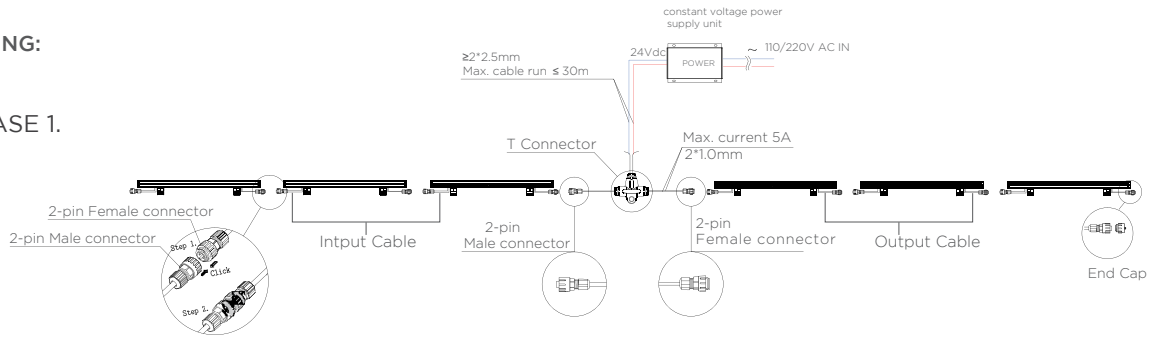

CASE 2.

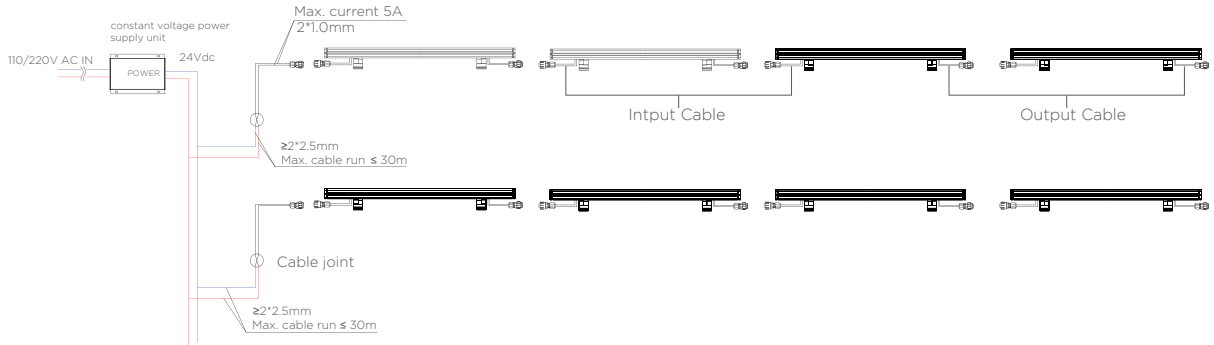

0-10V DIMMING:

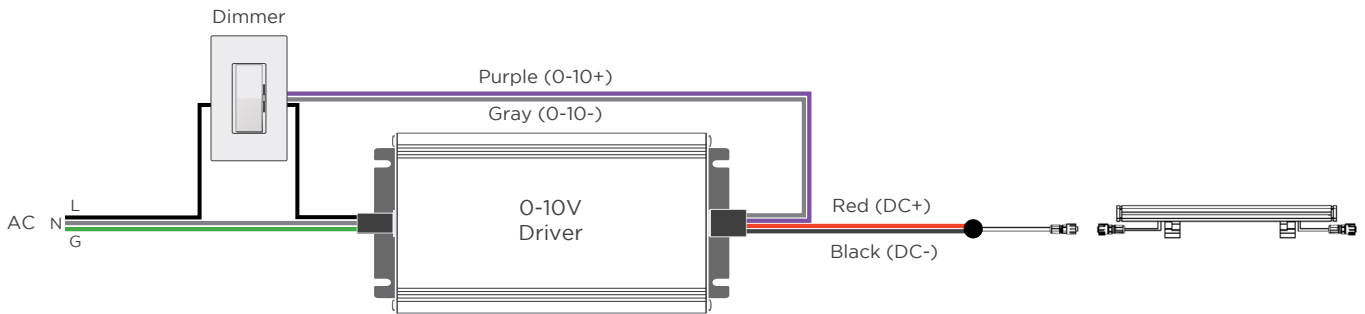

CONNECTION

DALI DIMMING:

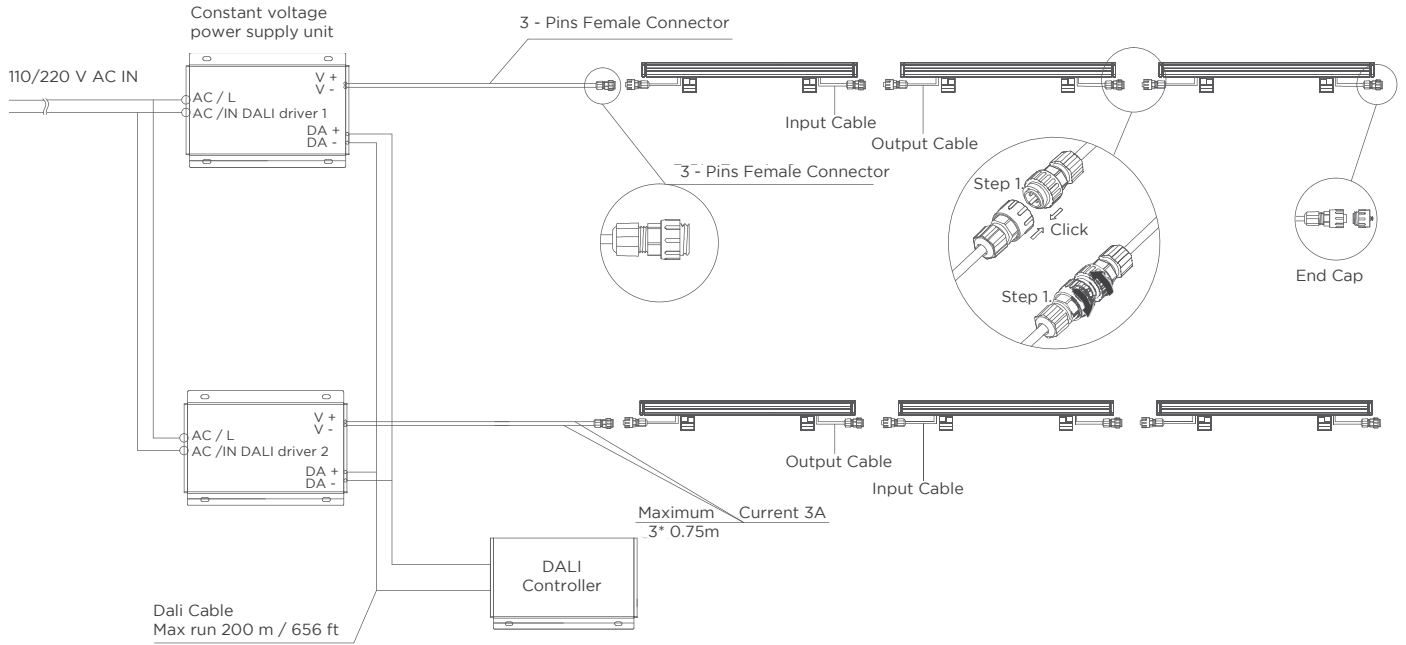

CONNECTORS:

