



Date _____ Project _____

Notes _____

ARMOR SERIES | RGBW MINI LINEAR

Armor Series RGBW Mini Linear fixtures offer a small, sleek anodized aluminum profile with four premium optics options designed for exterior applications. Powerful RGBW LEDs let you blend and change colors for wall washing and grazing effects. Create specific hues for holidays and events or design lighting with signature corporate colors. Choose from our traditional 24 VDC design or 90-264 VAC with an onboard driver! Three standard lengths allow mixing and matching as needed to fit any project. Select the mounting style suitable for your design, from tilting stands for focused beam angles in tight spaces to sturdy mounting arms for rock-solid light. RGBW Mini Linear fixtures come with a three-year warranty.

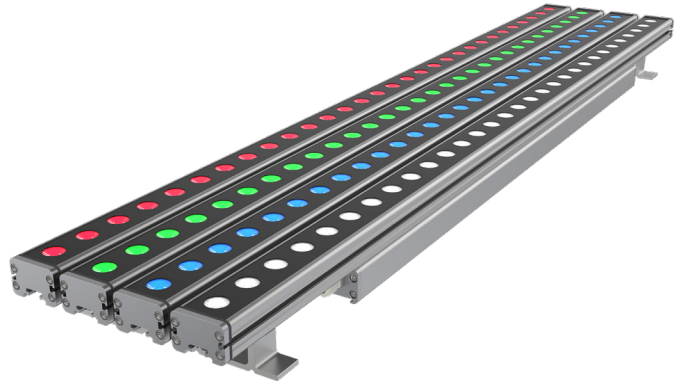

GEL-FLUSH™ TECHNOLOGY

The Armor Series Mini Linear fixture is manufactured with GelFlush™ Technology. This proprietary innovation uses a special Dow Corning sealant to protect your lighting from the elements. With Acolyte's Armor Series, there's no leaking and no condensation -- just clear, unobstructed beams of light!



ORDERING GUIDE (FOR DC MODELS)

Category	Length	Color	FWHM Beam Angle	
MINI				
MINI - Armor RGBW MINI	16 - 16.1 in. / 410 mm (20 W) 47 - 46.9 in. / 1190 mm (60 W) 24 - 23.8 in. / 605 mm (30 W)	RGBW30 - RGB+3000K RGBW65 - RGB+6500K RGBW40 - RGB+4000K	15 - 15x15° 35 - 35x35° 25 - 25x25° 50 - 50x50°	

ORDERING GUIDE (FOR AC MODELS)

Category	Input Voltage	Length	Color	FWHM Beam Angle	
MINI	AC				
MINI - Armor RGBW MINI	AC - 90-264 VAC	16 - 16.1 in. / 410 mm (20 W) 47 - 46.9 in. / 1190 mm (60 W) 24 - 23.8 in. / 605 mm (30 W)	RGBW30 - RGB+3000K RGBW65 - RGB+6500K RGBW40 - RGB+4000K	15 - 15x15° 35 - 35x35° 25 - 25x25° 50 - 50x50°	

OPTIONAL ACCESSORIES:

- | | | | | | |
|--|---|--------------------|---|--------------------|--|
| <p>1.) Armor Series Mounting Arms:
Small: ARMORMNT0609
Large: ARMORMNT1422</p> <p>2.) Glare Shield:
MINISHLD410 (410 mm)
MINISHLD605 (605 mm)
MINISHLD1190 (1190 mm)</p> | <p>3.) Symmetric Louver:
MINILOUVRGBW410 (410 mm)
MINILOUVRGBW605 (605 mm)
MINILOUVRGBW1190 (1190 mm)</p> <p>4.) Asymmetric Louver:
MINIALOUVRGBW410 (410 mm)
MINIALOUVRGBW605 (605 mm)
MINIALOUVRGBW1190 (1190 mm)</p> | For DC models only | <p>5.) 2 Pin Male to 2 Pin Female Jumper Cable:
MINIJUMPMF1000 (1000 mm)
MINIJUMPMF2000 (2000 mm)</p> <p>6.) 2 Pin Female Cable to Bare Wire:
MINICBLFB300 (300 mm)
MINICBLFB500 (500 mm)
MINICBLFB1000 (1000 mm)
MINICBLFB2000 (2000 mm)</p> <p>7.) 3 Pin Female to Bare Wire DMX Cable:
MINIDMXFB500 (500 mm)</p> <p>8.) 3 Pin Male to 3 Pin Female DMX Jumper Cable:
MINIDMXMF1000 (1000 mm)
MINIDMXMF2000 (2000 mm)</p> | For AC models only | <p>9.) Power Connector End Cap
MINIDC-CAP2</p> <p>10.) DMX Connector End Cap
MINIDC-CAP3</p> <p>10.) 6 Pin Male to Female Jumper Cable:
MINIJUMP6PINMK1000 (1000 mm)
MINIJUMP6PINMK2000 (2000 mm)</p> <p>11.) 6 Pin Cable with Female Connector to Bare Wire (Power):
MINICBLFB6PIN2000 (2000 mm)
MINICBLFB6PIN6000 (6000 mm)</p> <p>12.) End Cap:
MINIAC-CAPRGBW</p> |
|--|---|--------------------|---|--------------------|--|

AVAILABLE COLORS



RGBW

AVAILABLE BEAM ANGLES

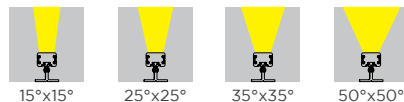

15°x15°

25°x25°

35°x35°

50°x50°

GLOBAL HQ

320 Murray Hill Pkwy
East Rutherford, NJ 07073
U.S.
T: (+1) 212 629 6830
E: Sales-US@GENLEDBrands.com

EUROPEAN HQ

Hogeweyselaan 119
1382 JK Weesp
Netherlands
T: (+31) 346 235 000
E: SalesEurope@GENLEDBrands.com

MEINA HQ

PO Box 371378, #823, Building 4EA
Dubai Airport Free Zone
Dubai, UAE
T: (+971) 4 701 7901
E: SalesMEINA@genlebrands.com









ASIA-PACIFIC HQ

Room 402, Building D
Shenshi Tongchuang Science and Technology Park
No. 16 Hongyin Road
Xingqiang Community, Xinhui Street
Guangming District, Shenzhen, China 518107
T: (+86) 755 8529 0710
E: Sales-Pacific@GENLEDBrands.com

SPECIFICATIONS

Operating Voltage	24 VDC			90-264 VAC		
Colors	RGBW (3000K, 4000K, 6500K)					
Beam Angles	15x15°, 25x25°, 35x35°, 50x50°					
Length	16.1 in. / 410 mm	23.8 in. / 605 mm	46.9 in. / 1190 mm	16.1 in. / 410 mm	23.8 in. / 605 mm	46.9 in. / 1190 mm
Power Consumption	20 W	30 W	60 W	20 W	30 W	60 W
LEDs per Fixture	10 LEDs	15 LEDs	33 LEDs	10 LEDs	15 LEDs	33 LEDs
Amperage	0.83 A	1.25 A	2.5 A	0.17 A @ 120 V 0.09 A @ 230 V	0.26 A @ 120 V 0.14 A @ 230 V	0.52 A @ 120 V 0.27 A @ 230 V
Max. Run Length	6 fixtures	4 fixtures	2 fixtures	10 fixtures @ 120 V 8 fixtures @ 230 V	10 fixtures @ 120 V 8 fixtures @ 230 V	10 fixtures @ 120 V 8 fixtures @ 230 V
Weight	3.41 lb / 1.55 kg	4.95 lb / 2.25 kg	6.82 lb / 3.1 kg	4.22 lb / 1.92 kg	6.36 lb / 2.89 kg	11.33 lb / 5.15 kg
Control System	DMX					
LED Binning (SDCM)	3-step (white channel only)					
Binning Tolerance	+/- 100K					
Ambient Temperature	-40 – 122 °F (-40 – 50 °C)					
Housing / Lens Materials	Housing: Extruded Aluminium / Lens: Clear UV Protected PMMA Cover: Tempered Glass End Caps: Extruded Aluminium / Brackets: Extruded Aluminium Housing, bracket, end cap material – 6063 high density aluminum alloy					
Connector	2 pin power connector / 3 pin DMX signal connector			6 Pin Combined Power and DMX. 16 AWG Power / 22 AWG DMX		
Cable Length	11.81 in. / 300 mm					
Protection Rating	IP67					
Impact Rating	IK07					
Mounting Options	Large Tilttable Stand (180° adjustable), Mounting Arms (available in 2 different sizes)					
Lifetime (L70 reported)	50,000 hours					
Certifications	CE / Luminaires – UL 1598, 3rd Ed., issued September 17, 2008, Rev. October 17, 2012 / Luminaires – CSA C22.2 No.250.0-08, 3rd Ed., issued September 17, 2008, Rev. October 17, 2012 (R2013)					
Fixture Color Finish	Anodized silver					

DRIVERS (FOR DC MODELS) / INTERFACE:

0-10V/ELV/MLV 3-IN-1	DIMMABLE ELECTRONIC DRIVERS	NON-DIMMING ELECTRONIC DRIVERS	INTERFACE
 <p>60W, 96W, 288W 0-10V/ELV/MLV 3-in-1 Dimmable Drivers</p> <p>Part No.:</p> <ul style="list-style-type: none"> • DRVW2460TRIO10 (60 W)* • DRVW2496TRIO10 (96 W)* • DRVW24288TRIO10 (288 W)* 	 <p>60W Dimmable Drivers</p> <p>Part No.:</p> <ul style="list-style-type: none"> • DRV2460ELV* 	 <p>60W, 96W Non-Dimming Compact Drivers</p> <p>Part No.:</p> <ul style="list-style-type: none"> • DRV2460C (60 W)* • DRV2496C (96 W)* 	 <p>5 Channel DMX Decoder</p> <p>Part No.:</p> <ul style="list-style-type: none"> • DMXINF5
ATHENA WIRELESS COMPATIBLE	CASAMBI COMPATIBLE DRIVERS	DIMMABLE DALI-2 DRIVERS	DIMMABLE DALI-2 DRIVERS
 <p>94W Athena Wireless Compatible Drivers</p> <p>Part No.:</p> <ul style="list-style-type: none"> • DRVW2494ATH1CH (1 channel)* • DRVW2494ATH2CH (2 channel)* 	 <p>100W & 200W Casambi Compatible 4 Channel Drivers</p> <p>Part No.:</p> <ul style="list-style-type: none"> • DRVW24100CAS4CH (100 W)* • DRVW24200CAS4CH (200 W) 	 <p>96W Dimmable DALI-2 DT6 D4I & DT8 D4I Drivers</p> <p>Part No.:</p> <ul style="list-style-type: none"> • DRVW2496DALI1CH (1 channel)* • DRVW2496DALI2CH (2 channel)* 	 <p>75W, 150W, 240W DALI-2 Dimmable Drivers</p> <p>Part No.:</p> <ul style="list-style-type: none"> • DRVW2475DALI1CH (75 W, 1 channel)* • DRVW24150DALI1CH (150 W, 1 channel)* • DRVW24240DALI1CH (240 W, 1 channel)* • DRV24150DALI2CH (150 W, 2 channels)* • DRV24150DALI4CH (150 W, 4 channels)

* Must be used with a interface/decoder

Acolyte does not warrant or represent that the information is free from errors or omission. The information may change without notice and Acolyte is not in any way liable for the accuracy of any information printed and stored or in any way interpreted or used.

LIGHT OUTPUT FOR RGBW MINI LINEAR 24 VDC

16.1 IN. / 410 MM																				
Beam Angles	15x15°					25x25°					35x35°					50x50°				
Color	Red	Green	Blue	White	All	Red	Green	Blue	White	All	Red	Green	Blue	White	All	Red	Green	Blue	White	All
Lumen / Foot	129	287	94	218	700	129	286	96	687	759	141	302	100	245	773	101	225	72	169	548
Lumen / Meter	423	941	308	715	2296	425	937	314	2255	2491	463	990	329	802	2537	332	737	236	556	1797
Total Lumens	174	386	126	293	941	174	384	129	925	1021	190	406	135	329	1040	136	302	97	228	737

23.8 IN. / 605 MM																				
Beam Angles	15x15°					25x25°					35x35°					50x50°				
Color	Red	Green	Blue	White	All	Red	Green	Blue	White	All	Red	Green	Blue	White	All	Red	Green	Blue	White	All
Lumen / Foot	136	305	106	229	739	146	315	103	230	746	146	330	110	250	789	107	235	79	178	578
Lumen / Meter	447	999	348	751	2423	480	1034	338	755	2448	479	1084	362	820	2590	350	772	258	585	1896
Total Lumens	270	605	211	455	1466	290	626	205	457	1481	290	656	219	496	1567	212	467	156	354	1147

46.9 IN. / 1190 MM																				
Beam Angles	15x15°					25x25°					35x35°					50x50°				
Color	Red	Green	Blue	White	All	Red	Green	Blue	White	All	Red	Green	Blue	White	All	Red	Green	Blue	White	All
Lumen / Foot	166	317	107	244	771	153	332	105	241	770	154	356	115	269	836	109	246	81	185	591
Lumen / Meter	484	1040	352	802	2529	500	1088	343	790	2526	506	1168	377	883	2742	359	806	265	606	1938
Total Lumens	576	1238	419	954	3009	595	1295	408	940	3006	602	1390	449	1051	3263	427	959	315	721	2306

LIGHT OUTPUT FOR RGBW MINI LINEAR 90-264 VAC

16.1 IN. / 410 MM																				
Beam Angles	15x15°					25x25°					35x35°					50x50°				
Color	Red	Green	Blue	White	All	Red	Green	Blue	White	All	Red	Green	Blue	White	All	Red	Green	Blue	White	All
Lumen / Foot	150	316	116	241	762	143	323	113	241	759	139	330	113	252	790	123	257	91	197	633
Lumen / Meter	491	1038	381	792	2499	470	1059	370	792	2491	457	1083	370	828	2593	404	842	299	646	2078
Total Lumens	202	426	156	325	1025	193	434	152	325	1021	188	444	152	339	1063	166	345	122	265	852

23.8 IN. / 605 MM																				
Beam Angles	15x15°					25x25°					35x35°					50x50°				
Color	Red	Green	Blue	White	All	Red	Green	Blue	White	All	Red	Green	Blue	White	All	Red	Green	Blue	White	All
Lumen / Foot	156	329	121	251	791	149	335	117	251	788	145	343	117	262	821	128	266	95	204	658
Lumen / Meter	510	1078	396	822	2595	488	1099	384	822	2586	475	1124	385	860	2692	419	874	310	670	2158
Total Lumens	309	652	239	497	1570	295	665	232	497	1565	287	680	233	520	1629	254	529	188	406	1305

46.9 IN. / 1190 MM																				
Beam Angles	15x15°					25x25°					35x35°					50x50°				
Color	Red	Green	Blue	White	All	Red	Green	Blue	White	All	Red	Green	Blue	White	All	Red	Green	Blue	White	All
Lumen / Foot	166	352	129	268	847	159	359	125	268	844	155	367	126	280	878	137	285	101	219	704
Lumen / Meter	546	1154	424	880	2777	523	1176	411	880	2768	508	1203	412	920	2882	449	935	332	718	2309
Total Lumens	650	1373	504	1047	3305	622	1400	489	1047	3294	605	1432	490	1095	3429	534	1113	395	854	2748

Acolyte does not warrant or represent that the information is free from errors or omission. The information may change without notice and Acolyte is not in any way liable for the accuracy of any information printed and stored or in any way interpreted or used.

DIMENSIONS

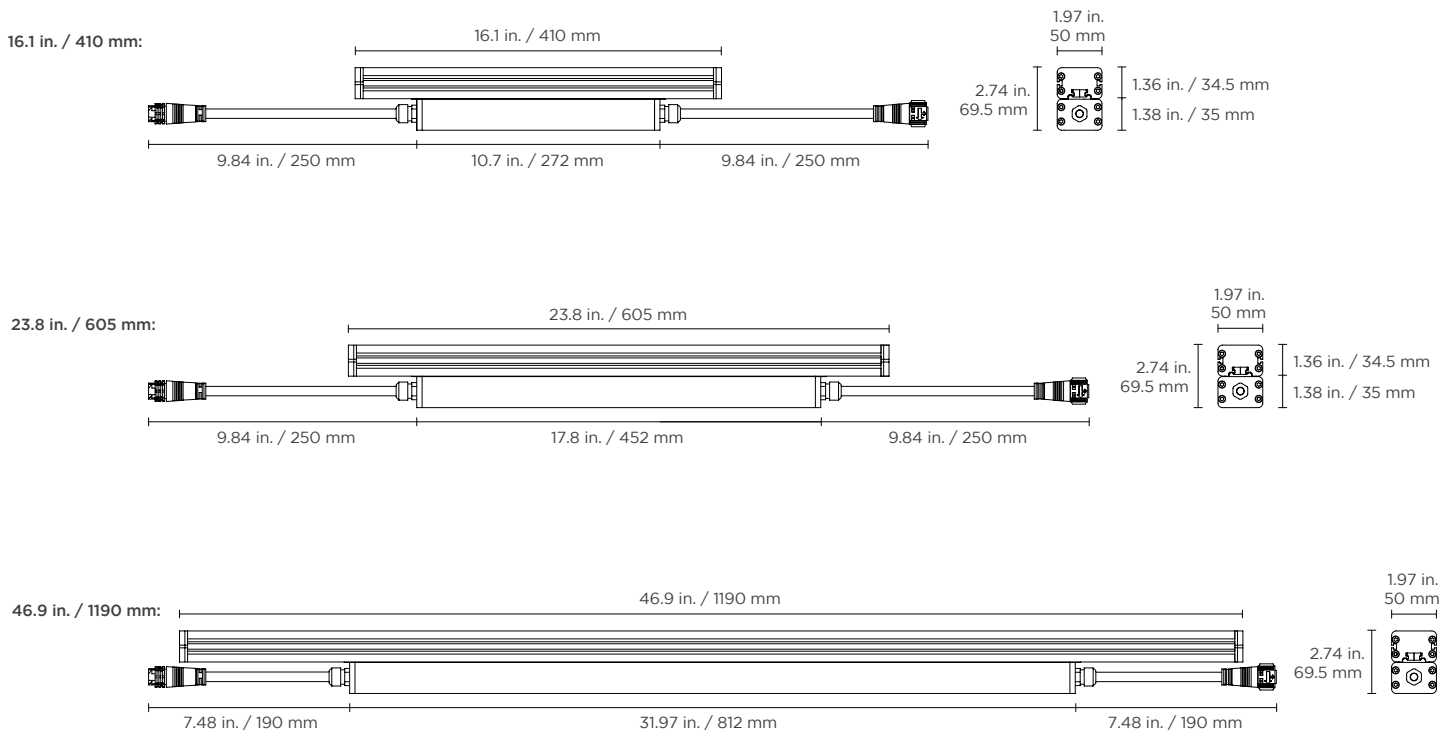

MOUNTING HARDWARE

Large Tiltable Stand
(included hardware)

For adjustable mounting angles from 0-180°
 Part Number: TSL

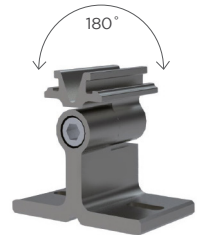
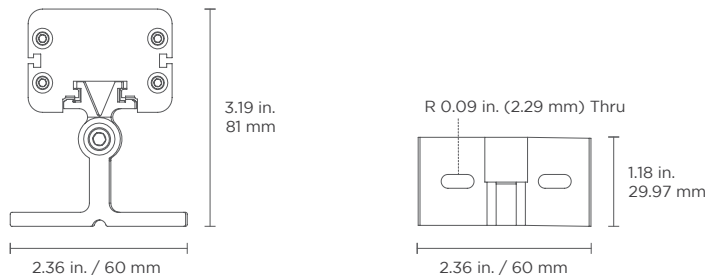

Mounting Arms

(optional hardware)

Adjustable mounts (in 2 sizes) help set desired angle and distance from lighting surface

Small Mounting Arm Part Number: ARMORMNT0609
 Large Mounting Arm Part Number: ARMORMNT1422

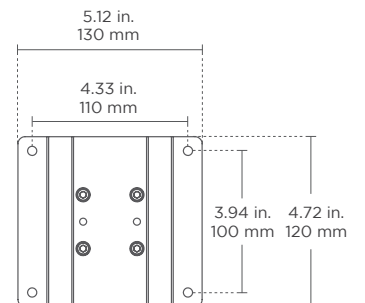
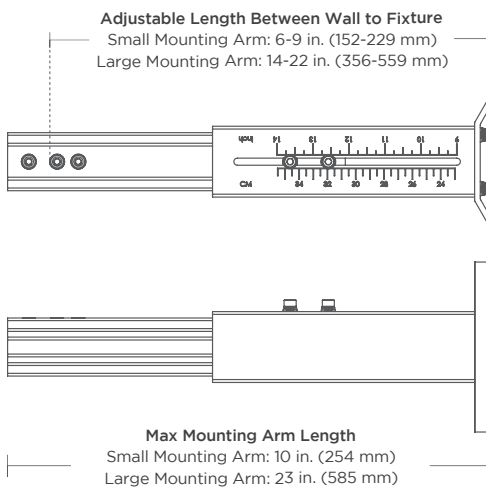
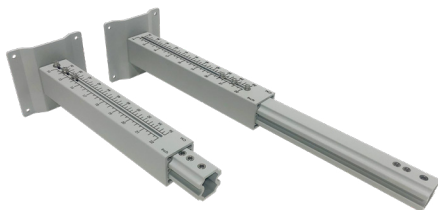

ACCESSORIES



Louwer

For glare reduction
Note: This will affect beam angle

Part Number:
MINILOUVRGBW410 (410 mm)
MINILOUVRGBW605 (605 mm)
MINILOUVRGBW1190 (1190 mm)

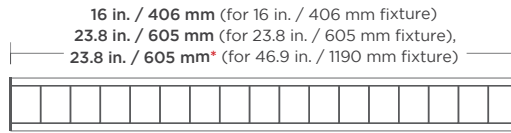

Not recommended for exterior applications

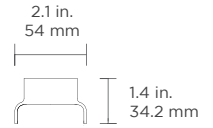

Side View



Asymmetric Louwer

For glare reduction
Note: This will affect beam angle

Part Number:
MINIALOUVRGBW410 (410 mm)
MINIALOUVRGBW605 (605 mm)
MINIALOUVRGBW1190 (1190 mm)

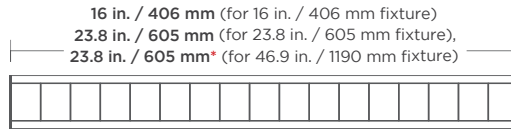

Not recommended for exterior applications

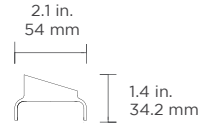

Side View



Glare Shield

To reduce glare or redirect light

Part Number:
MINISHLD410 (410 mm)
MINISHLD605 (605 mm)
MINISHLD1190 (1190 mm)

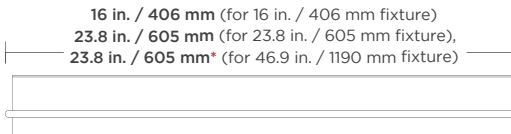

Adds 2 in./50.8 mm to the height of the fixture

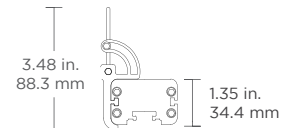

Side View

24 VDC MODELS

2 Pin Female Cable To Bare Wire
To bare wire for incoming power



Part Number:
MINICBLFB300 (300 mm)
MINICBLFB500 (500 mm)
MINICBLFB1000 (1000 mm)
MINICBLFB2000 (2000 mm)

2 Pin Male To Female Jumper Cable
To connect 2 pin male connector to 2 pin female connector



Part Number:
MINIJUMPMF1000 (1000 mm)
MINIJUMPMF2000 (2000 mm)

Power Connector End Cap

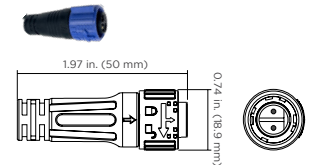

Part Number:
MINIDC-CAP2

3 Pin Female To Bare Wire DMX Input Cable
To bare wire for DMX controller



Part Number:
MINIDMXFB500 (500 mm)

3 Pin Male To 3 Pin Female DMX Jumper Cable
To connect 3 pin male connector to 3 pin female connector for DMX data



Part Number:
MINIDMXMF1000 (1000 mm)
MINIDMXMF2000 (2000 mm)

DMX Connector End Cap

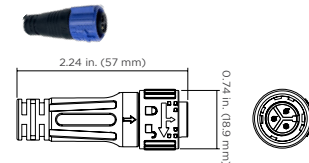

Part Number:
MINIDC-CAP3

90-264 VAC MODELS

6 Pin Cable with Female Connector to Bare Wire (Power)
To bare wire for incoming power
Lengths: 78.74 in. (2000 mm) and 19.7 ft (6000 mm)



Part Number:
MINICBLFB6PIN2000 (6.6 ft / 2000 mm)
MINICBLFB6PIN6000 (19.7 ft / 6000 mm)

6 Pin Male To Female Jumper Cable
To connect 6 pin male connector to 6 pin female connector
Lengths: 39.4 in. (1000 mm) and 78.7 in. (2000 mm)
(Consult factory for custom length)



Part Number:
MINIJUMP6PINMK1000 (3.3 ft / 1000 mm)
MINIJUMP6PINMK2000 (6.6 ft / 2000 mm)

End Cap

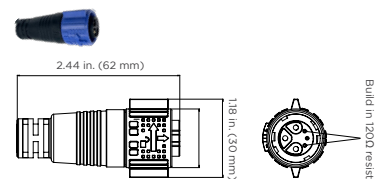

Part Number:
MINIAC-CAPRGBW

CONNECTION / CONNECTORS - RGBW MINI LINEAR 24 VDC

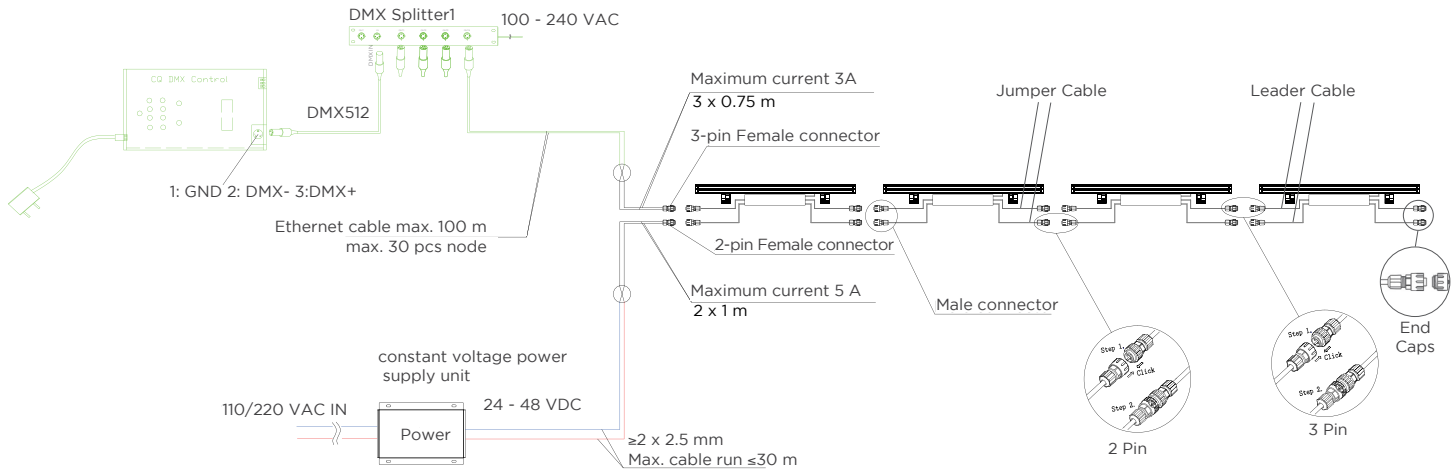

CONNECTION / CONNECTORS - RGBW MINI LINEAR 90-264 VAC

BASIC DMX WIRING

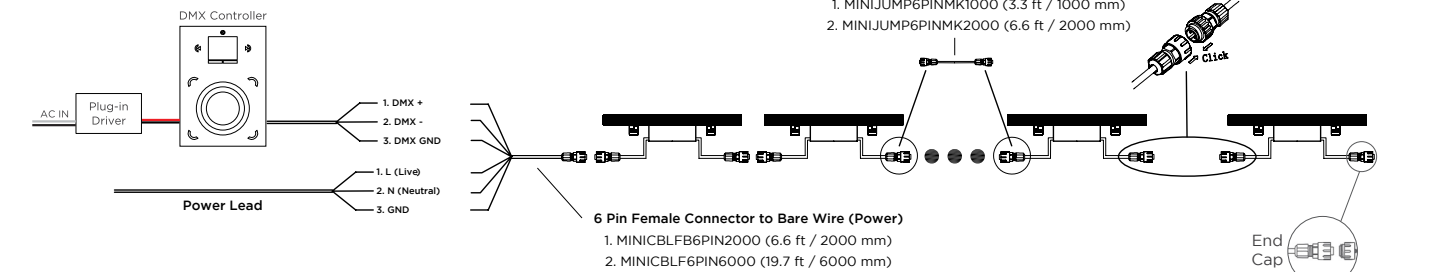

ADVANCED DMX WIRING

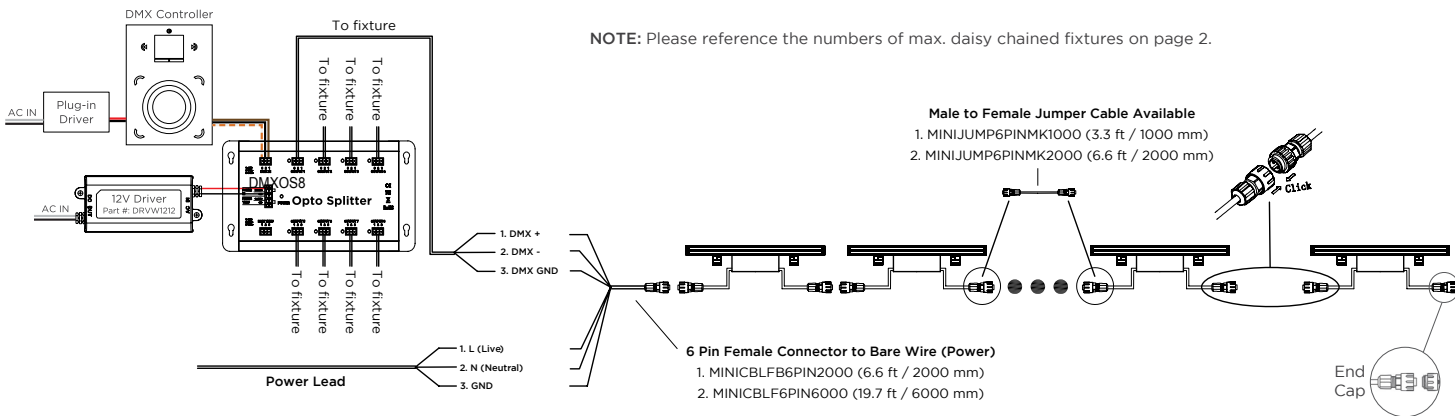

6-PIN CONNECTOR AND WIRE SPECS

Cable	Function	Pin ID	Wire Size	Wire Color (US)
Power Lead in / Power Extension	L (Line)	1	16AWG	Black
	N (Neutral)	2	16AWG	White
	GND (Ground)	3	16AWG	Green
DMX	DMX +	4	22AWG	Purple
	DMX -	5	22AWG	Gray
	DMX GND	6	22AWG	Yellow

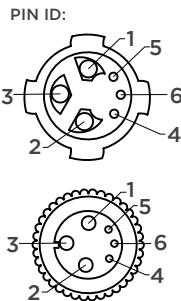

6-Pin Connector is used for the following cables:

1. Fixture in/out
2. MINIJUMP6PINMK1000
3. MINIJUMP6PINMK2000
4. MINICBLFB6PIN2000
5. MINICBLFB6PIN6000

Notes:

1. The top wiring diagram shows only typical connections. Actual wiring depends on the site configuration and installation.
2. The wire connection method shall be determined by local electrical codes and regulations. Wire nuts or screw terminal blocks are recommended for wire connection.
3. Actual number of wall washer can be connected may vary according to cable lengths and signal source.
4. Shield signal cables are recommended for signal protection.