

### ARMOR SERIES | RGBW MINI EXTERIOR LINEAR FIXTURES

Armor Series RGBW Mini Linear fixtures offer a small, sleek anodized aluminum profile with three premium optics options designed for exterior applications. Powerful RGBW LEDs let you blend and change colors for wall washing and grazing effects. Create specific hues for holidays and events or design lighting with signature corporate colors. Five standard lengths allow mixing and matching as needed to fit any project. Choose the mounting style suitable for your design, from tilting stands for focused beam angles in tight spaces to sturdy mounting arms for rock-solid light. The Armor Series RGBW Mini Linear comes with a three-year warranty.



### GEL-FLUSH™ TECHNOLOGY

The Armor Series RGBW Mini Linear fixture is manufactured with GelFlush™ Technology. This proprietary innovation uses a special Dow Corning sealant to protect your lighting from the elements. With Acolyte's Armor Series, there's no leaking and no condensation -- just clear, unobstructed beams of light!

### Applications:

Commercial      Museums  
 Entertainment      Public Spaces



**IP66**

### ORDERING GUIDE

Category	Length	Color	FWHM Beam Angle
<b>MINI</b>		<b>RGBW65</b>	
<b>MINI - Armor RGBW Mini</b>	<b>12</b> - 12.3 in. / 313 mm (14 W)	<b>RGBW65 - RGBW (6500K)</b>	<b>15</b> - 15x15°
	<b>0.5</b> - 19.7 in. / 500 mm (24 W)		<b>25</b> - 25x25°
	<b>24</b> - 23.8 in. / 605 mm (30 W)		<b>35</b> - 35x35°
	<b>1.0</b> - 39.4 in. / 1000 mm (48 W)		
	<b>47</b> - 46.9 in. / 1190 mm (60 W)		

### INCLUDED ACCESSORIES:

- 1.) Large Tilttable Stand  
TSL

### OPTIONAL ACCESSORIES:

- 1.) Armor Series Mounting Arms:  
Small: ARMORMNT0609  
Large: ARMORMNT1422

- 2.) Glare Shield:  
MINISHLD313 (313 mm)  
MINISHLD500 (500 mm)  
MINISHLD605 (605 mm)  
MINISHLD1000 (1000 mm)  
MINISHLD1190 (1190 mm)

- 3.) 2 Pin Female Cable to Bare Wire:  
MINICBLFB300 (300 mm)  
MINICBLFB500 (500 mm)  
MINICBLFB1000 (1000 mm)  
MINICBLFB2000 (2000 mm)

- 4.) 2 Pin Male to 2 Pin Female Jumper Cable:  
MINIJUMPMF1000 (1000 mm)  
MINIJUMPMF2000 (2000 mm)

- 5.) 3 Pin Female to Bare Wire DMX Cable:  
MINIDMXFB500 (500 mm)

- 6.) 3 Pin Male to 3 Pin Female DMX Jumper Cable:  
MINIDMXMF1000 (1000 mm)  
MINIDMXMF2000 (2000 mm)

### AVAILABLE COLORS



RGBW+6500K

### AVAILABLE BEAM ANGLES

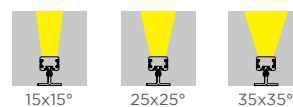

SPECIFICATIONS / DIMENSIONS / LUMEN DATA

Operating Voltage	24 VDC				
Length	12.3 in. / 313 mm	19.7 in. / 500 mm	23.8 in. / 605 mm	39.4 in. / 1000 mm	46.9 in. / 1190 mm
Power Consumption	14 W	24 W	30 W	48 W	60 W
LEDs per Fixture	8 LEDs	12 LEDs	15 LEDs	24 LEDs	30 LEDs
Amperage	0.58 A	1 A	1.25 A	2 A	2.5 A
Color / Temperature	RGBW+6500K				
LED Beam Angle	15x15°, 25x25°, 35x35°				
Max Daisy Chained Power	8 fixtures	5 fixtures	4 fixtures	2 fixtures	2 fixtures
Max Daisy Chained DMX	32 fixtures				
Control System	DMX				
LED Binning (SDCM)	3-Step MacAdam ellipse (White Channel Only)				
Ambient Temperature	-40 – 122 °F (-40 – 50 °C)				
Housing / Lens Materials	Housing: Extruded Aluminium / Lens: Clear UV Protected PMMA Cover: Tempered Glass End Caps: Extruded Aluminium / Brackets: Extruded Aluminium Housing, bracket, end cap material – 6063 high density aluminum alloy				
Connector	2 pin power connector / 3 pin DMX signal connector				
Cable Length	11.81 in. / 300 mm				
Protection Rating	IP66				
Mounting Options	Large Tilttable Stand (180° adjustable), Mounting Arms (available in 2 different sizes)				
Impact Rating	IK08				
Lamp Life	50,000 hours				
Certifications	CE, ETL / Luminaires - UL 1598, 3rd Ed., issued September 17, 2008, Rev. October 17, 2012 / Luminaires - CSA C22.2 No.250.0-08, 3rd Ed., issued September 17, 2008, Rev. October 17, 2012 (R2013)				
Fixture Color Finish	Anodized silver				

LIGHT OUTPUT FOR 12.3 IN. / 313 MM

LED Beam Angles	15x15°					25x25°					35x35°				
	Red	Green	Blue	White	All	Red	Green	Blue	White	All	Red	Green	Blue	White	All
Lumen Output / Foot	155.3	230.9	39	277	734.7	144.2	248	37.2	271.8	735.3	153.8	227.6	39.3	247.6	621.8
Total Lumens	159.1	236.7	40	284	753.1	147.8	254.2	38.1	278.6	753.7	157.6	233.2	40.2	253.8	637.4

LIGHT OUTPUT FOR 19.7 IN. / 500 MM

LED Beam Angles	15x15°					25x25°					35x35°				
	Red	Green	Blue	White	All	Red	Green	Blue	White	All	Red	Green	Blue	White	All
Lumen Output / Foot	155.3	230.9	39	277	734.7	144.2	248	37.2	271.8	735.3	153.8	227.6	39.3	247.6	621.8
Total Lumens	254.9	379.1	64	454.8	1206.2	236.7	407.1	61	446.2	1207.2	157.6	373.6	77.9	253.8	1020.8

LIGHT OUTPUT FOR 23.8 IN. / 605 MM

LED Beam Angles	15x15°					25x25°					35x35°				
	Red	Green	Blue	White	All	Red	Green	Blue	White	All	Red	Green	Blue	White	All
Lumen Output / Foot	155.3	230.9	39	277	734.7	144.2	248	37.2	271.8	735.3	153.8	227.6	39.3	247.6	621.8
Total Lumens	307.9	458.0	77.4	549.5	1457.2	285.9	491.8	73.7	539.1	1458.4	305	451.3	77.9	491.1	1233.3

LIGHT OUTPUT FOR 39.4 IN. / 1000 MM

LED Beam Angles	15x15°					25x25°					35x35°				
	Red	Green	Blue	White	All	Red	Green	Blue	White	All	Red	Green	Blue	White	All
Lumen Output / Foot	155.3	230.9	39	277	734.7	144.2	248	37.2	271.8	735.3	153.8	227.6	39.3	247.6	621.8
Total Lumens	509.8	758.1	128.1	909.6	2412.3	473.3	814.2	122.1	892.4	2414.3	505	747.1	128.9	813	2041.7

LIGHT OUTPUT FOR 47 IN. / 1190 MM

LED Beam Angles	15x15°					25x25°					35x35°				
	Red	Green	Blue	White	All	Red	Green	Blue	White	All	Red	Green	Blue	White	All
Lumen Output / Foot	155.3	230.9	39	277	734.7	144.2	248	37.2	271.8	735.3	153.8	227.6	39.3	247.6	621.8
Total Lumens	610.7	908.2	153.4	1089.7	2889.9	567	975.4	146.3	1069.1	2892.3	604.9	895	154.4	973.9	2445.8

Acolyte does not warrant or represent that the information is free from errors or omission. The information may change without notice and Acolyte is not in any way liable for the accuracy of any information printed and stored or in any way interpreted or used.

DIMENSIONS / MOUNTING HARDWARE

DIMENSION DRAWINGS

12.3 in. / 313 mm:

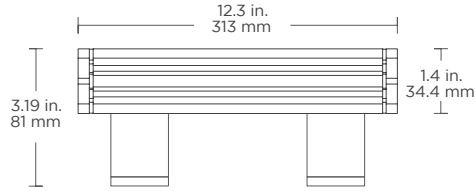

End view for all sizes:

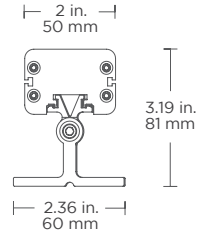

19.7 in. / 500 mm:

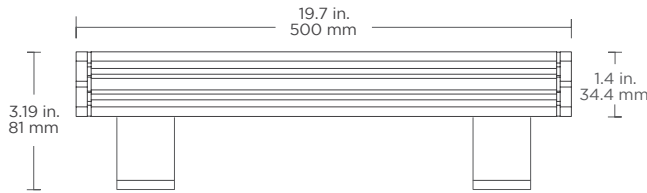

23.8 in. / 605 mm:

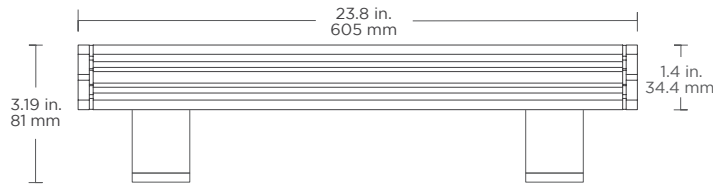

39.4 in. / 1000 mm:

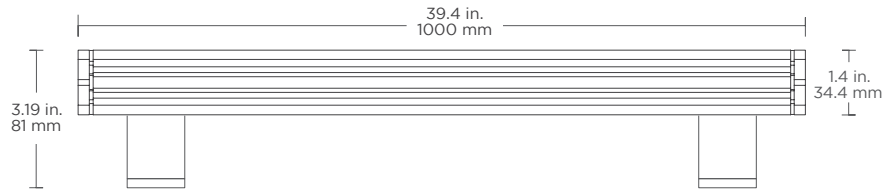

46.9 in. / 1190 mm:

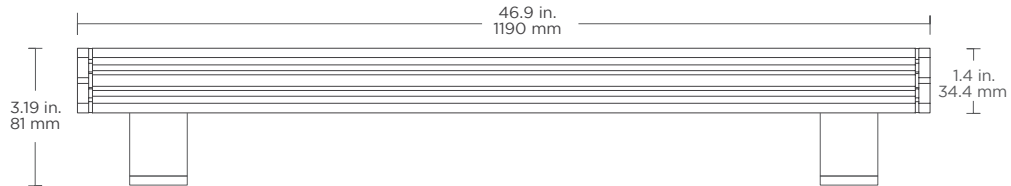

MOUNTING HARDWARE

Large Tilttable Stand  
For adjustable mounting angles  
up to 180°

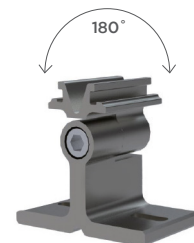
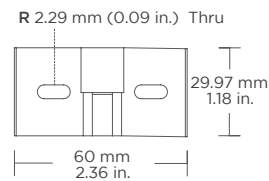
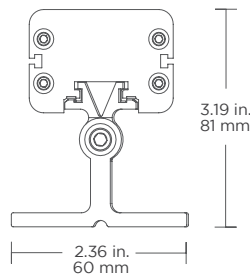

**MOUNTING HARDWARE / ACCESSORIES**

**MOUNTING HARDWARE**

**Mounting Arms**

Small Mounting Arm Part Number: ARMORMNT0609  
Large Mounting Arm Part Number: ARMORMNT1422

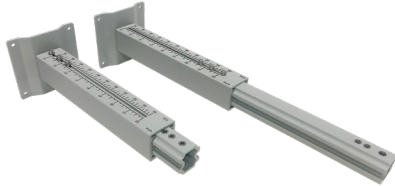

**Armor Series Mounting Arm**

Adjustable mounts (in 3 sizes) help set desired angle and distance from lighting surface

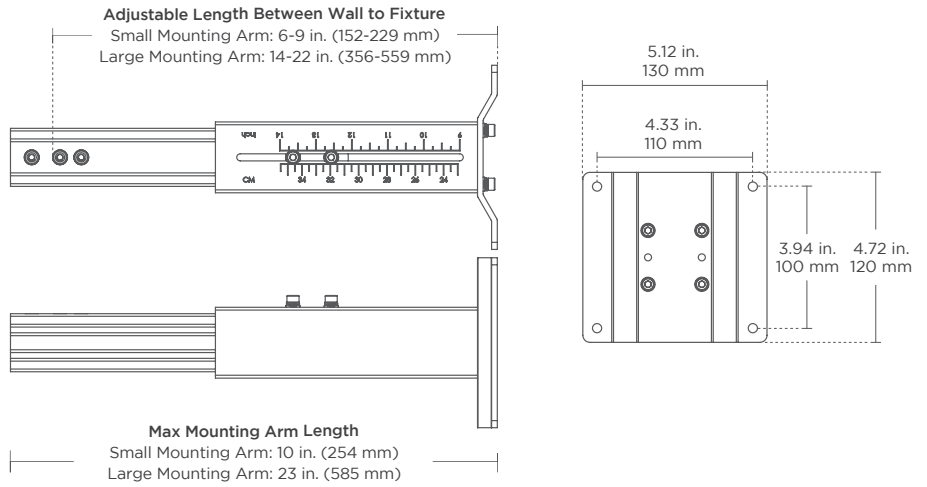

**ACCESSORIES**



**Glare Shield**

Part Number: MINISHLD

To reduce glare or redirect light

- MINISHLD313 (313 mm)
- MINISHLD500 (500 mm)
- MINISHLD605 (605 mm)
- MINISHLD1000 (1000 mm)
- MINISHLD1190 (1190 mm)

- 12.3 in. / 313 mm (for 12.3 in. / 313 mm fixture),
- 19.7 in. / 500 mm (for 19.7 in. / 500 mm fixture),
- 23.8 in. / 605 mm (for 23.8 in. / 605 mm fixture),
- 39.4 in. / 1000 mm (for 39.4 in. / 1000 mm fixture),
- 46.9 in. / 1190 mm (for 46.9 in. / 1190 mm fixture)

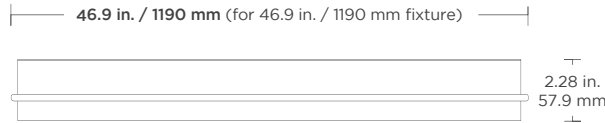

Adds 2.0 in. / 50.8 mm to the height of the fixture

FRONT VIEW

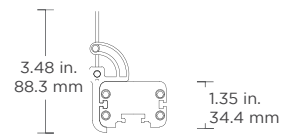

SIDE VIEW



**2 Pin Female Cable To Bare Wire**

Part Number: MINICBLFB

To bare wire for incoming power

- MINICBLFB300 (300 mm)
- MINICBLFB500 (500 mm)
- MINICBLFB1000 (1000 mm)
- MINICBLFB2000 (2000 mm)



**2 Pin Male To Female Jumper Cable**

Part Number: MINIJUMPMF

To connect 2 pin male connector to 2 pin female connector

- MINIJUMPMF1000 (1000 mm)
- MINIJUMPMF2000 (2000 mm)



**3 Pin Female To Bare Wire DMX Input Cable**

Part Number: MINIDMXFB

To bare wire for DMX controller

- MINIDMXFB500 (500 mm)



**3 Pin Male To 3 Pin Female DMX Jumper Cable**

Part Number: MINIDMXMF

To connect 3 pin male connector to 3 pin female connector for DMX data

- MINIDMXMF1000 (1000 mm)
- MINIDMXMF2000 (2000 mm)

CONNECTION / CONNECTORS

DMX:

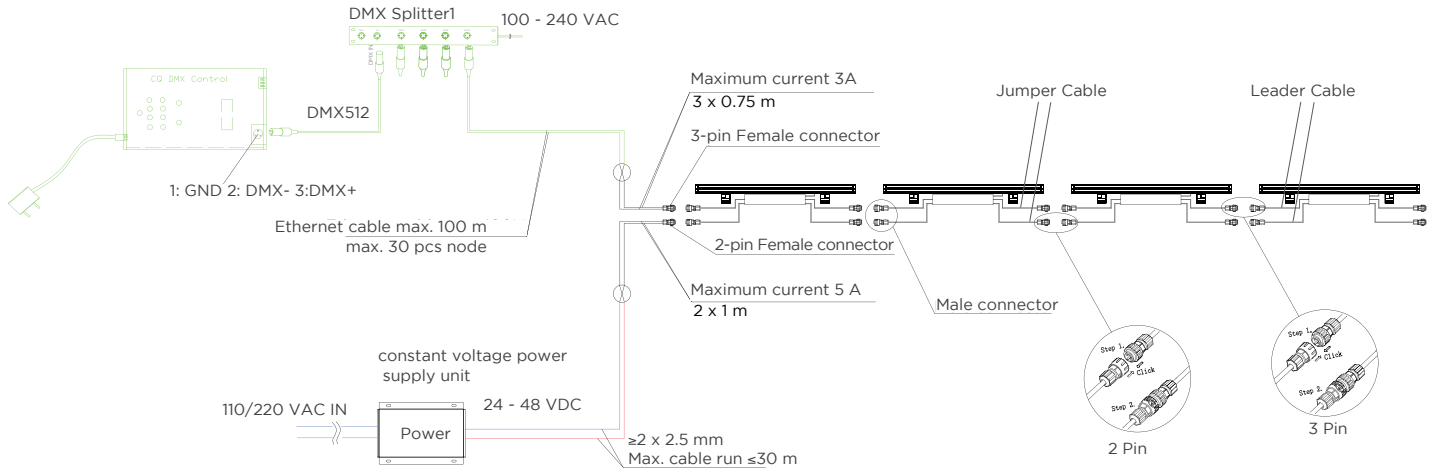

REV.27NOV2024

**GLOBAL HQ**

320 Murray Hill Pkwy  
East Rutherford, NJ 07073  
U.S.  
T: (+1) 212 629 6830  
E: Sales-US@GENLEDBrands.com

**EUROPEAN HQ**

Hogeweyselaan 119  
1382 JK Weesp  
Netherlands  
T: (+31) 346 235 000  
E: SalesEurope@GENLEDBrands.com

**MEINA HQ**

PO Box 371378, #823, Building 4EA  
Dubai Airport Free Zone, Dubai, UAE  
T: (+971) 4 701 7901  
E: SalesMEINA@genlebrands.com

**ASIA-PACIFIC HQ**

Room 402, Building D  
ShenShi Tongchuang Science and Technology Park  
No. 16 Hongyin Road  
Xingqiang Community, Xinhua Street  
Guangming District, Shenzhen, China 518107  
Sales: (+86) 139 1836 3905  
Office: (+86) 755 8529 0710  
E: Sales-Pacific@GENLEDBrands.com