

ARMOR SERIES | MINI LINEAR

Armor Series Mini Linear fixtures offer a small, sleek anodized aluminum profile with six premium optics options designed for exterior applications. Six brilliant CCTs (2700K-6000K) and three standard lengths allow mixing and matching as needed to fit any project. Choose from our traditional 24 VDC design or 90-264 VAC with an onboard driver! Select the mounting style suitable for your design, from tilting stands for focused beam angles in tight spaces to sturdy mounting arms for rock-solid light. Armor Series Mini Linear fixtures come with a three-year warranty.



GEL-FLUSH™ TECHNOLOGY

The Armor Series Mini Linear fixture is manufactured with GelFlush™ Technology. This proprietary innovation uses a special Dow Corning sealant to protect your lighting from the elements. With Acolyte's Armor Series, there's no leaking and no condensation – just clear, unobstructed beams of light!



ORDERING GUIDE (FOR DC MODELS)

Category	CRI	Input Voltage	Length	Color Temperature		FWHM Beam Angle		Mounting Option
MINI	80	24						
MINI - MINI Linear	80 - 80+ CRI	24 - 24 VDC	12 - 12.3 in. / 313 mm (9 W) 24 - 23.8 in. / 605 mm (18 W) 47 - 46.9 in. / 1190 mm (36 W)	27 - 2700K 30 - 3000K 35 - 3500K	40 - 4000K 50 - 5000K 60 - 6000K	10 - 10x10° 15 - 15x15° 25 - 25x25°	35 - 35x35° 50 - 50x50° 10x60 - 10x60°	SI - Snap-In TS - Tiltable Stand TSL - Large Tilttable Stand

ORDERING GUIDE (FOR AC MODELS)

Category	CRI	Input Voltage	Length	Color Temperature		FWHM Beam Angle	
MINI	80	AC					
MINI - MINI Linear	80 - 80+ CRI	AC - 90-264 VAC	12 - 12.3 in. / 313 mm (9 W) 24 - 23.8 in. / 605 mm (18 W) 47 - 46.9 in. / 1190 mm (36 W)	27 - 2700K 30 - 3000K 35 - 3500K	40 - 4000K 50 - 5000K 60 - 6000K	10 - 10x10° 15 - 15x15° 25 - 25x25°	35 - 35x35° 50 - 50x50° 10x60 - 10x60°

OPTIONAL ACCESSORIES:

- | | | | | | | |
|--|--|---------------------------|--|---------------------------|--|--|
| <p>1.) Armor Series Mounting Arms:
Small: ARMORMNT0609
Large: ARMORMNT1422</p> <p>2.) Symmetric Louver:
MINILOUV313 (313 mm)
MINILOUV605 (605 mm)
MINILOUV1190 (1190 mm)</p> | <p>3.) Asymmetric Louver:
MINIALOUV313 (313 mm)
MINIALOUV605 (605 mm)
MINIALOUV1190 (1190 mm)</p> <p>4.) Glare Shield:
MINISHL313 (313 mm)
MINISHL605 (605 mm)
MINISHL1190 (1190 mm)</p> | <p>For DC models only</p> | <p>5.) 2 Pin Male to Female Jumper Cable:
MINIJUMPMF1000 (1000 mm)
MINIJUMPMF2000 (2000 mm)</p> <p>6.) 2 Pin Female Cable to Bare Wire:
MINICLFB300 (300 mm)
MINICLFB500 (500 mm)
MINICLFB1000 (1000 mm)
MINICLFB2000 (2000 mm)</p> <p>7.) End Cap:
MINIDC-CAP2</p> | <p>For AC models only</p> | <p>8.) 6 Pin Male to Female Jumper Cable:
MINIJUMP6PINMK1000 (1000 mm)
MINIJUMP6PINMK2000 (2000 mm)</p> <p>9.) 6 Pin Cable with Female Connector to Bare Wire (Power):
MINICLFB6PIN2000 (2000 mm)
MINICLFB6PIN6000 (6000 mm)</p> | <p>10.) T-Connector (Fixture Chain Splitter)
MINICBLTJOINT6PIN</p> <p>11.) End Cap:
MINIAC-CAPSW</p> |
|--|--|---------------------------|--|---------------------------|--|--|

DRIVERS (FOR DC MODELS):

0-10V/ELV/MLV 3-IN-1	DIMMABLE ELECTRONIC DRIVERS	NON-DIMMING ELECTRONIC DRIVERS
----------------------	-----------------------------	--------------------------------

<p>60W, 96W, 288W 0-10V/ELV/MLV 3-in-1 Dimmable Drivers</p> <p>Part No.:</p> <ul style="list-style-type: none"> • DRVW2460TRI010 (60 W) • DRVW2496TRI010 (96 W) • DRVW24288TRI010 (288 W) 	<p>60W Dimmable Drivers</p> <p>Part No.:</p> <ul style="list-style-type: none"> • DRV2460ELV 	<p>60W, 96W Non-Dimming Compact Drivers</p> <p>Part No.:</p> <ul style="list-style-type: none"> • DRV2460C (60 W) • DRV2496C (96 W)
---	--	--

ATHENA WIRELESS COMPATIBLE	CASAMBI COMPATIBLE DRIVERS	DIMMABLE DALI-2 DRIVERS	DIMMABLE DALI-2 DRIVERS
----------------------------	----------------------------	-------------------------	-------------------------

<p>94W Athena Wireless Compatible Drivers</p> <p>Part No.:</p> <ul style="list-style-type: none"> • DRVW2494ATH1CH (1 channel) • DRVW2494ATH2CH (2 channel) 	<p>100W & 200W Casambi Compatible 4 Channel Drivers</p> <p>Part No.:</p> <ul style="list-style-type: none"> • DRVW24100CAS4CH (100 W) • DRVW24200CAS4CH (200 W) 	<p>96W Dimmable DALI-2 DT6 D4I & DT8 D4I Drivers</p> <p>Part No.:</p> <ul style="list-style-type: none"> • DRVW2496DALI1CH (1 channel) • DRVW2496DALI2CH (2 channel) 	<p>75W, 150W, 240W DALI-2 Dimmable Drivers</p> <p>Part No.:</p> <ul style="list-style-type: none"> • DRVW2475DALI1CH (75 W, 1 channel) • DRVW24150DALI1CH (150 W, 1 channel) • DRVW24240DALI1CH (240 W, 1 channel) • DRV24150DALI2CH (150 W, 2 channels) • DRV24150DALI4CH (150 W, 4 channels)
--	--	---	--

AVAILABLE COLOR TEMPERATURES

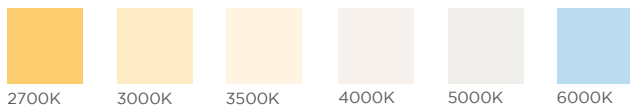

AVAILABLE BEAM ANGLES

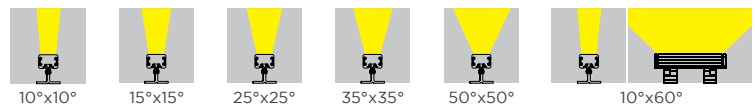

SPECIFICATIONS

Operating Voltage	24 VDC			90-264 VAC		
Color Temperature	2700K, 3000K, 3500K 4000K, 5000K, 6000K					
Beam Angles	10x10°, 15x15°, 25x25°, 35x35°, 50x50°, 10x60°					
Length	12.3 in. / 313 mm	23.8 in. / 605 mm	46.9 in. / 1190 mm	12.3 in. / 313 mm	23.8 in. / 605 mm	46.9 in. / 1190 mm
Power Consumption	9 W	18 W	36 W	9 W	18 W	36 W
LEDs per Fixture	9 LEDs	18 LEDs	36 LEDs	9 LEDs	18 LEDs	36 LEDs
Amperage	0.375 A	0.75 A	1.5 A	0.08 A @ 120 V 0.04 A @ 230 V	0.17 A @ 120 V 0.09 A @ 230 V	0.33 A @ 120 V 0.17 A @ 230 V
Max. Run Length	12 fixtures	6 fixtures	4 fixtures	12 fixtures @ 120 V 10 fixtures @ 230 V	12 fixtures @ 120 V 10 fixtures @ 230 V	11 fixtures @ 120 V 8 fixtures @ 230 V
Weight	1.83 lb / 0.83 kg	3.78 lb / 1.72 kg	6.18 lb / 2.81 kg	3.06 lb / 1.39 kg	6.36 lb / 2.89 kg	11.33 lb / 5.15 kg
Control System	0-10V, ELV/MLV, DALI					
CRI	80+ CRI					
LED Binning (SDCM)	3-step					
Binning Tolerance	+/- 100K					
Ambient Temperature	-40 – 122 °F (-40 – 50 °C)					
Housing / Lens Materials	Housing: Extruded Aluminium / Lens: Clear UV Protected PMMA Cover: Tempered Glass End Caps: Extruded Aluminium / Brackets: Extruded Aluminium Housing, bracket, end cap material - 6063 high density aluminum alloy					
Connector	2 pin power connector			6 Pin Combined Power and Dimming. 16 AWG Power / 22 AWG Dimming		
Cable Length	11.81 in. / 300 mm					
Protection Rating	IP67					
Impact Rating	IK07					
Mounting Options	Snap-In Clip, Tilttable Stand (140° adjustable), Large Tilttable Stand (180° adjustable), Mounting Arms (available in 2 different sizes)			Large Tilttable Stand (180° adjustable), Mounting Arms (available in 2 different sizes)		
Lifetime (L70 reported)	50,000 hours					
Certifications	CE / Luminaires - UL 1598, 3rd Ed., issued September 17, 2008, Rev. October 17, 2012 / Luminaires - CSA C22.2 No.250.0-08, 3rd Ed., issued September 17, 2008, Rev. October 17, 2012 (R2013)					
Fixture Color Finish	Anodized silver					

LIGHT OUTPUT FOR MINI LINEAR 24 VDC (at 3000K)

Length	12.3 in. / 313 mm						23.8 in. / 605 mm						46.9 in. / 1190 mm					
	10x10°	15x15°	25x25°	35x35°	50x50°	10x60°	10x10°	15x15°	25x25°	35x35°	50x50°	10x60°	10x10°	15x15°	25x25°	35x35°	50x50°	10x60°
Beam Angles	10x10°	15x15°	25x25°	35x35°	50x50°	10x60°	10x10°	15x15°	25x25°	35x35°	50x50°	10x60°	10x10°	15x15°	25x25°	35x35°	50x50°	10x60°
Lumen / Foot	843	846	846	863	857	673	913	920	939	945	924	745	944	959	985	984	970	745
Lumen / Meter	2767	2775	2776	2833	2812	2209	2997	3020	3081	3101	3033	2443	3096	3145	3230	3229	3183	2445
Total Lumens	866	869	869	887	880	691	1813	1827	1864	1876	1835	1478	3684	3743	3844	3843	3788	2909

LIGHT OUTPUT FOR MINI LINEAR 90-264 VAC (at 3000K)

Length	12.3 in. / 313 mm						23.8 in. / 605 mm						46.9 in. / 1190 mm					
	10x10°	15x15°	25x25°	35x35°	50x50°	10x60°	10x10°	15x15°	25x25°	35x35°	50x50°	10x60°	10x10°	15x15°	25x25°	35x35°	50x50°	10x60°
Beam Angles	10x10°	15x15°	25x25°	35x35°	50x50°	10x60°	10x10°	15x15°	25x25°	35x35°	50x50°	10x60°	10x10°	15x15°	25x25°	35x35°	50x50°	10x60°
Lumen / Foot	996	1059	1089	1046	1025	814	1907	2033	2082	2003	1950	1548	1017	1130	1119	1089	1058	831
Lumen / Meter	3268	3473	3572	3431	3364	2672	3152	3360	3441	3311	3223	2559	3338	3706	3672	3572	3471	2728
Total Lumens	1023	1087	1118	1074	1053	836.3	1907	2033	2082	2003	1950	1548	3972	4410	4370	4251	4130	3246

Acolyte does not warrant or represent that the information is free from errors or omission. The information may change without notice and Acolyte is not in any way liable for the accuracy of any information printed and stored or in any way interpreted or used.

DIMENSIONS

24 VDC MODELS

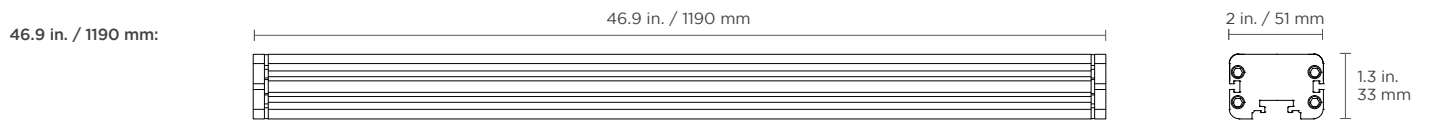
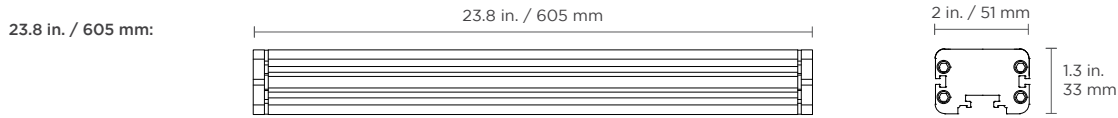
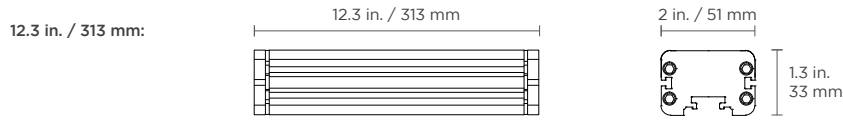

90-264 VAC MODELS

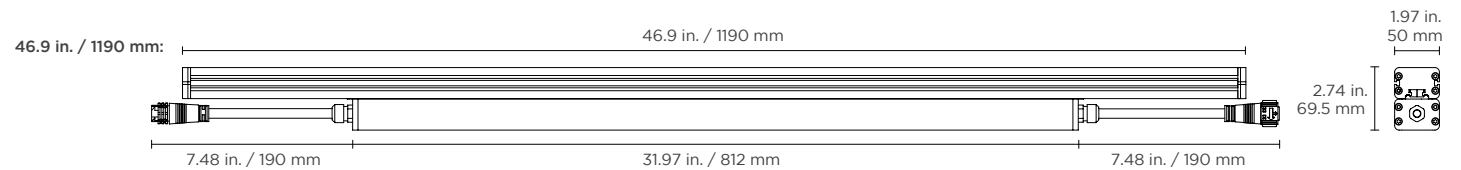
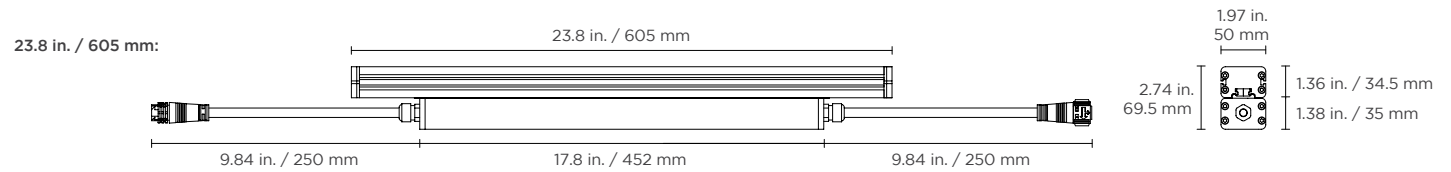
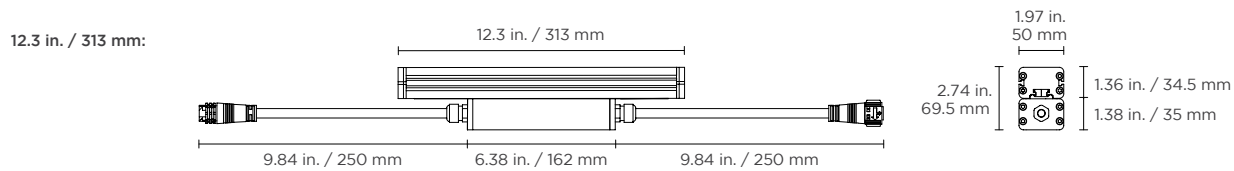

MOUNTING HARDWARE

MOUNTING HARDWARE

Ø 0.24 in. (6 mm)

Snap-In Clip (For DC models only)

For narrow installations where mounting clips need to be installed first

Part Number: SI

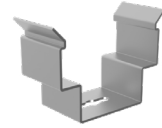
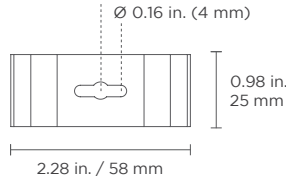
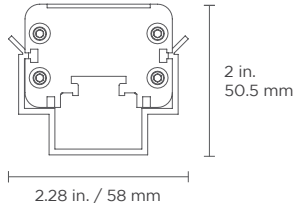

Tiltable Stand (For DC models only)

For adjustable mounting angles from 0-140°

Part Number: TS

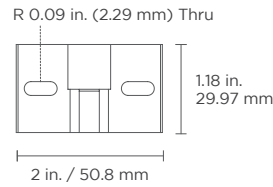
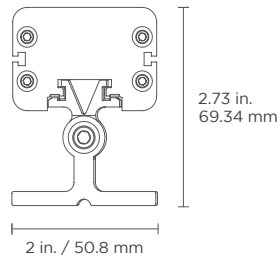

Large Tiltable Stand

For adjustable mounting angles from 0-180°

Part Number: TSL

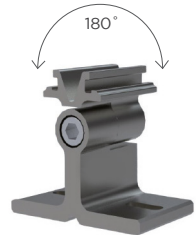
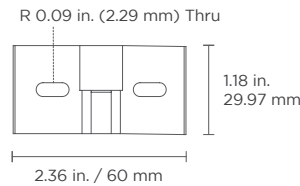
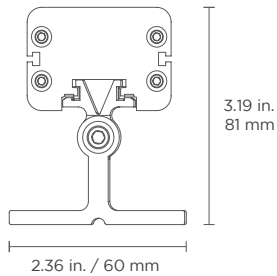

Mounting Arms

Small Mounting Arm Part Number: ARMORMNT0609
Large Mounting Arm Part Number: ARMORMNT1422

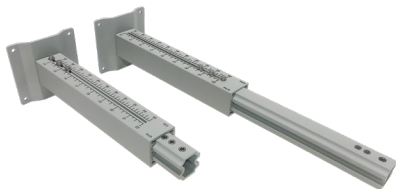

Armor Series Mounting Arm
Adjustable mounts (in 2 sizes) help set desired angle and distance from lighting surface

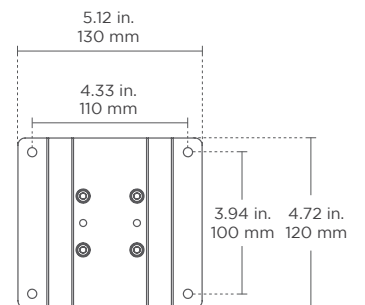
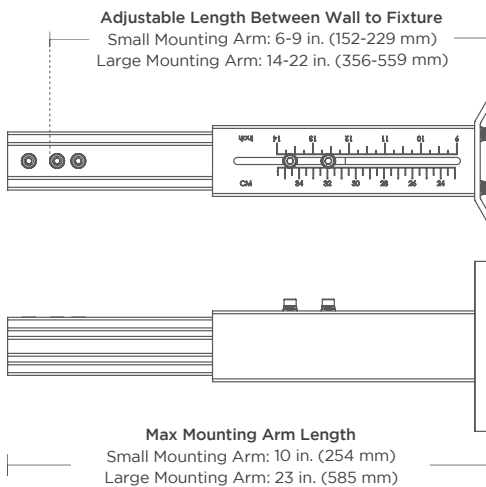

ACCESSORIES



Louver

For glare reduction
Note: This will affect beam angle
Part Number: MINILOUV

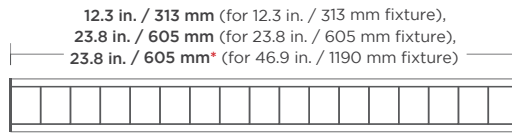

Not recommended for exterior applications
* Needs two 23.8 in. / 605 mm Louvers for 46.9 in. / 1190 mm fixture

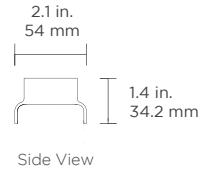

Asymmetric Louver

For glare reduction
Note: This will affect beam angle
Part Number: MINIALOUV

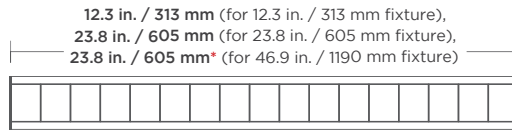

Not recommended for exterior applications
* Needs two 23.8 in. / 605 mm Asymmetric Louvers for 46.9 in. / 1190 mm fixture

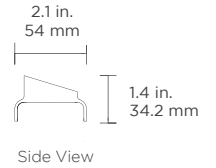

Glare Shield

To reduce glare or redirect light
Part Number: MINISHLD

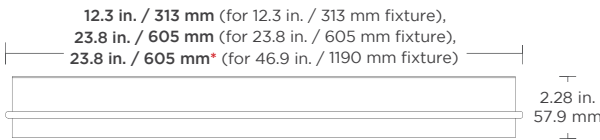

Adds 2 in./50.8 mm to the height of the fixture
* Needs two 23.8 in. / 605 mm Glare Shields for 46.9 in. / 1190 mm fixture

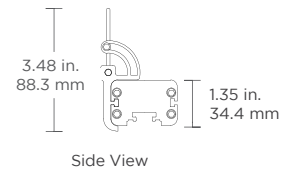

24 VDC MODELS

2 Pin Female Cable To Bare Wire
To bare wire for incoming power



Part Number: MINICBLFB

2 Pin Male To Female Jumper Cable
To connect 2 pin male connector to 2 pin female connector
Default cable length: 11.81 in. / 30 cm
(Consult factory for custom length)



Part Number: MINIJUMPMF

End Cap

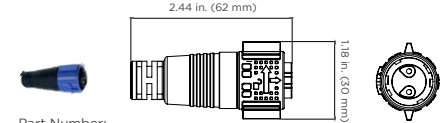

Part Number: MINICD-CAP2

90-264 VAC MODELS

6 Pin Cable with Female Connector to Bare Wire (Power)
To bare wire for incoming power
Lengths: 78.74 in. (2000 mm) and 19.7 ft (6000 mm)



Part Number:
MINICBLFB6PIN2000 (6.6 ft / 2000 mm)
MINICBLFB6PIN6000 (19.7 ft / 6000 mm)

6 Pin Male To Female Jumper Cable
To connect 6 pin male connector to 6 pin female connector
Lengths: 39.4 in. (1000 mm) and 78.7 in. (2000 mm)
(Consult factory for custom length)



Part Number:
MINIJUMP6PINMK1000 (3.3 ft / 1000 mm)
MINIJUMP6PINMK2000 (6.6 ft / 2000 mm)

T-Connector (Fixture Chain Splitter)



Part Number:
MINICBLTJOINT6PIN

End Cap

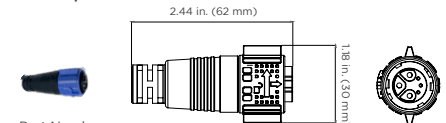

Part Number:
MINIAC-CAPSW

CONNECTION - 24 VDC MODELS

NON-DIMMING FOR CASE 1:

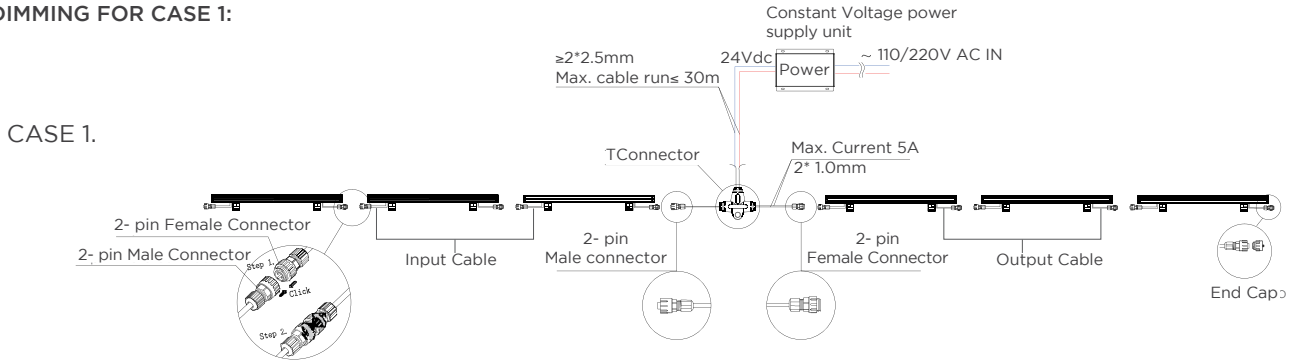

CASE 2.

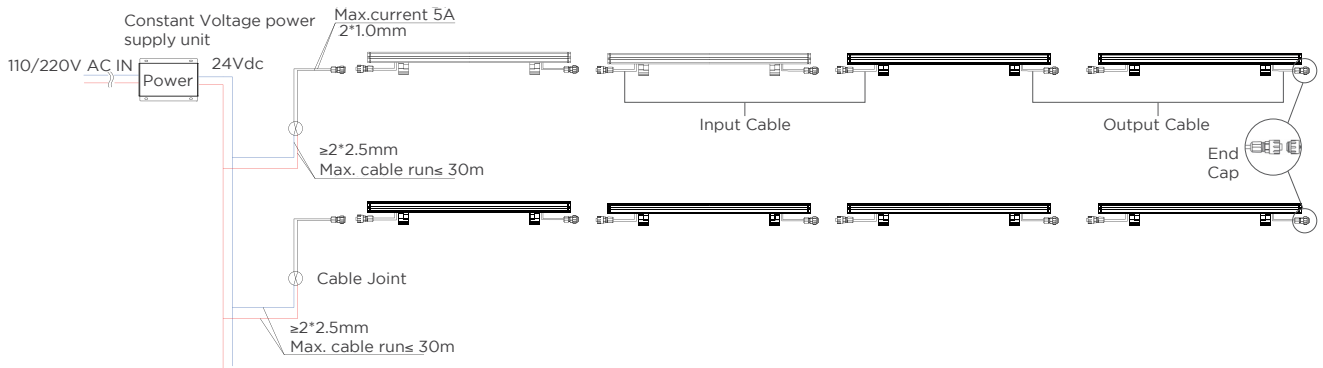

0-10V DIMMING:

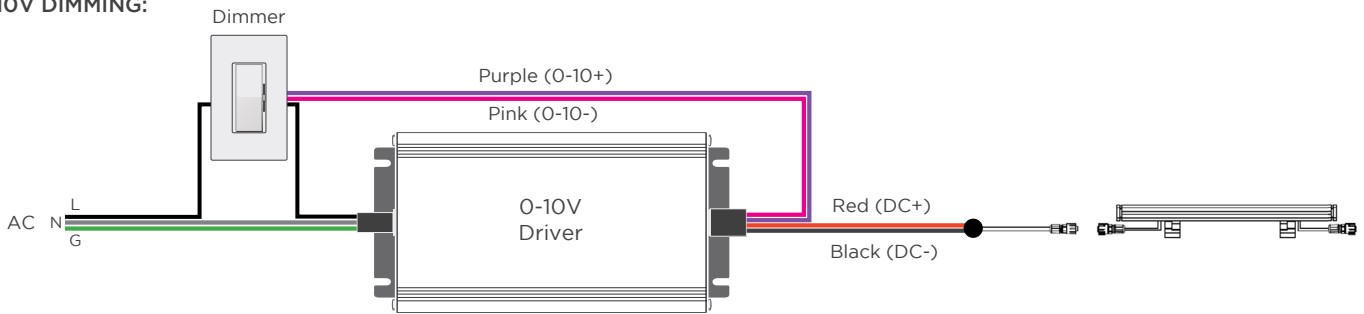

ELV/MLV DIMMING:

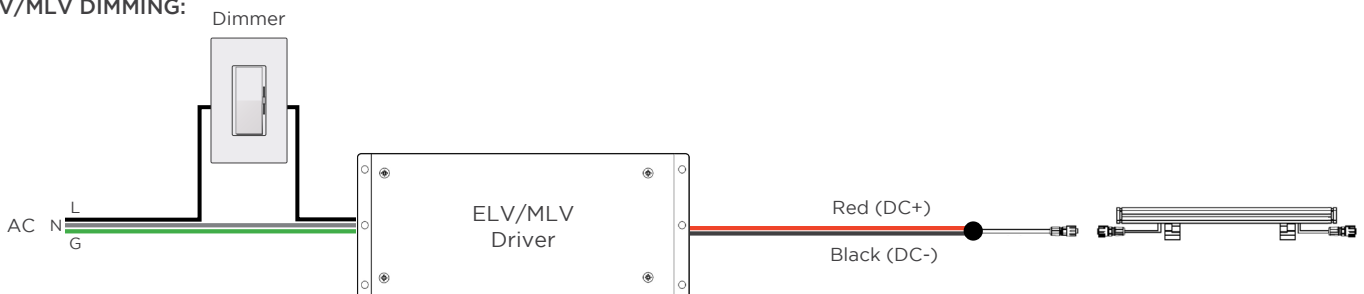

CONNECTION - 24 VDC MODELS (CONT.)

DALI DIMMING:

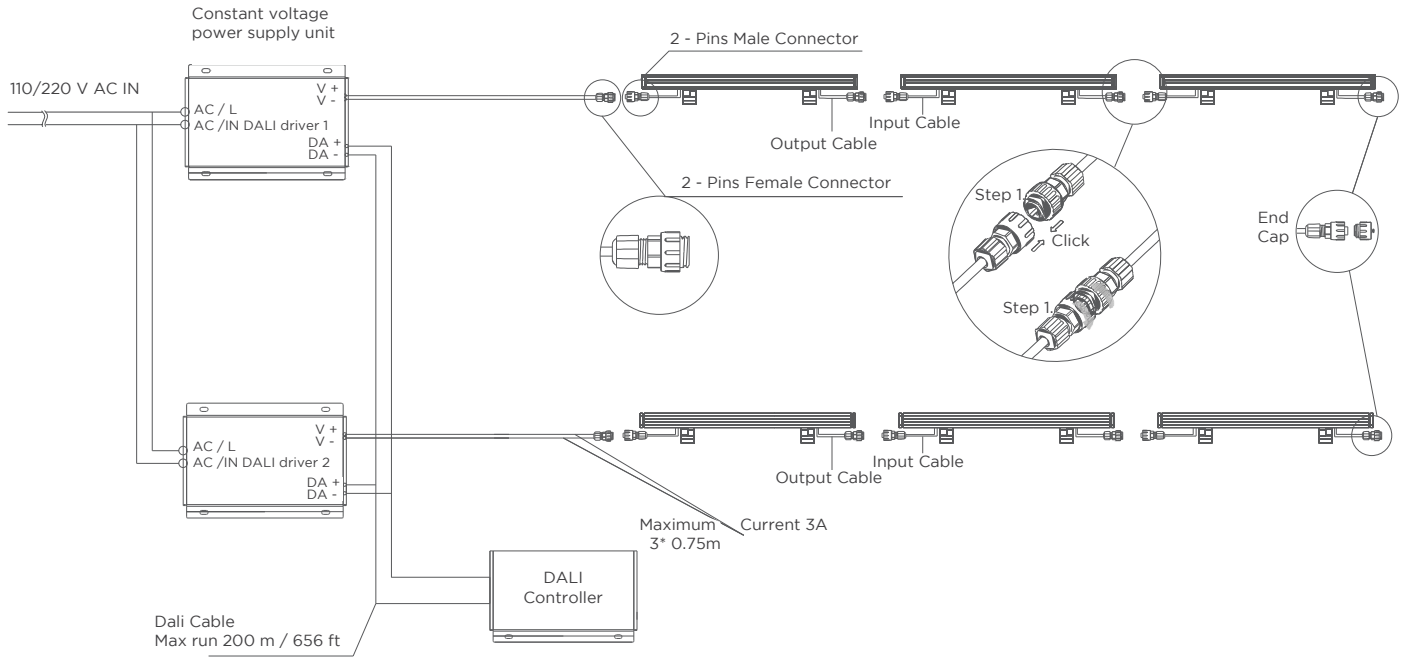

CONNECTORS:

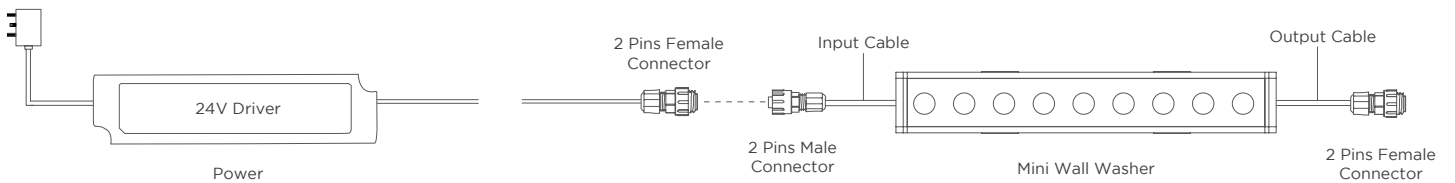

CONNECTION - 90-264 VAC MODELS

WIRING DIAGRAM

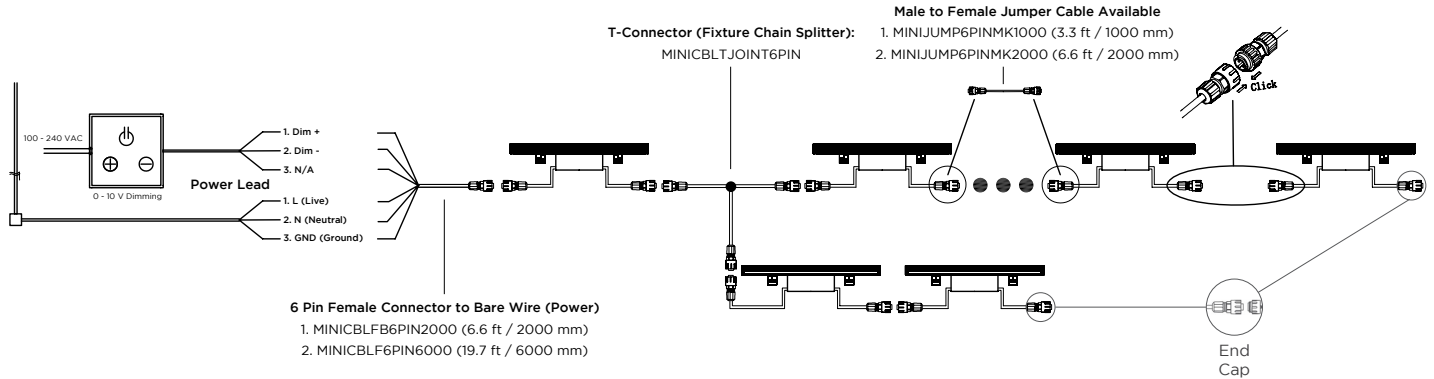

6-PIN CONNECTOR AND WIRE SPECS

Cable	Function	Pin ID	Wire Size	Wire Color (US)
Power Lead in / Power Extension	L (Line)	1	16AWG	Black
	N (Neutral)	2	16AWG	White
	GND (Ground)	3	16AWG	Green
Dimming	DIM +	4	22AWG	Purple
	DIM -	5	22AWG	Gray
	N/A	6	22AWG	Yellow

PIN ID:

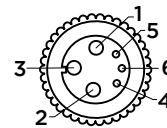
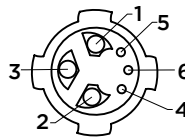

6-Pin Connector is used for the following cables:

1. Fixture in/out
2. MINICBLTJOINT6PIN
3. MINIJUMP6PINMK1000
4. MINIJUMP6PINMK2000
5. MINICBLF6PIN2000
6. MINICBLF6PIN6000

Notes:

1. The top wiring diagram shows only typical connections. Actual wiring depends on the site configuration and installation.
2. The wire connection method shall be determined by local electrical codes and regulations. Wire nuts or screw terminal blocks are recommended for wire connection.
3. Actual number of wall washer can be connected may vary according to cable lengths and signal source.
4. Shield signal cables are recommended for signal protection.

REV.30APR2026

GLOBAL HQ

320 Murray Hill Pkwy
East Rutherford, NJ 07073
U.S.
T: (+1) 212 629 6830
E: Sales-US@GENLEDBrands.com

EUROPEAN HQ

Hogeweyselaan 119
1382 JK Weesp
Netherlands
T: (+31) 346 235 000
E: SalesEurope@GENLEDBrands.com

MEINA HQ

PO Box 371378, #823, Building 4EA
Dubai Airport Free Zone
Dubai, UAE
T: (+971) 4 701 7901
E: SalesMEINA@genledbrands.com

ASIA-PACIFIC HQ

Room 402, Building D
Shenshi Tongchuang Science and Technology Park
No. 16 Hongyin Road
Xingqiang Community, Xinhua Street
Guangming District, Shenzhen, China 518107
T: (+86) 755 8529 0710
E: Sales-Pacific@GENLEDBrands.com