

ARMOR SERIES | MINI EXTERIOR LINEAR FIXTURES

Armor Series Mini Linear fixtures offer a small, sleek anodized aluminum profile with five premium optics options designed for exterior applications. Six brilliant CCTs (2700K-6000K) and four standard lengths allow mixing and matching as needed to fit any project. Choose the mounting style suitable for your design, from tilting stands for focused beam angles in tight spaces to sturdy mounting arms for rock-solid light. The Armor Series Mini Linear comes with a three-year warranty.



GEL-FLUSH™ TECHNOLOGY

The Armor Series Mini Linear fixture is manufactured with GelFlush™ Technology. This proprietary innovation uses a special Dow Corning sealant to protect your lighting from the elements. With Acolyte's Armor Series, there's no leaking and no condensation -- just clear, unobstructed beams of light!



Applications:

Commercial Entertainment Museums Public Spaces



IP66

ORDERING GUIDE

Category	CRI	Input Voltage	Length	Color Temperature	FWHM Beam Angle	Mounting Option
MINI		24				
MINI - Armor MINI	80 - 80+ CRI	24 - 24 V DC	8 - 8.5 in. / 215 mm (6 W)	27 - 2700K	10x40 - 10°x40°	SI - Snap-In
	90 - 90+ CRI		16 - 16.1 in. / 410 mm (12 W)	30 - 3000K	15 - 15°x15°	TS - Tilttable Stand
			24 - 23.8 in. / 605 mm (18 W)	35 - 3500K	20 - 20°x20°	TSL - Large Tilttable Stand
			47 - 46.9 in. / 1190 mm (36 W)	40 - 4000K	35 - 35°x35°	
				50 - 5000K	50 - 50°x50°	
				60 - 6000K		

OPTIONAL ACCESSORIES:

1.) Armor Series Mounting Arms:

Small: ARMORMNT0609
Large: ARMORMNT1422

2.) Symmetric Louver:

MINILOUV215 (215 mm)
MINILOUV410 (410 mm)
MINILOUV605 (605 mm)
MINILOUV1190 (1190 mm)

3.) Asymmetric Louver:

MINIALOUV215 (215 mm)
MINIALOUV410 (410 mm)
MINIALOUV605 (605 mm)
MINIALOUV1190 (1190 mm)

5.) 2 Pin Male to Female Jumper Cable:

MINIJUMPMF1000 (1000 mm)
MINIJUMPMF2000 (2000 mm)

4.) Glare Shield:

MINISHLD215 (215 mm)
MINISHLD410 (410 mm)
MINISHLD605 (605 mm)
MINISHLD1190 (1190 mm)

6.) 2 Pin Female Cable to Bare Wire:

MINICBLFB300 (300 mm)
MINICBLFB500 (500 mm)
MINICBLFB1000 (1000 mm)
MINICBLFB2000 (2000 mm)

DRIVERS:

96 W Non-dimming Driver



Driver Part No.: DRVW2496

0-10V Dimmable Waterproof Drivers



96W Part No.: DRVW249610P
288W Part No.: DRVW2428810P

ELV/MLV Dimmable Drivers



60W Part No.: DRVW2460ELVMLV
96W Part No.: DRVW2496ELVMLV
150W Part No.: DRVW24150ELVMLV
300W Part No.: DRVW24300ELVMLV

AVAILABLE COLOR TEMPERATURES

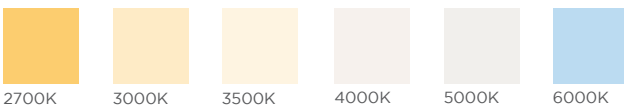

AVAILABLE BEAM ANGLES

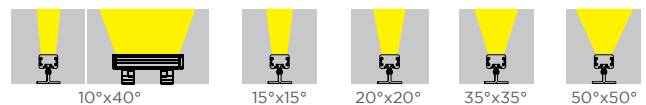

SPECIFICATIONS

Operating Voltage	24 V DC																			
Length	8.5 in. / 215 mm					16.1 in. / 410 mm					23.8 in. / 605 mm					46.9 in. / 1190 mm				
Power Consumption	6 W					12 W					18 W					36 W				
LEDs per Fixture	6 LEDs					12 LEDs					18 LEDs					36 LEDs				
Amperage	0.25 A					0.5 A					0.75 A					1.5 A				
Color Temperature	2700K, 3000K, 3500K 4000K, 5000K, 6000K																			
LED Beam Angle	15° x 15°	20° x 20°	35° x 35°	50° x 50°	10° x 40°	15° x 15°	20° x 20°	35° x 35°	50° x 50°	10° x 40°	15° x 15°	20° x 20°	35° x 35°	50° x 50°	10° x 40°	15° x 15°	20° x 20°	35° x 35°	50° x 50°	10° x 40°
Lumen Output / Foot	585	645	713	752	743	585	645	713	752	743	585	645	713	752	743	585	645	713	752	743
Total Lumens	412	455	503	530	524	786	867	959	1011	999	1151	1269	1404	1480	1462	2283	2517	2785	2935	2900
Max. Run Length	14 fixtures					6 fixtures					6 fixtures					4 fixtures				
Weight	1.06 lb / 0.48 kg					1.87 lb / 0.85 kg					2.65 lb / 1.2 kg					3.3 lb / 1.5 kg				
Control System	0-10V, DALI																			
CRI	80+ or 90+ CRI																			
LED Binning (SDCM)	3-step (80 CRI) or 2-step (90 CRI)																			
Binning Tolerance	+/- 100K																			
Ambient Temperature	-40° F to 122° F (-40° C to 50° C)																			
Housing / Lens Materials	Housing: Extruded Aluminium / Lens: Clear UV Protected PMMA Cover: Tempered Glass End Caps: Extruded Aluminium / Brackets: Extruded Aluminium Housing, bracket, end cap material - 6063 high density aluminum alloy																			
Connector	2 pin power connector																			
Cable Length	11.81 in. / 300 mm																			
Protection Rating	IP66																			
Impact Rating	IK08																			
Mounting Options	Snap-In Clip, Tilttable Stand (140° adjustable), Large Tilttable Stand (180° adjustable), Mounting Arms (available in 2 different sizes)																			
Lamp Life	50,000 hours																			
Certifications	CE, ETL / Luminaires - UL 1598, 3rd Ed., issued September 17, 2008, Rev. October 17, 2012 / Luminaires - CSA C22.2 No.250.0-08, 3rd Ed., issued September 17, 2008, Rev. October 17, 2012 (R2013)																			
Fixture Color Finish	Anodized Silver																			

* ALL LUMEN DATA IS FROM 2700K 80 CRI FIXTURES

SPECIFICATIONS / DIMENSIONS

DIMENSIONS

8.5 in. / 215 mm:

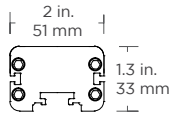
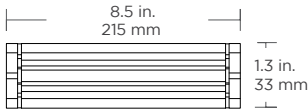

16.1 in. / 410 mm:

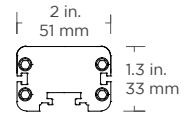
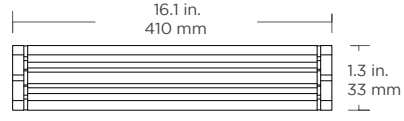

23.8 in. / 605 mm:

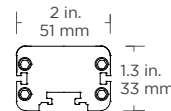
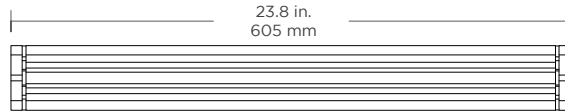

46.9 in. / 1190 mm:

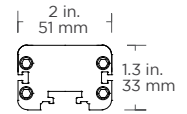
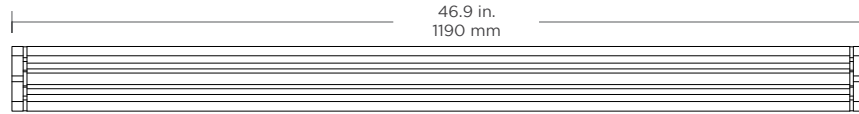

MOUNTING HARDWARE

Snap-In Clip

For narrow installations where mounting clips need to be installed first

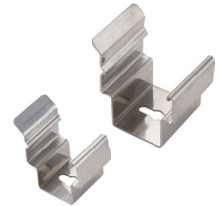
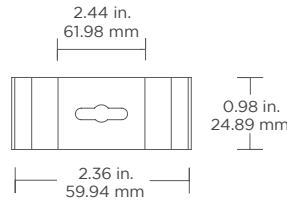
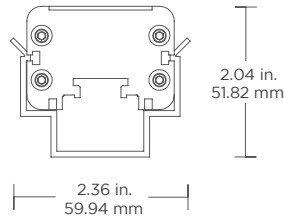

Tiltable Stand

For adjustable mounting angles from 0-140°

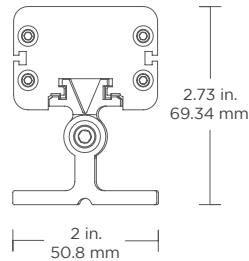

Large Tiltable Stand

For adjustable mounting angles from 0-180°

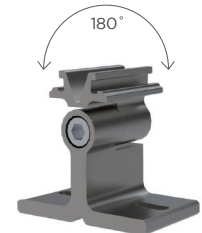
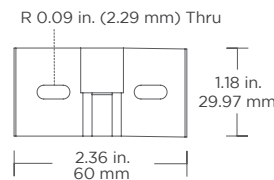
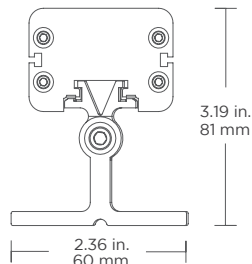

MOUNTING HARDWARE / ACCESSORIES

MOUNTING HARDWARE

Mounting Arms

Small Mounting Arm Part Number: ARMORMNT0609
Large Mounting Arm Part Number: ARMORMNT1422

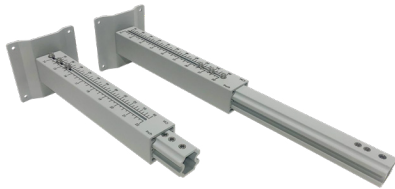

Armor Series Mounting Arm

Adjustable mounts (in 3 sizes) help set desired angle and distance from lighting surface

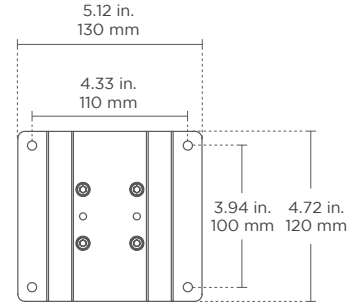
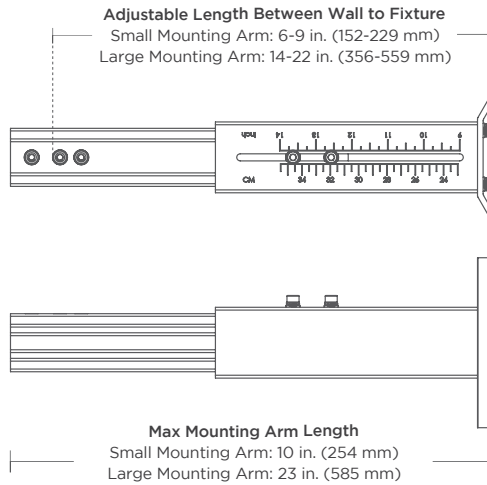

ACCESSORIES

Part Number: MINILOUV



Louver

For glare reduction
Note: This will affect beam angle

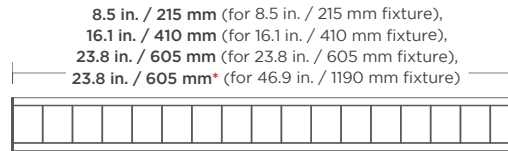

Not recommended for exterior applications
* Needs two 24 in. Louvers for 46.9 in. fixture

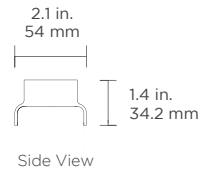

Part Number: MINIALOUV



Asymmetric Louver

For glare reduction
Note: This will affect beam angle

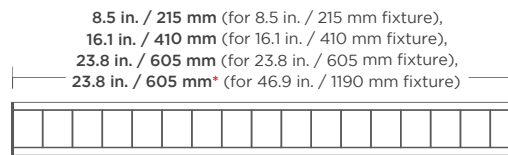

Not recommended for exterior applications
* Needs two 24 in. Asymmetric Louvers for 46.9 in. fixture

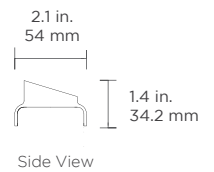

Part Number: MINISHLD



Glare Shield

To reduce glare or redirect light

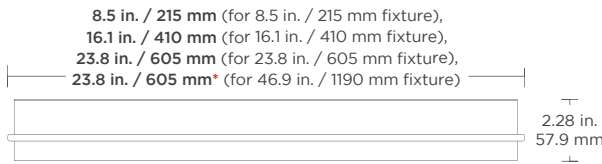

Adds 2 in./50.8 mm to the height of the fixture
* Needs two 24 in. Glare Shields for 46.9 in. fixture

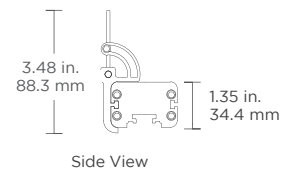

Part Number: MINICBLFB



2 Pin Female Cable To Bare Wire
To bare wire for incoming power

Part Number: MINIJUMPMF



2 Pin Male To Female Jumper Cable
To connect 2 pin male connector to 2 pin female connector
Default cable length: 11.81 in. / 30 cm
(Consult factory for custom length)

CONNECTION

NON-DIMMING FOR CASE 1:

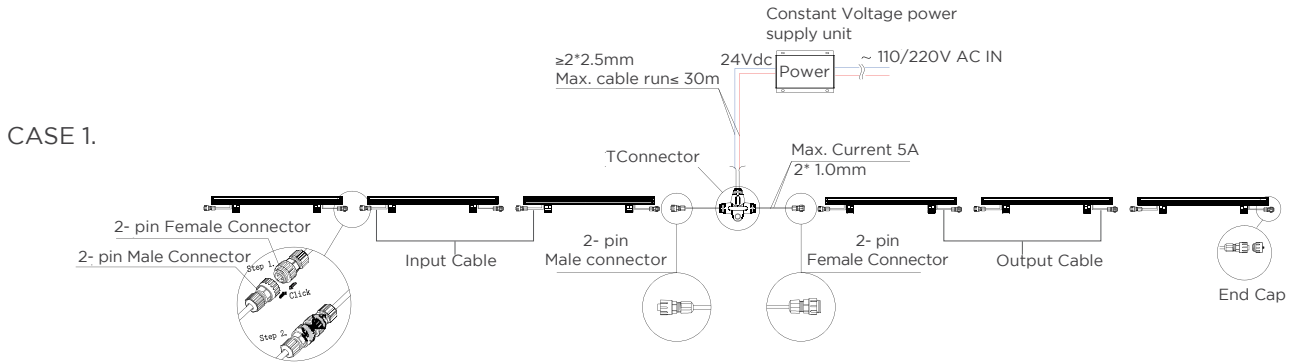

CASE 2.

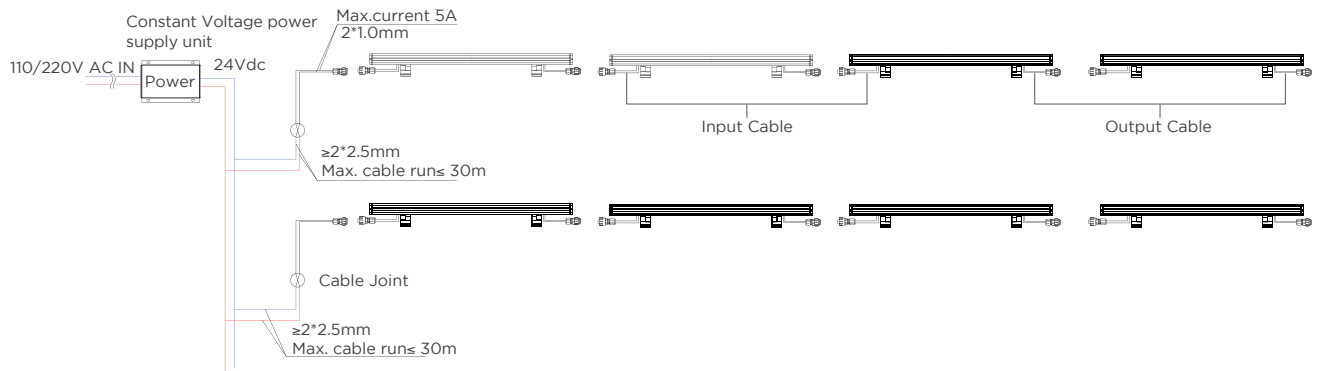

0-10V DIMMING:

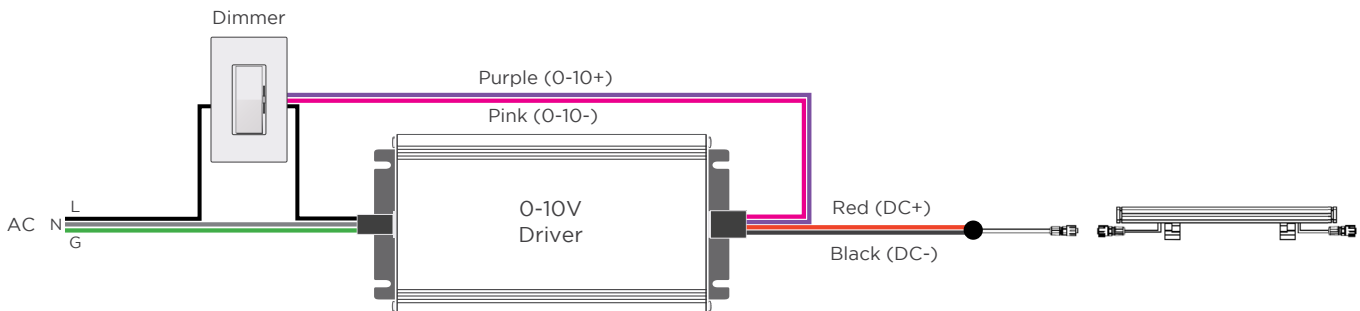

CONNECTION

DALI DIMMING:

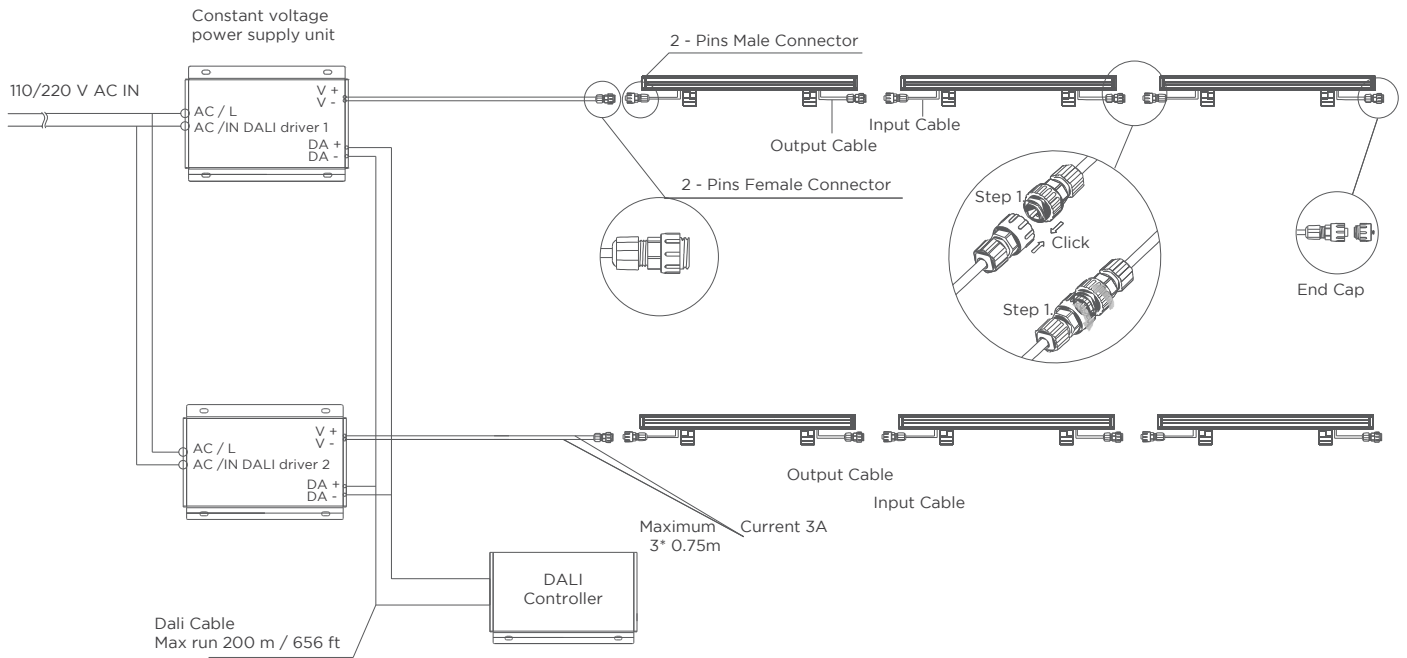

CONNECTORS:

