

AR20 CHANNEL FIXTURE

AR20 Channel is a recessed aluminum channel with a 100-degree beam angle. We offer choices of clear, milky and black flat lens or square milky lens to create a full range of light output options. Design a custom fixture with AR20 and our RibbonLyte products.



- Available for field assembly or factory assembly
- 1.18 in. (30 mm) wide by 0.8 in. (20.4 mm) deep with flat lens
- Beam angles: 100° with clear, milky or black lens, 100°x150° with square milky lens
- Wattage Range from 0.75 W/ft (2.46 W/m) to 8.8 W/ft (28.9 W/m)
- Static White delivered lumen range from 44 lm/ft (145 lm/m) up to 737 lm/ft (2417 lm/m)
- Clear Lens, Milky Lens, Black Lens or Square Milky Lens



HOUSING FINISHES

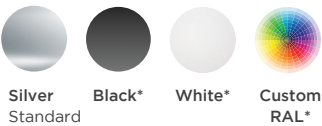

*Additional fee applies

LENS FINISHES

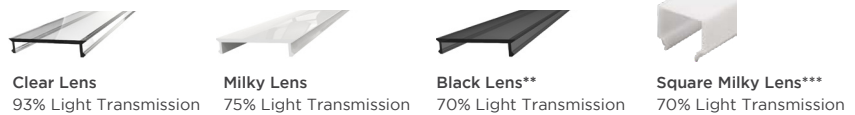

** Our black lens offers great diffusion and helps hide fixtures that aren't in use.
*** For interior applications only

AVAILABLE COLORS & COLOR TEMPERATURES

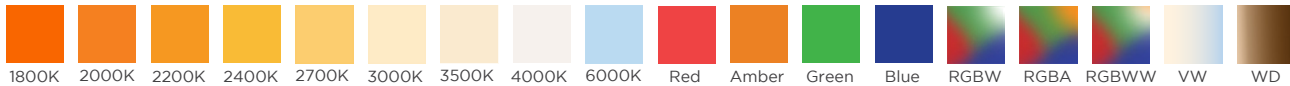

DIMENSIONS

AR20 Channel	Mounting Clip	Spring Clip
<p>1.18 in. (30 mm) 0.9 in. (23 mm) 0.83 in. (21 mm) 100° 0.73 in. (18.5 mm) 0.49 in. (12.4 mm) 0.8 in. (20.4 mm)</p> <p>Width: 1.18 in. (30 mm) Height: 0.8 in. (20.4 mm) Internal Width: 0.83 in. (21 mm) Internal Height: 0.73 in. (18.5 mm)</p>	<p>Side View</p> <p>0.98 in. (25 mm) 0.28 in. (7.2 mm)</p> <p>Width: 0.98 in. (25 mm) Length: 0.98 in. (25 mm)</p> <p>Top View</p> <p>0.98 in. (25 mm) 0.98 in. (25 mm)</p>	<p>Front View</p> <p>1.67 in. (42.3 mm) 0.98 in. (25 mm)</p> <p>Side View</p> <p>2.64 in. (67 mm) 0.79 in. (20 mm) 1.81 in. (46 mm) 0.32 in. (8.2 mm) 0.98 in. (25 mm)</p>
<p>1.18 in. (30 mm) 0.9 in. (23 mm) 0.83 in. (21 mm) 100°x150° 0.73 in. (18.5 mm) 0.49 in. (12.4 mm) 1.32 in. (33.6 mm) 1.24 in. (31.6 mm)</p> <p>Width: 1.18 in. (30 mm) Height: 1.32 in. (33.6 mm) Internal Width: 0.83 in. (21 mm) Internal Height: 1.24 in. (31.6 mm)</p> <p>Note: Raised lens is for interior applications only</p>	<p>Assembled Views</p> <p>0.87 in. (22 mm) 1.42 in. (36.1 mm)</p> <p>Width: 0.98 in. (25 mm) Height: 0.9 in. (22.9 mm)</p> <p>Width: 0.98 in. (25 mm) Height: 1.42 in. (36.1 mm)</p>	<p>Front View</p> <p>Width: 0.98 in. (25 mm) Height: 1.81 in. (46 mm)</p>

NOTE: Exterior channel applications should be securely attached to the mounting surface with appropriate screws and/or liquid nails. Acolyte strongly recommends field assembly for exterior applications. Use mounting clips for interior applications only.

SPECIFICATIONS

Beam Angle	100° with Clear, Milky or Black Lens, 100°x150° with Square Milky Lens
Lens Type	Clear Lens, Milky Lens, Black Lens, Square Milky Lens
Length	Channel is sold by the foot and cut to your exact desired length. Required amount of mounting clips included.
Operating Voltage	24V
Dimming	MLV / 0-10 Volt / ELV / DALI / DMX
Operating Temperature	-40° F to 158° F (-40° C to 70° C)
Colors	1800K, 2000K, 2200K, 2400K, 2700K, 3000K, 3500K, 4000K, 6000K, Red, Amber, Green, Blue, RGBA, RGBW, RGBWW, VW, Warm Dim (1800K, 2000K, 2200K only available in IP20)
CRI	90+ CRI (Static white only)
Lamp Life	L70 at 50,000 Hours
MacAdam Ellipses (SDCM)	2-Step Binning (For Static White LEDs only)
Certifications	UL Listed UL 2108 Issued: 2004/02/27 Ed: 1 Rev: 2014/02/24 Low Voltage Lighting Systems CSA C22.2#9.0 Issued: 1996/06/01 Ed: 1 (R2011) General Requirements for Luminaries; with Gen. Inst. 1: 1997, Gen Inst. 2: 1998. ROHS compliant

ACCESSORIES (SEE PART NUMBERS AT STEP 4 ON PAGE 3)

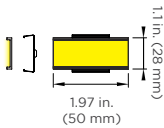
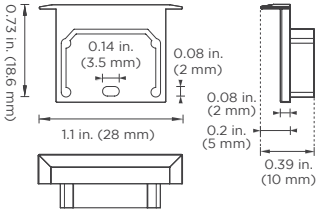
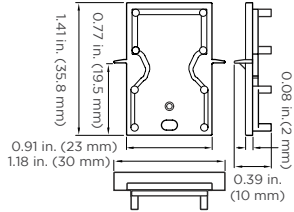
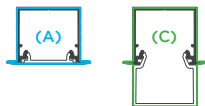
<p>180° Coupler</p> 	<p>End Cap (A) for channel with Flat Lens</p>  <p>End Cap Options:</p> <ol style="list-style-type: none"> 1. Use End Cap (A) for channel with Flat Lens 2. Use End Cap (C) for channel with Square Milky Lens 	<p>End Cap (C) for channel with Square Milky Lens</p> 
		

Acolyte does not warrant or represent that the information is free from errors or omission. The information may change without notice and Acolyte is not in any way liable for the accuracy of any information printed and stored or in any way interpreted or used.

ORDERING GUIDE

STEP 1 Complete Channel Part Number

CHANNEL	LENS	HOUSING COLOR	MOUNTING TYPE	END CAP
CHAR20				
CHAR20 - AR20 Channel	C - Clear Lens SM - Square Milky Lens* M - Milky Lens * For interior applications only BK - Black Lens	SV - Silver BK - Black WH - White	C - Mounting Clips S - Spring Clips Consult factory for custom housing colors	A - End Cap for channel with Flat Lens C - End Cap for channel with Square Milky Lens

STEP 2 Complete RibbonLyte Part Number

CATEGORY	CRI	RIBBON TYPE & IP RATING		
RB				
RB - RibbonLyte	0 - Static Color, Color Changing 90 - 90+ CRI Static White	LINEA20 - Linea RibbonLyte IP20 SWS220 - Static White Series 2 IP20 SWS265 - Static White Series 2 IP65 SWS268 - Static White Series 2 IP68 SCS220 - Static Color Series 2 IP20 SCS265 - Static Color Series 2 IP65 SCS268 - Static Color Series 2 IP68	RGBWW20 - RGBWW 5-in-1 IP20 RGBWS220 - RGBW Series 2 IP20 RGBWS265 - RGBW Series 2 IP65 RGBWS268 - RGBW Series 2 IP68 VWS220 - VW Series 2 IP20 VWS265 - VW Series 2 IP65 VWS268 - VW Series 2 IP68	WD20 - Warm Dim IP20 WD65 - Warm Dim IP65 WD68 - Warm Dim IP68

NOTE: To ensure waterproofing standards are met, IP65 and IP68 RibbonLyte can NOT be cut in the field.

WATTAGE	COLOR
0.75 - 0.75 W/ft (2.46 W/m - Static White, Static Color)	18 - 1800K
1.0 - 1.0 W/ft (3.3 W/m - Variable White)	20 - 2000K
1.5 - 1.5 W/ft (4.9 W/m - Static White, Static Color)	22 - 2200K
2.2 - 2.2 W/ft (7.2 W/m - Static White, Static Color)	24 - 2400K
2.4 - 2.4 W/ft (8 W/m - Static White)	27 - 2700K
3.0 - 3.0 W/ft (9.8 W/m - Static White, Static Color, Variable White)	30 - 3000K
4.3 - 4.3 W/ft (14 W/m - Static White)	35 - 3500K
4.4 - 4.4 W/ft (14.4 W/m - Static White, Static Color, RGBW, RGBWW, RGBA)	40 - 4000K
5.2 - 5.2 W/ft (17.1 W/m - Warm Dim)	60 - 6000K
5.0 - 5.0 W/ft (16.4 W/m - Static White, Static Color)	R - Red
5.5 - 5.5 W/ft (18.0 W/m - RGBW, RGBA)	A - Amber
6.0 - 6.0 W/ft (19.7 W/m - Static White, Static Color, Variable White)	G - Green
6.1 - 6.1 W/ft (20 W/m - Variable White)	B - Blue
8.8 - 8.8 W/ft (28.86 W/m - RGBW, RGBWW, RGBA)	

CONNECTION OPTIONS (See diagrams on the right)

Custom Length (ft.)

- 1 - End Feed Bare Wire Connection
- 2 - Back Feed Bare Wire Connection
- 3 - Side Feed Bare Wire Connection
- 4 - End Feed with IP67 Male Coupler
- 5 - Soldered Daisy Chain
- 6 - Daisy Chain With IP67 Couplers

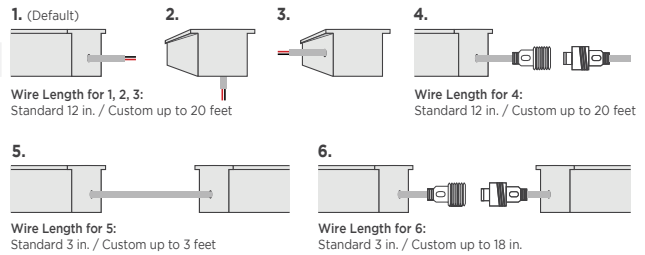

STEP 3 Complete Assembly Option & Length

ASSEMBLY OPTION	LENGTH (Standard factory assembled length up to 6 ft 6.7 in. / 2 m)
FI - Field Assembly	
FA - Factory Assembly* (not recommended for exterior applications)	

* Factory assembled runs exceeding 6 ft 6.7 in. (2 m) will be split into multiple daisy chained fixtures.

STEP 4 Add Accessories

ACCESSORIES

CHCOUP180AR20SV - 180° Coupler Silver

DO NOT BUTT END CAPS AGAINST EACH OTHER WHEN CREATING LONGER FIXTURES
 Acolyte STRONGLY SUGGESTS field assembly (without using interior end caps) for direct-view fixtures of more than 6 ft 6.7 in. (2 m) in length. Field assembly without interior end caps will eliminate gaps or dead spots that can be caused by butting interior end caps against each other.

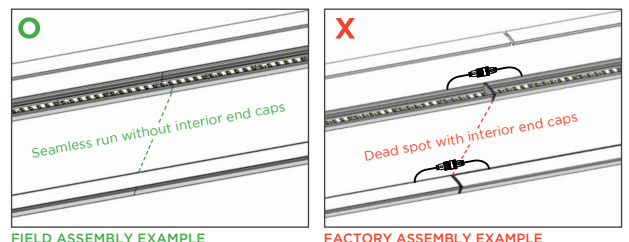

RIBBONLYTE SPECIFICATIONS & COMPATIBILITY

Available Wattage	Cuttable Length	LED Pitch	Color Temp.	lm/W without Lens	Delivered Lumens with Clear Lens (lm/ft / lm/m)	Delivered Lumens with Milky Lens (lm/ft / lm/m)	Delivered Lumens with Black Lens (lm/ft / lm/m)	Delivered Lumens with Square Lens (lm/ft / lm/m)	Max Length	Compatible with Channel		
										IP20	IP65	IP68
0.75 Static White Series 2	1.97 in. (50 mm)	48 LEDs/ft (160 LEDs/m)	1800K	84	59 / 192	47 / 155	44 / 145	44 / 145	IP20: 49 ft (15 m) IP65/IP68: 32.8 ft (10 m)	✓	✓	✓
			2000K	99	69 / 227	56 / 183	52 / 171	52 / 171				
			2200K	109	76 / 249	61 / 201	57 / 188	57 / 188				
			2400K	113	79 / 259	64 / 209	59 / 195	59 / 195				
			2700K	123	86 / 281	69 / 227	65 / 212	65 / 212				
			3000K	123	86 / 281	69 / 227	65 / 212	65 / 212				
			3500K	130	91 / 297	73 / 240	68 / 224	68 / 224				
			4000K	134	93 / 307	75 / 247	70 / 231	70 / 231				
6000K	131	91 / 300	74 / 242	69 / 226	69 / 226							
1.5 Static White Series 2	1.97 in. (50 mm)	48 LEDs/ft (160 LEDs/m)	1800K	84	117 / 384	95 / 310	88 / 289	88 / 289	IP20: 49 ft (15 m) IP65/IP68: 32.8 ft (10 m)	✓	✓	✓
			2000K	98	137 / 384	110 / 362	103 / 338	103 / 338				
			2200K	109	152 / 499	123 / 402	114 / 375	114 / 375				
			2400K	113	158 / 517	127 / 417	119 / 389	119 / 389				
			2700K	123	172 / 563	138 / 454	129 / 424	129 / 424				
			3000K	123	172 / 563	138 / 454	129 / 424	129 / 424				
			3500K	129	180 / 590	145 / 476	135 / 444	135 / 444				
			4000K	134	187 / 613	151 / 495	141 / 462	141 / 462				
6000K	131	183 / 600	147 / 484	138 / 451	138 / 451							
2.2 Static White Series 2	1.97 in. (50 mm)	48 LEDs/ft (160 LEDs/m)	1800K	83	170 / 557	137 / 449	128 / 419	128 / 419	IP20: 42 ft (12.8 m) IP65/IP68: 32.8 ft (10 m)	✓	✓	✓
			2000K	96	196 / 644	158 / 520	148 / 485	148 / 485				
			2200K	106	217 / 712	175 / 574	163 / 536	163 / 536				
			2400K	111	227 / 745	183 / 601	171 / 561	171 / 561				
			2700K	120	246 / 806	198 / 650	185 / 606	185 / 606				
			3000K	122	250 / 819	201 / 660	188 / 616	188 / 616				
			3500K	127	260 / 852	210 / 687	196 / 642	196 / 642				
			4000K	133	272 / 893	219 / 720	205 / 672	205 / 672				
6000K	128	262 / 859	211 / 693	197 / 647	197 / 647							
3.0 Static White Series 2	1.97 in. (50 mm)	48 LEDs/ft (160 LEDs/m)	1800K	84	234 / 769	189 / 620	176 / 579	176 / 579	IP20: 36 ft (11 m) IP65/IP68: 32.8 ft (10 m)	✓	✓	✓
			2000K	98	273 / 897	221 / 723	206 / 675	206 / 675				
			2200K	108	301 / 989	243 / 797	227 / 744	227 / 744				
			2400K	109.8	306 / 1005	247 / 811	231 / 756	231 / 756				
			2700K	122.9	343 / 1125	277 / 907	258 / 847	258 / 847				
			3000K	130	363 / 1190	293 / 960	273 / 896	273 / 896				
			3500K	133	371 / 1217	299 / 982	279 / 916	279 / 916				
			4000K	133	371 / 1217	299 / 982	279 / 916	279 / 916				
6000K	128	357 / 1172	288 / 945	269 / 882	269 / 882							
4.4 Static White Series 2	1.97 in. (50 mm)	48 LEDs/ft (160 LEDs/m)	1800K	81	331 / 1087	267 / 877	249 / 818	249 / 818	28 ft 4 in. (8.64 m)	✓	✓	✓
			2000K	95	389 / 1275	314 / 1029	293 / 960	293 / 960				
			2200K	105	430 / 1410	347 / 1137	323 / 1061	323 / 1061				
			2400K	109	446 / 1463	360 / 1180	336 / 1101	336 / 1101				
			2700K	122	499 / 1638	403 / 1321	376 / 1233	376 / 1233				
			3000K	129	528 / 1732	426 / 1397	397 / 1304	397 / 1304				
			3500K	132	540 / 1772	436 / 1429	407 / 1334	407 / 1334				
			4000K	132	540 / 1772	436 / 1429	407 / 1334	407 / 1334				
6000K	126	516 / 1692	416 / 1364	388 / 1273	388 / 1273							
5.0 Static White Series 2	1.4 in. (35.7 mm)	68 LEDs/ft (224 LEDs/m)	1800K	83	386 / 1266	311 / 1021	291 / 953	293 / 953	IP20: 33 ft 4 in. (10.1 m) IP65/IP68: 32.8 ft (10 m)	✓	✓	✓
			2000K	98	456 / 1495	368 / 1206	343 / 1125	343 / 1125				
			2200K	107	498 / 1632	401 / 1316	375 / 1229	375 / 1229				
			2400K	110	511 / 1675	412 / 1351	384 / 1261	384 / 1261				
			2700K	123	571 / 1875	461 / 1512	430 / 1411	430 / 1411				
			3000K	130	605 / 1983	488 / 1599	455 / 1493	455 / 1493				
			3500K	133	618 / 2029	499 / 1636	466 / 1527	466 / 1527				
			4000K	133	618 / 2029	499 / 1636	466 / 1527	466 / 1527				
6000K	127	591 / 1937	476 / 1562	445 / 1458	445 / 1458							
6.0 Static White Series 2	1.4 in. (35.7 mm)	68 LEDs/ft (224 LEDs/m)	1800K	82	458 / 1501	369 / 1211	344 / 1130	344 / 1130	28 ft (8.5 m)	✓	✓	✓
			2000K	95	530 / 1739	428 / 1403	399 / 1309	399 / 1309				
			2200K	106	591 / 1941	477 / 1565	445 / 1461	445 / 1461				
			2400K	109	608 / 1995	491 / 1609	458 / 1502	458 / 1502				
			2700K	122	681 / 2233	549 / 1801	512 / 1681	512 / 1681				
			3000K	129	720 / 2362	581 / 1905	542 / 1778	542 / 1778				
			3500K	132	737 / 2417	594 / 1949	554 / 1819	554 / 1819				
			4000K	132	737 / 2417	594 / 1949	554 / 1819	554 / 1819				
6000K	126	703 / 2307	567 / 1860	529 / 1736	529 / 1736							

RIBBONLYTE SPECIFICATIONS & COMPATIBILITY

Available Wattages	Cuttable Length	LED Pitch	Color Temp.	lm/W without Lens	Delivered Lumens with Clear Lens (lm/ft / lm/m)	Delivered Lumens with Milky Lens (lm/ft / lm/m)	Delivered Lumens with Black Lens (lm/ft / lm/m)	Delivered Lumens with Square Lens (lm/ft / lm/m)	Max Length	Compatible with Channel		
										IP20	IP65	IP68
0.75 Static Color Series 2	1.97 in. (50 mm)	48 LEDs/ft (160 LEDs/m)	Red	41	29 / 94	23 / 76	22 / 71	22 / 71	IP20: 49 ft (15 m) IP65/ IP68: 32.8 ft (10 m)	✓	✓	✓
			Green	175	122 / 400	98 / 323	92 / 301	92 / 301				
			Blue	19	13 / 43	11 / 35	10 / 33	10 / 33				
			Amber	34	24 / 78	19 / 63	18 / 59	18 / 59				
1.5 Static Color Series 2	1.97 in. (50 mm)	48 LEDs/ft (160 LEDs/m)	Red	42	59 / 192	47 / 155	44 / 145	44 / 145	IP20: 49 ft (15 m) IP65/ IP68: 32.8 ft (10 m)	✓	✓	✓
			Green	160	223 / 732	180 / 591	168 / 551	168 / 551				
			Blue	18	25 / 82	20 / 66	19 / 62	19 / 62				
			Amber	34	47 / 156	38 / 125	36 / 117	36 / 117				
2.2 Static Color Series 2	1.97 in. (50 mm)	48 LEDs/ft (160 LEDs/m)	Red	42	86 / 282	69 / 227	65 / 212	65 / 212	IP20: 42 ft (12.8 m) IP65/ IP68: 32.8 ft (10 m)	✓	✓	✓
			Green	145	297 / 973	239 / 785	223 / 733	223 / 733				
			Blue	18	37 / 121	30 / 97	28 / 91	28 / 91				
			Amber	34	70 / 228	56 / 184	52 / 172	52 / 172				
3.0 Static Color Series 2	1.97 in. (50 mm)	48 LEDs/ft (160 LEDs/m)	Red	40	112 / 366	90 / 295	84 / 267	84 / 267	32.8 ft (10 m)	✓	✓	✓
			Green	127	354 / 1162	286 / 937	267 / 875	267 / 875				
			Blue	25	70 / 229	56 / 185	53 / 172	53 / 172				
			Amber	29	81 / 265	65 / 214	61 / 200	61 / 200				
4.4 Static Color Series 2	1.97 in. (50 mm)	48 LEDs/ft (160 LEDs/m)	Red	38	155 / 510	125 / 411	117 / 384	117 / 384	29 ft (8.8 m)	✓	✓	✓
			Green	117	479 / 1571	386 / 1267	360 / 1182	360 / 1182				
			Blue	24	98 / 322	79 / 260	74 / 243	74 / 243				
			Amber	25	102 / 336	83 / 271	77 / 253	77 / 253				
5.0 Static Color Series 2	1.4 in. (35.7 mm)	68 LEDs/ft (224 LEDs/m)	Red	37	172 / 564	139 / 455	130 / 425	130 / 425	30 ft (9.14 m)	✓	✓	✓
			Green	116	539 / 1770	435 / 1427	406 / 1332	406 / 1332				
			Blue	24	112 / 366	90 / 295	84 / 276	84 / 276				
			Amber	26	121 / 397	98 / 320	91 / 299	91 / 299				
6.0 Static Color Series 2	1.4 in. (35.7 mm)	68 LEDs/ft (224 LEDs/m)	Red	37	206 / 677	167 / 546	155 / 510	155 / 510	28 ft (8.5 m)	✓	✓	✓
			Green	113	631 / 2069	509 / 1668	475 / 1557	475 / 1557				
			Blue	23	128 / 421	104 / 340	97 / 317	97 / 317				
			Amber	24	134 / 439	108 / 354	101 / 331	101 / 331				
2.4 Static White Linea	1.97 in. (50 mm)	146 LEDs/ft (480 LEDs/m)	2700K	67	149.7 / 491	120.8 / 396	112.7 / 369.6	112.7 / 369.6	21.3 ft (6.5 m)	✓	N/A	N/A
			3000K	71	158.1 / 519.9	127.5 / 419.3	119 / 391.3	119 / 391.3				
			3500K	83	185.1 / 608.2	149.3 / 490.5	139.3 / 457.8	139.3 / 457.8				
			4000K	83	185.1 / 608.2	149.3 / 490.5	139.3 / 457.8	139.3 / 457.8				
3.0 Static White Linea	1.97 in. (50 mm)	146 LEDs/ft (480 LEDs/m)	2700K	66	184.1 / 604.5	148.5 / 487.5	138.6 / 455	138.6 / 455	21.3 ft (6.5 m)	✓	N/A	N/A
			3000K	73	203.7 / 668.7	164.3 / 539.3	153.3 / 503.3	153.3 / 503.3				
			3500K	78	217.6 / 714.2	175.5 / 576	163.8 / 537.6	163.8 / 537.6				
			4000K	83	231.6 / 759.8	186.8 / 612.8	174.3 / 571.9	174.3 / 571.9				
4.3 Static White Linea	1.97 in. (50 mm)	146 LEDs/ft (480 LEDs/m)	2700K	75	300.4 / 983.9	242.3 / 793.5	226.1 / 740.6	226.1 / 740.6	24.6 ft (7.5 m)	✓	N/A	N/A
			3000K	78	311.6 / 023	251.3 / 825	234.5 / 770	234.5 / 770				
			3500K	86	344.1 / 129	277.5 / 910.5	259 / 849.8	259 / 849.8				
			4000K	86	344.1 / 29	277.5 / 910.5	259 / 849.8	259 / 849.8				
6.1 Variable White Linea	1.09 in. (27.78 mm)	175 LEDs/ft (576 LEDs/m)	2700K + 6500K	95	539.4 / 1769.8	435 / 427.3	406 / 332.1	406 / 332.1	16.4 ft (5 m)	✓	N/A	N/A

RIBBONLYTE SPECIFICATIONS & COMPATIBILITY

Available Wattages	Cuttable Length	LED Pitch	Color Temp.	lm/W without Lens	Delivered Lumens with Clear Lens (lm/ft / lm/m)	Delivered Lumens with Milky Lens (lm/ft / lm/m)	Delivered Lumens with Black Lens (lm/ft / lm/m)	Delivered Lumens with Square Lens (lm/ft / lm/m)	Max Length	Compatible with Channel		
										IP20	IP65	IP68
1.0 Variable White Series 2	1.97 in. (50 mm)	42 LEDs/ft (140 LEDs/m)	2000K + 6500K	85	79 / 259	64 / 209	60 / 195	60 / 195	32.8 ft (10 m)	✓	✓	✓
3.0 Variable White Series 2	1.97 in. (50 mm)	42 LEDs/ft (140 LEDs/m)	2000K + 6500K	80	223 / 732	180 / 591	168 / 551	168 / 551	32.8 ft (10 m)	✓	✓	✓
6.0 Variable White Series 2	1.97 in. (50 mm)	42 LEDs/ft (140 LEDs/m)	2000K + 6500K	75	419 / 1373	338 / 1107	315 / 1033	315 / 1033	19 ft 8 in. (6 m)	✓	✓	✓
4.4 RGBW Series 2	1.97 in. (50 mm)	36 LEDs/ft (120 LEDs/m)	RGBW	45	188.1 / 617.2	148.5 / 487.2	138.6 / 454.7	138.6 / 454.7	19 ft 8 in. (6 m)	✓	N/A	N/A
5.5 RGBW Series 2	1.97 in. (50 mm)	36 LEDs/ft (120 LEDs/m)	RGBW	59	308.8 / 1013.0	243.3 / 798.5	227.2 / 745.3	227.2 / 745.3	IP65: 16 ft 4 in. (5 m) IP68: 19 ft 7.9 in. (6 m)	N/A	✓	✓
8.8 RGBW Series 2	1.97 in. (50 mm)	36 LEDs/ft (120 LEDs/m)	RGBW	61	510.2 / 1673.8	402.6 / 1320.9	375.8 / 1232.9	375.8 / 1232.9	16 ft 4 in. (5 m)	✓	N/A	N/A
4.4 5-in-1 RGBWW	2.46 in. (62.5 mm)	29 LED/ft (96 LED/m)	RGBWW	59	241.4 / 792.1	194.7 / 638.8	181.7 / 596.2	181.7 / 596.2	16 ft 4 in (5 m)	✓	N/A	N/A
8.8 5-in-1 RGBWW	2.46 in. (62.5 mm)	29 LED/ft (96 LED/m)	RGBWW	50	409.2 / 1342.6	330.0 / 1082.7	308 / 1010.5	308 / 1010.5	11 ft 6 in (3.5 m)	✓	N/A	N/A
5.2 Warm Dim	3.94 in. (100 mm)	36 LEDs/ft (120 LEDs/m)	WARM DIM	55	266 / 873	215 / 704	200 / 657	200 / 657	16 ft 4 in. (5 m)	✓	✓	✓

DIODE VISIBILITY CHART (Data below applies to installations with Milky lens only)

<p>No Visible Diode = N Note: Linea RibbonLyte has no visible diode</p>			<p>With Visible Diode = Y</p>						
Static White & Static Color RibbonLyte			Color Changing RibbonLyte						
0.75/1.5/2.2	3.0/4.4	5.0/6.0	4.4 RGBW Series 2	5.5 RGBW Series 2	8.8 RGBW Series 2	4.4 5-in-1 RGBWW	8.8 5-in-1 RGBWW	Warm Dim	Variable White
IP20 IP65 IP68	IP20 IP65 IP68	IP20 IP65 IP68	IP20	IP65 IP68	IP20	IP20	IP20	IP20 IP65 IP68	IP20 IP65 IP68
N	N	N	N	N	N	N	N	N	N

AVAILABLE DRIVERS / CONTROLLERS AND DIMMING OPTIONS / WIRE GAUGE CHART

NON-DIMMING ELECTRONIC DRIVERS



30W, 60W, 96W
Non-Dimming Electronic
Class 2 Drivers

Part No.:
• DRVW2430 (30 Watt)
• DRVW2460 (60 Watt)
• DRVW2496 (96 Watt)
Output Voltage: 24 V
Voltage Range: 120-277 VAC
IP Rating: Dry or Damp
UL Listed



240W, 320W
Non-Dimming
Electronic Drivers

Part No.:
• DRVW24240 (240 Watt)
• DRVW24320 (320 Watt)
Output Voltage: 24 V
Voltage Range: 90-305 VAC
IP Rating: Dry or Damp
UL Recognized

ELV & MLV DRIVERS



60W, 96W, 150W, 300W, 600W
ELV/MLV Dimmable Drivers

Part No.:
• DRVW2460ELVMLV (60 Watt)
• DRVW2496ELVMLV (96 Watt)
• DRVW24150ELVMLV (150 Watt)
• DRVW24300ELVMLV (300 Watt)
Line Voltage Dimmable Drivers
Output Voltage: 24 V
Voltage Range: 100-277 VAC
IP Rating: IP67
UL, CE, and CSA Listed

0-10V DRIVERS



0-10V Dimmable Waterproof Drivers

96W Part No.: DRVW249610P
288W Part No.: DRVW2428810P
Output Voltage: 24 V (+/- 0.5V)
Voltage Range: 100-277 VAC
Environmental Rating: UL Wet Location
UL Listed



0-10V Dimmable 90W VW/WD Driver

Part No.: DRVRFWDVW2490120

DMX CONTROLLER AND PART NUMBER - FOR COLOR CHANGING VERSIONS



GLASS TOUCH
WALL CONTROLLERS
Part Number: AWCRCBWWBK
AWCVWBK



1 ZONE WALL CONTROLLER
Part Number: DMXCTRLG



5 ZONE WALL CONTROLLER
Part Number: DMXCTRL



10 ZONE WALL CONTROLLER
Part Number: DMXCTRLD

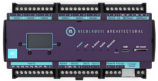

2 UNIVERSE DMX CONTROLLER
Part Number: DMXCTRLDR2U



4 CHANNEL WATERPROOF
DMX INTERFACE
Part Number: DMXINFWLCD4



5 CHANNEL
DMX INTERFACE
Part Number: DMXINFOLED5



DMX OPTO SPLITTER
Part Number: DMXOS8

6 UNIVERSE DMX CONTROLLER
Part Number: DMXCTRLDR6U

DRIVER AND RIBBONLYTE AT FULL LOAD

Wattages	30		60		96		150		200		240		300		320		
	Wire Gauge	Feet	Meters	Feet	Meters	Feet	Meters	Feet	Meters	Feet	Meters	Feet	Meters	Feet	Meters	Feet	Meters
24 AWG / 0.25 mm ²	14	4.27	9	2.74	5.5	1.68	3.75	1.14	2.75	0.84	2.25	0.69	1.75	0.53	1.75	0.53	0.53
22 AWG / 0.34 mm ²	22	6.71	14	4.27	9	2.74	5.75	1.75	4.5	1.37	3.5	1.07	2.75	0.84	2.75	0.84	0.84
20 AWG / 0.5 mm ²	35	10.67	23	7.01	14	4.27	9	2.74	7	2.13	5.75	1.75	4.5	1.37	4.25	1.30	1.30
18 AWG / 0.75 mm ²	56	17.07	37	11.28	23	7.01	15	4.57	11	3.35	9	2.74	7.5	2.29	7	2.13	2.13
16 AWG / 1.5 mm ²	90	27.44	60	18.29	37	11.28	24	7.32	18	5.49	15	4.57	12	3.66	11	3.35	3.35
14 AWG / 2.5 mm ²	142	43.29	95	28.96	59	17.99	38	11.59	28	8.54	23	7.01	19	5.79	17	5.18	5.18
12 AWG / 4 mm ²	226	68.90	151	46.04	94	28.66	60	18.29	45	13.72	37	11.28	30	9.15	28	8.54	8.54
10 AWG / 6 mm ²	360	109.76	240	73.17	150	45.73	96	29.27	72	21.95	60	18.29	48	14.63	45	13.72	13.72
8 AWG / 10 mm ²	574	175.00	381	116.16	239	72.87	153	46.65	115	35.06	95	28.96	76	23.17	71	21.65	21.65

WIRING DIAGRAMS

0-10V

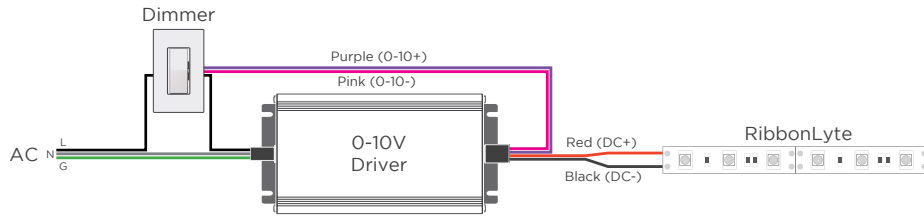

MLV / ELV

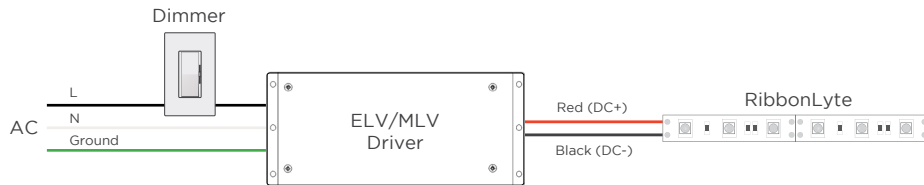

DMX

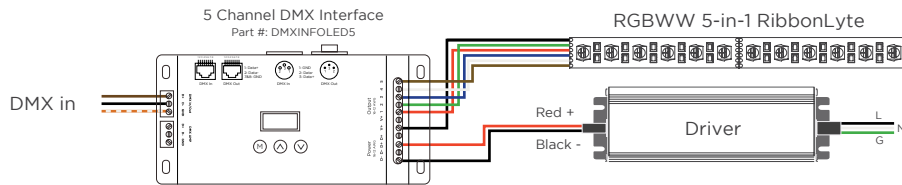

WARM DIM

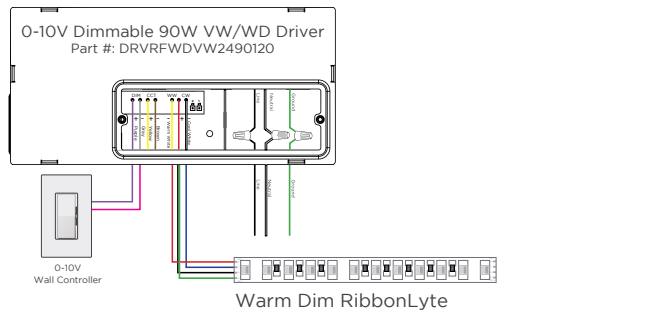

2-CHANNEL VARIABLE WHITE DIMMING

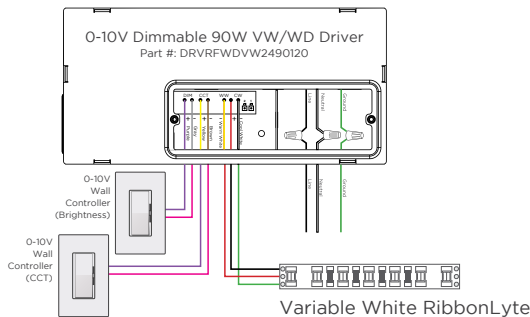

DMX WIRING DIAGRAM - COMPATIBLE WITH ALL MODELS OF VARIABLE WHITE RIBBONLYTE

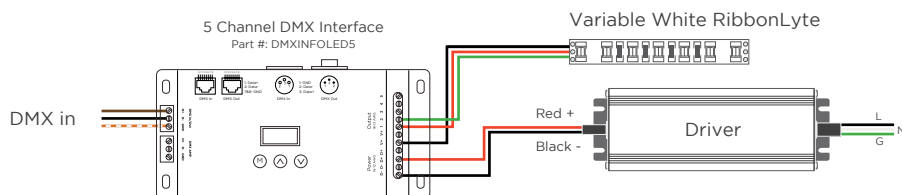

WIRE COLORS PER RIBBONLYTE COLOR

STATIC WHITE + STATIC COLOR

Red Wire (+) Positive
Black Wire (-) Negative

RGBW + RGBA

Black Wire (+) Positive
Green Wire (-) goes to Green Channel
Red Wire (-) goes to Red Channel
Blue Wire (-) goes to Blue Channel
White Wire (-) goes to White Channel

RGBWW

Black (+) Positive
Green Wire (-) goes to Green Channel
Red Wire (-) goes to Red Channel
Blue Wire (-) goes to Blue Channel
White Wire (-) goes to White Channel 1
Brown Wire (-) goes to White Channel 2

WARM DIM

Red Wire (-) goes to Warm White Channel
Blue Wire (-) goes to Cool White Channel
Black Wire (+) goes to Warm White Channel
Green Wire (+) goes to Cool White Channel

VARIABLE WHITE

Black Wire (+) Positive
Red Wire (-) goes to Warm White Channel
Green Wire (-) goes to Cool White Channel