

**AR30 CHANNEL FIXTURE**

AR30 Channel is a shallow recessed aluminum channel that offers the choice of clear, milky or black lens to create a full range of light output options. Design a custom fixture for nearly any application with AR30 Channel and our RibbonLyte products.

- Available for field assembly or factory assembly
- 1.75 in. (44.4 mm) wide by 0.55 in. (14 mm) deep
- Beam angle: 110°
- Wattage Range from 0.75 W/ft (2.46 W/m) to 12 W/ft (39.4 W/m)
- Static White delivered lumen range from 44 lm/ft (145 lm/m) up to 1273 lm/ft (4176 lm/m)
- Clear, Milky or Black lens

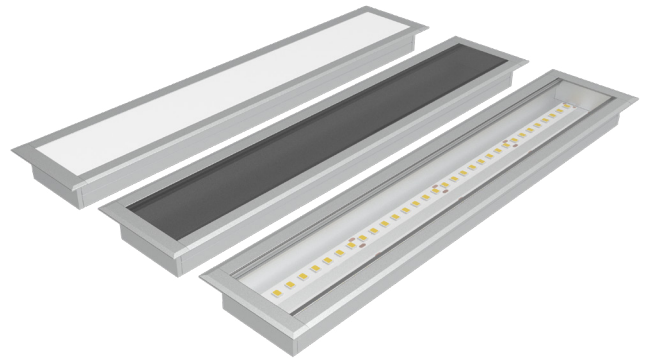

**HOUSING FINISHES**

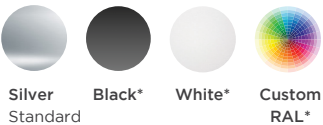

\*Additional fee applies

**LENS FINISHES**



\*\*Our black lens offers great diffusion and helps hide fixtures that aren't in use.



**AVAILABLE COLORS & COLOR TEMPERATURES**

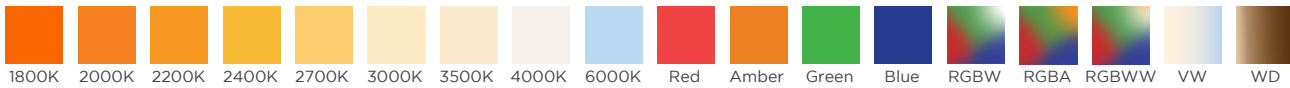

**DIMENSIONS**

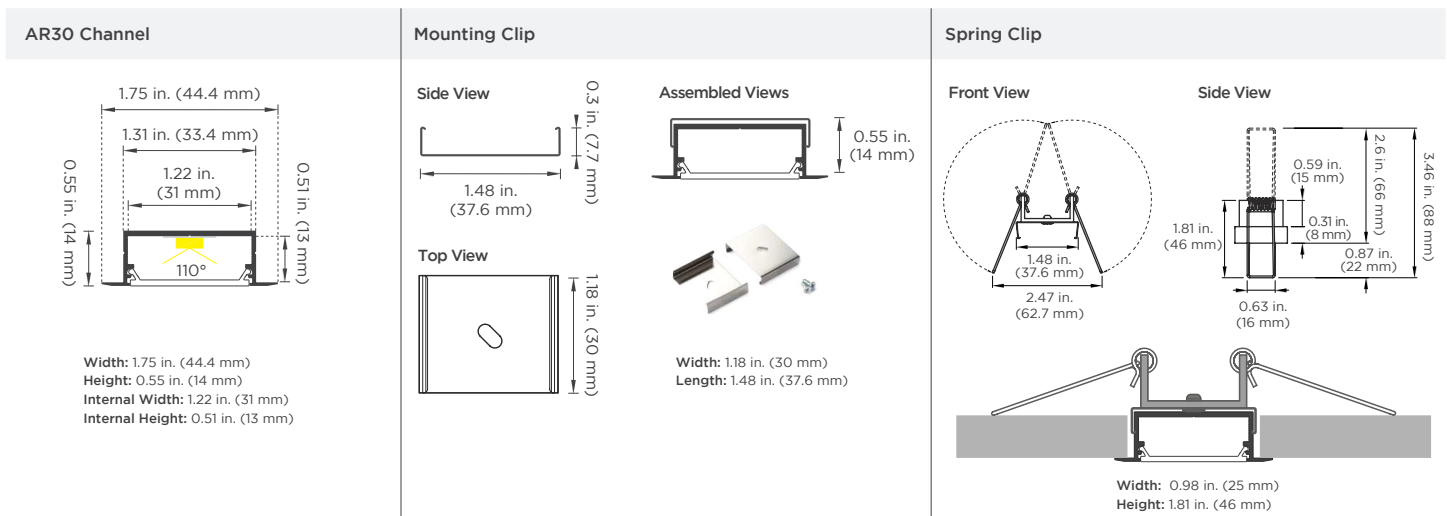

**NOTE:** Exterior channel applications should be securely attached to the mounting surface with appropriate screws and/or liquid nails. Acolyte strongly recommends field assembly for exterior applications. Use mounting clips for interior applications only.

**SPECIFICATIONS**

<b>Beam Angle</b>	110°
<b>Lens Type</b>	Clear Lens, Milky Lens, Black Lens
<b>Length</b>	Channel is sold by the foot and cut to your exact desired length. Required amount of mounting clips included.
<b>Operating Voltage</b>	24V
<b>Dimming</b>	MLV / 0-10 Volt / ELV / DALI / DMX
<b>Operating Temperature</b>	-40° F to 158° F (-40° C to 70° C)
<b>Colors</b>	1800K, 2000K, 2200K, 2400K, 2700K, 3000K, 3500K, 4000K, 6000K, Red, Amber, Green, Blue, RGBA, RGBW, RGBWW, VW, RGBW Addressable, Warm Dim (1800K, 2000K, 2200K only available in IP20)
<b>CRI</b>	90+ CRI (Static white only)
<b>Lamp Life</b>	L70 at 50,000 Hours
<b>MacAdam Ellipses (SDCM)</b>	2-Step Binning (For Static White LEDs only)
<b>Certifications</b>	UL Listed UL 2108 Issued: 2004/02/27 Ed: 1 Rev: 2014/02/24 Low Voltage Lighting Systems CSA C22.2#9.0 Issued: 1996/06/01 Ed: 1 (R2011) General Requirements for Luminaires; with Gen. Inst. 1: 1997, Gen Inst. 2: 1998. ROHS compliant

**ACCESSORIES**

End Cap

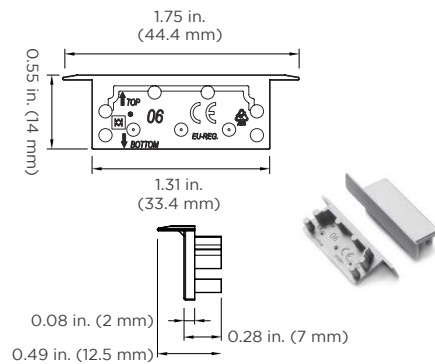

**STEP 1 Complete Channel Part Number**

CHANNEL	LENS	HOUSING COLOR	MOUNTING TYPE
<b>CHAR30</b>			
CHAR30 - AR30 Channel	C - Clear Lens M - Milky Lens BK - Black Lens	SV - Silver BK - Black WH - White Consult factory for custom colors	C - Mounting Clips S - Spring Clips

**STEP 2 Complete RibbonLyte Part Number**

CATEGORY	CRI	RIBBON TYPE & IP RATING		
<b>RB</b>				
RB - RibbonLyte	0 - Static Color, Color Changing 90 - 90+ CRI Static White	LINEA20 - Linea RibbonLyte IP20 SWS220 - Static White Series 2 IP20 SWS220 - Static White Series 2 IP20 SWS265 - Static White Series 2 IP65 SWS268 - Static White Series 2 IP68 SCS220 - Static Color Series 2 IP20 SCS265 - Static Color Series 2 IP65 SCS268 - Static Color Series 2 IP68	SWDR20 - Static White Double Row IP20 RGBWADR20 - RGBW/A Double Row IP20 VWDR20 - Variable White Double Row IP20 RGBWS220 - RGBW Series 2 IP20 RGBWS265 - RGBW Series 2 IP65 RGBWS268 - RGBW Series 2 IP68 RGBWA20 - RGBW/A IP20 RGBWA65 - RGBW/A IP65	RGBWA68 - RGBW/A IP68 VWS220 - VW Series 2 IP20 VWS265 - VW Series 2 IP65 VWS268 - VW Series 2 IP68 WD20 - Warm Dim IP20 WD65 - Warm Dim IP65 WD68 - Warm Dim IP68 RGBWADD - Addressable RGBW IP67

**NOTE:** To ensure waterproofing standards are met, IP65, IP67, and IP68 RibbonLyte can NOT be cut in the field.

**WATTAGE**

- 0.75 - 0.75 W/ft (2.46 W/m - Static White, Static Color)
- 1.0 - 1.0 W/ft (3.3 W/m - Variable White)
- 1.5 - 1.5 W/ft (4.9 W/m - Static White, Static Color)
- 2.2 - 2.2 W/ft (7.2 W/m - Static White, Static Color)
- 2.4 - 2.4 W/ft (8 W/m - Static White)
- 3.0 - 3.0 W/ft (9.8 W/m - Static White, Static Color, Variable White, RGBW, RGBA)
- 4.3 - 4.3 W/ft (14 W/m - Static White)
- 4.4 - 4.4 W/ft (14.4 W/m - Static White, Static Color, RGBW, RGBWW, RGBA)
- 5.0 - 5.0 W/ft (16.4 W/m - Static White, Static Color)
- 5.2 - 5.2 W/ft (17.1 W/m - Warm Dim)
- 5.5 - 5.5 W/ft (18.0 W/m - RGBW, RGBA)
- 6.0 - 6.0 W/ft (19.7 W/m - Static White, Static Color, Variable White, RGBW, RGBA, RGBW Addressable)
- 6.1 - 6.1 W/ft (20 W/m - Variable White)
- 8.8 - 8.8 W/ft (28.9 W/m - RGBW, RGBA, RGBWW)
- 12.0 - 12.0 W/ft (39.4 W/m - Static White, Variable White, RGBW, RGBA)

**COLOR**

- 18 - 1800K
- 20 - 2000K
- 22 - 2200K
- 24 - 2400K
- 27 - 2700K
- 30 - 3000K
- 35 - 3500K
- 40 - 4000K
- 60 - 6000K
- R - Red
- A - Amber
- G - Green
- B - Blue
- VW - Variable White
- RGB27 - Red, Green, Blue + 2700K
- RGB30 - Red, Green, Blue + 3000K
- RGB40 - Red, Green, Blue + 4000K
- RGB60 - Red, Green, Blue + 6000K
- RGB2465 - Red, Green, Blue + 2400K + 6500K
- RGBA - Red, Green, Blue + Amber
- RGBW30 - RGB + 3000K Addressable
- RGBW40 - RGB + 4000K Addressable
- RGBW60 - RGB + 6000K Addressable
- 2920 - Warm Dim 2900K - 2000K (IP20)
- 2721 - Warm Dim 2700K - 2100K (IP65+IP68)
- Z - Undecided\*\*

\*\* For quotes only. Must be chosen before final order.

**CONNECTION OPTIONS** (See diagrams on the right)

- 1 - End Feed Bare Wire Connection
- 2 - Back Feed Bare Wire Connection
- 3 - Side Feed Bare Wire Connection
- 4 - End Feed with IP67 Male Coupler
- 5 - Soldered Daisy Chain
- 6 - Daisy Chain With IP67 Couplers

**Custom Length (ft.)**

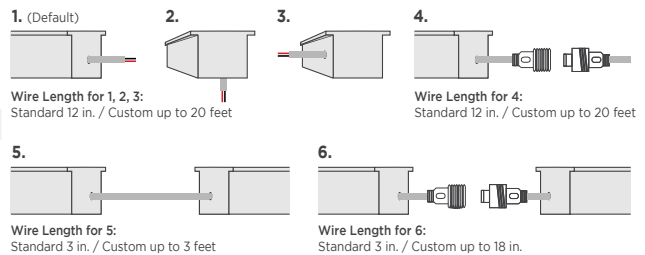

**DO NOT BUTT END CAPS AGAINST EACH OTHER WHEN CREATING LONGER FIXTURES**  
Acolyte STRONGLY SUGGESTS field assembly (without using interior end caps) for direct-view fixtures of more than 6 ft 6.7 in. (2 m) in length. Field assembly without interior end caps will eliminate gaps or dead spots that can be caused by butting interior end caps against each other.

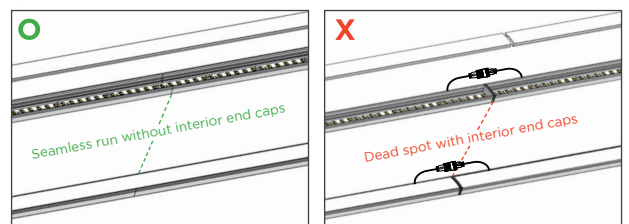

**STEP 3 Complete Assembly Option & Length**

**ASSEMBLY OPTION**      **LENGTH** (Standard factory assembled length up to 6 ft 6.7 in. / 2 m)

- FI - Field Assembly
- FA - Factory Assembly\* (not recommended for exterior applications)

\* Factory assembled runs exceeding 6 ft 6.7 in. (2 m) will be split into multiple daisy chained fixtures.

RIBBONLYTE SPECIFICATIONS & COMPATIBILITY

Available Wattage	Cuttable Length	LED Pitch	Color Temp.	lm/W without Lens	Delivered Lumens			Max Length	Compatible with Channel		
					with Clear Lens lm/ft / lm/m	with Milky Lens lm/ft / lm/m	with Black Lens lm/ft / lm/m		IP20	IP65	IP68
0.75 Static White Series 2	1.97 in. (50 mm)	48 LEDs/ft (160 LEDs/m)	1800K	84	59 / 192	47 / 155	44 / 145	IP20: 49 ft (15 m) IP65/IP68: 32.8 ft (10 m)	✓	✓	✓
			2000K	99	69 / 227	56 / 183	52 / 171				
			2200K	109	76 / 249	61 / 201	57 / 188				
			2400K	113	79 / 259	64 / 209	59 / 195				
			2700K	123	86 / 281	69 / 227	65 / 212				
			3000K	123	86 / 281	69 / 227	65 / 212				
			3500K	130	91 / 297	73 / 240	68 / 224				
			4000K	134	93 / 307	75 / 247	70 / 231				
6000K	131	91 / 300	74 / 242	69 / 226							
1.5 Static White Series 2	1.97 in. (50 mm)	48 LEDs/ft (160 LEDs/m)	1800K	84	117 / 384	95 / 310	88 / 289	IP20: 49 ft (15 m) IP65/IP68: 32.8 ft (10 m)	✓	✓	✓
			2000K	98	137 / 384	110 / 362	103 / 338				
			2200K	109	152 / 499	123 / 402	114 / 375				
			2400K	113	158 / 517	127 / 417	119 / 389				
			2700K	123	172 / 563	138 / 454	129 / 424				
			3000K	123	172 / 563	138 / 454	129 / 424				
			3500K	129	180 / 590	145 / 476	135 / 444				
			4000K	134	187 / 613	151 / 495	141 / 462				
6000K	131	183 / 600	147 / 484	138 / 451							
2.2 Static White Series 2	1.97 in. (50 mm)	48 LEDs/ft (160 LEDs/m)	1800K	83	170 / 557	137 / 449	128 / 419	IP20: 42 ft (12.8 m) IP65/IP68: 32.8 ft (10 m)	✓	✓	✓
			2000K	96	196 / 644	158 / 520	148 / 485				
			2200K	106	217 / 712	175 / 574	163 / 536				
			2400K	111	227 / 745	183 / 601	171 / 561				
			2700K	120	246 / 806	198 / 650	185 / 606				
			3000K	122	250 / 819	201 / 660	188 / 616				
			3500K	127	260 / 852	210 / 687	196 / 642				
			4000K	133	272 / 893	219 / 720	205 / 672				
6000K	128	262 / 859	211 / 693	197 / 647							
3.0 Static White Series 2	1.97 in. (50 mm)	48 LEDs/ft (160 LEDs/m)	1800K	84	234 / 769	189 / 620	176 / 579	IP20: 36 ft (11 m) IP65/IP68: 32.8 ft (10 m)	✓	✓	✓
			2000K	98	273 / 897	221 / 723	206 / 675				
			2200K	108	301 / 989	243 / 797	227 / 744				
			2400K	109.8	306 / 1005	247 / 811	231 / 756				
			2700K	122.9	343 / 1125	277 / 907	258 / 847				
			3000K	130	363 / 1190	293 / 960	273 / 896				
			3500K	133	371 / 1217	299 / 982	279 / 916				
			4000K	133	371 / 1217	299 / 982	279 / 916				
6000K	128	357 / 1172	288 / 945	269 / 882							
4.4 Static White Series 2	1.97 in. (50 mm)	48 LEDs/ft (160 LEDs/m)	1800K	81	331 / 1087	267 / 877	249 / 818	28 ft 4 in. (8.64 m)	✓	✓	✓
			2000K	95	389 / 1275	314 / 1029	293 / 960				
			2200K	105	430 / 1410	347 / 1137	323 / 1061				
			2400K	109	446 / 1463	360 / 1180	336 / 1101				
			2700K	122	499 / 1638	403 / 1321	376 / 1233				
			3000K	129	528 / 1732	426 / 1397	397 / 1304				
			3500K	132	540 / 1772	436 / 1429	407 / 1334				
			4000K	132	540 / 1772	436 / 1429	407 / 1334				
6000K	126	516 / 1692	416 / 1364	388 / 1273							
5.0 Static White Series 2	1.4 in. (35.7 mm)	68 LEDs/ft (224 LEDs/m)	1800K	83	386 / 1266	311 / 1021	291 / 953	IP20: 33 ft 4 in. (10.1 m) IP65/IP68: 32.8 ft (10 m)	✓	✓	✓
			2000K	98	456 / 1495	368 / 1206	343 / 1125				
			2200K	107	498 / 1632	401 / 1316	375 / 1229				
			2400K	110	511 / 1675	412 / 1351	384 / 1261				
			2700K	123	571 / 1875	461 / 1512	430 / 1411				
			3000K	130	605 / 1983	488 / 1599	455 / 1493				
			3500K	133	618 / 2029	499 / 1636	466 / 1527				
			4000K	133	618 / 2029	499 / 1636	466 / 1527				
6000K	127	591 / 1937	476 / 1562	445 / 1458							
6.0 Static White Series 2	1.4 in. (35.7 mm)	68 LEDs/ft (224 LEDs/m)	1800K	82	458 / 1501	369 / 1211	344 / 1130	28 ft (8.5 m)	✓	✓	✓
			2000K	95	530 / 1739	428 / 1403	399 / 1309				
			2200K	106	591 / 1941	477 / 1565	445 / 1461				
			2400K	109	608 / 1995	491 / 1609	458 / 1502				
			2700K	122	681 / 2233	549 / 1801	512 / 1681				
			3000K	129	720 / 2362	581 / 1905	542 / 1778				
			3500K	132	737 / 2417	594 / 1949	554 / 1819				
			4000K	132	737 / 2417	594 / 1949	554 / 1819				
6000K	126	703 / 2307	567 / 1860	529 / 1736							

RIBBONLYTE SPECIFICATIONS & COMPATIBILITY

Available Wattages	Cuttable Length	LED Pitch	Color Temp.	lm/W without Lens	Delivered Lumens			Max Length	Compatible with Channel		
					with Clear Lens lm/ft / lm/m	with Milky Lens lm/ft / lm/m	with Black Lens lm/ft / lm/m		IP20	IP65	IP68
3.0 Static White Double Row	0.7 in. (17.9 mm)	136 LEDs/ft (448 LEDs/m)	1800K	73	206 / 676	202 / 662	153 / 504	65 ft 7 in. (20 m)	✓	N/A	N/A
			2000K	86	243 / 798	238 / 781	181 / 595				
			2200K	94	266 / 872	260 / 853	198 / 649				
			2400K	97	273 / 896	267 / 877	203 / 667				
			2700K	109	308 / 1010	301 / 989	229 / 752				
			3000K	118	333 / 1092	326 / 1069	248 / 813				
			3500K	119	335 / 1100	328 / 1077	250 / 819				
			4000K	118	333 / 1092	326 / 1069	248 / 813				
6.0 Static White Double Row	0.7 in. (17.9 mm)	136 LEDs/ft (448 LEDs/m)	1800K	73	412 / 1353	403 / 1324	307 / 1007	39 ft (12 m)	✓	N/A	N/A
			2000K	86	487 / 1597	476 / 1563	362 / 1189				
			2200K	94	531 / 1744	520 / 1707	396 / 1298				
			2400K	97	546 / 1792	535 / 1754	407 / 1335				
			2700K	109	616 / 2021	603 / 1978	459 / 1505				
			3000K	118	666 / 2184	651 / 2137	496 / 1626				
			3500K	119	670 / 2200	656 / 2153	499 / 1638				
			4000K	118	666 / 2184	651 / 2137	496 / 1626				
12.0 Static White Double Row	0.7 in. (17.9 mm)	136 LEDs/ft (448 LEDs/m)	1800K	69	783 / 2567	766 / 2513	583 / 1912	26 ft 3 in. (8 m)	✓	N/A	N/A
			2000K	82	924 / 3031	904 / 2967	688 / 2257				
			2200K	89	1009 / 3310	987 / 3239	751 / 2465				
			2400K	92	1037 / 3403	1015 / 3330	772 / 2534				
			2700K	104	1169 / 3836	1144 / 3754	871 / 2856				
			3000K	112	1263 / 4145	1236 / 4057	941 / 3087				
			3500K	113	1273 / 4176	1246 / 4087	948 / 3110				
			4000K	112	1263 / 4145	1236 / 4057	941 / 3087				
0.75 Static Color Series 2	1.97 in. (50 mm)	48 LEDs/ft (160 LEDs/m)	Red	41	29 / 94	23 / 76	22 / 71	IP20: 49 ft (15 m) IP65/IP68: 32.8 ft (10 m)	✓	✓	✓
			Green	175	122 / 400	98 / 323	92 / 301				
			Blue	19	13.3 / 43	10.7 / 35	10 / 33				
			Amber	34	24 / 78	19 / 63	18 / 59				
1.5 Static Color Series 2	1.97 in. (50 mm)	48 LEDs/ft (160 LEDs/m)	Red	42	59 / 192	47 / 155	44 / 145	IP20: 49 ft (15 m) IP65/IP68: 32.8 ft (10 m)	✓	✓	✓
			Green	160	223 / 732	180 / 591	168 / 551				
			Blue	18	25 / 82	20 / 66	19 / 62				
			Amber	34	47 / 156	38 / 125	36 / 117				
2.2 Static Color Series 2	1.97 in. (50 mm)	48 LEDs/ft (160 LEDs/m)	Red	42	86 / 282	69 / 227	65 / 212	IP20: 42 ft (12.8 m) IP65/IP68: 32.8 ft (10 m)	✓	✓	✓
			Green	145	297 / 973	239 / 785	223 / 733				
			Blue	18	37 / 121	30 / 97	28 / 91				
			Amber	34	70 / 228	56 / 184	52 / 172				
3.0 Static Color Series 2	1.97 in. (50 mm)	48 LEDs/ft (160 LEDs/m)	Red	40	112 / 366	90 / 295	84 / 267	32.8 ft (10 m)	✓	✓	✓
			Green	127	354 / 1162	286 / 937	267 / 875				
			Blue	25	70 / 229	56 / 185	53 / 172				
			Amber	29	81 / 265	65 / 214	61 / 200				
4.4 Static Color Series 2	1.97 in. (50 mm)	48 LEDs/ft (160 LEDs/m)	Red	38	155 / 510	125 / 411	117 / 384	29 ft (8.8 m)	✓	✓	✓
			Green	117	479 / 1571	386 / 1267	360 / 1182				
			Blue	24	98 / 322	79 / 260	74 / 243				
			Amber	25	102 / 336	83 / 271	77 / 253				

RIBBONLYTE SPECIFICATIONS & COMPATIBILITY

Available Wattages	Cuttable Length	LED Pitch	Color Temp.	lm/W without Lens	Delivered Lumens			Max Length	Compatible with Channel		
					with Clear Lens lm/ft / lm/m	with Milky Lens lm/ft / lm/m	with Black Lens lm/ft / lm/m		IP20	IP65	IP68
5.0 Static Color Series 2	1.4 in. (35.7 mm)	68 LEDs/ft (224 LEDs/m)	Red	37	172 / 564	139 / 455	130 / 425	30 ft (9.14 m)	✓	✓	✓
			Green	116	539 / 1770	435 / 1427	406 / 1332				
			Blue	24	112 / 366	90 / 295	84 / 276				
			Amber	26	121 / 397	98 / 320	91 / 299				
6.0 Static Color Series 2	1.4 in. (35.7 mm)	68 LEDs/ft (224 LEDs/m)	Red	37	206 / 677	167 / 546	155 / 510	28 ft (8.5 m)	✓	✓	✓
			Green	113	631 / 2069	509 / 1668	475 / 1557				
			Blue	23	128 / 421	104 / 340	97 / 317				
			Amber	24	134 / 439	108 / 354	101 / 331				
2.4 Static White Linea	1.97 in. (50 mm)	146 LEDs/ft (480 LEDs/m)	2700K	67	149.7 / 491	120.8 / 396	112.7 / 369.6	21.3 ft (6.5 m)	✓	N/A	N/A
			3000K	71	158.1 / 519.9	127.5 / 419.3	119 / 391.3				
			3500K	83	185.1 / 608.2	149.3 / 490.5	139.3 / 457.8				
			4000K	83	185.1 / 608.2	149.3 / 490.5	139.3 / 457.8				
3.0 Static White Linea	1.97 in. (50 mm)	146 LEDs/ft (480 LEDs/m)	2700K	66	184.1 / 604.5	148.5 / 487.5	138.6 / 455	21.3 ft (6.5 m)	✓	N/A	N/A
			3000K	73	203.7 / 668.7	164.3 / 539.3	153.3 / 503.3				
			3500K	78	217.6 / 714.2	175.5 / 576	163.8 / 537.6				
			4000K	83	231.6 / 759.8	186.8 / 612.8	174.3 / 571.9				
4.3 Static White Linea	1.97 in. (50 mm)	146 LEDs/ft (480 LEDs/m)	2700K	75	300.4 / 983.9	242.3 / 793.5	226.1 / 740.6	24.6 ft (7.5 m)	✓	N/A	N/A
			3000K	78	311.6 / 023	251.3 / 825	234.5 / 770				
			3500K	86	344.1 / 129	277.5 / 910.5	259 / 849.8				
			4000K	86	344.1 / 29	277.5 / 910.5	259 / 849.8				
6.1 Variable White Linea	1.09 in. (27.78 mm)	175 LEDs/ft (576 LEDs/m)	2700K + 6500K	95	539.4 / 1769.8	435 / 427.3	406 / 332.1	16.4 ft (5 m)	✓	N/A	N/A
1.0 Variable White Series 2	1.97 in. (50 mm)	42 LEDs/ft (140 LEDs/m)	2000K + 6500K	85	79 / 259	64 / 209	60 / 195	32.8 ft (10 m)	✓	✓	✓
3.0 Variable White Series 2	1.97 in. (50 mm)	42 LEDs/ft (140 LEDs/m)	2000K + 6500K	80	223 / 732	180 / 591	168 / 551	32.8 ft (10 m)	✓	✓	✓
6.0 Variable White Series 2	1.97 in. (50 mm)	42 LEDs/ft (140 LEDs/m)	2000K + 6500K	75	419 / 1373	338 / 1107	315 / 1033	19 ft 8 in. (6 m)	✓	✓	✓
3.0 Variable White Double Row	1.97 in. (50 mm)	84 LEDs/ft (280 LEDs/m)	2000K + 6500K	87	245 / 805	240 / 788	183 / 599	65 ft 7 in. (20 m)	✓	N/A	N/A
6.0 Variable White Double Row	1.97 in. (50 mm)	84 LEDs/ft (280 LEDs/m)	2000K + 6500K	82	462 / 1517	453 / 1485	344 / 1130	45 ft 11 in. (14 m)	✓	N/A	N/A
12.0 Variable White Double Row	1.97 in. (50 mm)	84 LEDs/ft (280 LEDs/m)	2000K + 6500K	71	801 / 2628	784 / 2572	596 / 1957	22 ft 11 in. (7 m)	✓	N/A	N/A
4.4 RGBW Series 2	1.97 in. (50 mm)	36 LEDs/ft (120 LEDs/m)	RGBW	45	188.1 / 617.2	148.5 / 487.2	138.6 / 454.7	19 ft 8 in. (6 m)	✓	N/A	N/A
5.5 RGBW Series 2	1.97 in. (50 mm)	36 LEDs/ft (120 LEDs/m)	RGBW	59	308.8 / 1013	243.3 / 798.5	227.2 / 745.3	IP65: 16 ft 4 in. (5 m) IP68: 19 ft 7.9 in. (6 m)	N/A	✓	✓
8.8 RGBW Series 2	1.97 in. (50 mm)	36 LEDs/ft (120 LEDs/m)	RGBW	61	510.2 / 1673.8	402.6 / 1320.9	375.8 / 1232.9	16 ft 4 in. (5 m)	✓	N/A	N/A

**RIBBONLYTE SPECIFICATIONS & COMPATIBILITY**

Available Wattages	Cuttable Length	LED Pitch	Color Temp.	lm/W without Lens	Delivered Lumens			Max Length	Compatible with Channel		
					with Clear Lens lm/ft / lm/m	with Milky Lens lm/ft / lm/m	with Black Lens lm/ft / lm/m		IP20	IP65	IP68
3.0 RGBW Double Row	1.3 in. (33 mm)	72 LEDs/ft (240 LEDs/m)	RGBW	91	257 / 842	251 / 824	191 / 627	26 ft 3 in. (8 m)	✓	N/A	N/A
3.0 RGBA Double Row	1.3 in. (33 mm)	72 LEDs/ft (240 LEDs/m)	RGBA	78	257 / 842	251 / 824	191 / 627	26 ft 3 in. (8 m)	✓	N/A	N/A
6.0 RGBW Double Row	1.3 in. (33 mm)	72 LEDs/ft (240 LEDs/m)	RGBW	91	513 / 1684	502 / 1648	382 / 1254	22 ft 11 in. (7 m)	✓	N/A	N/A
6.0 RGBA Double Row	1.3 in. (33 mm)	72 LEDs/ft (240 LEDs/m)	RGBA	80	513 / 1684	502 / 1648	382 / 1254	22 ft 11 in. (7 m)	✓	N/A	N/A
12.0 RGBW Double Row	1.3 in. (33 mm)	72 LEDs/ft (240 LEDs/m)	RGBW	79	891 / 2924	872 / 2862	664 / 2177	14 ft 9 in. (4.5 m)	✓	N/A	N/A
12.0 RGBA Double Row	1.3 in. (33 mm)	72 LEDs/ft (240 LEDs/m)	RGBA	75	891 / 2924	872 / 2862	664 / 2177	14 ft 9 in. (4.5 m)	✓	N/A	N/A
4.4 RGBW	6.55 in. (166.4 mm)	18 LEDs/ft (60 LEDs/m)	RGBW	65	266 / 873	214.5 / 704	200.2 / 657	19 ft 7.9 in. (6 m)	✓	✓	✓
4.4 RGBA	6.55 in. (166.4 mm)	18 LEDs/ft (60 LEDs/m)	RGBA	33	135 / 443	108.9 / 357	101.6 / 333	19 ft 7.9 in. (6 m)	✓	✓	✓
5.5 4-in-1 RGBW	3.94 in. (100 mm)	18 LEDs/ft (60 LEDs/m)	RGBW	51	260.9 / 856	210.4 / 690	196.4 / 644	19 ft 7.9 in. (6 m)	✓	✓	✓
5.5 4-in-1 RGBA	3.94 in. (100 mm)	18 LEDs/ft (60 LEDs/m)	RGBA	27	138.1 / 453	111.4 / 365	104 / 341	19 ft 7.9 in. (6 m)	✓	✓	✓
8.8 RGBW	3.94 in. (100 mm)	36 LEDs/ft (120 LEDs/m)	RGBW	61	499.2 / 1638	402.6 / 1321	375.8 / 1233	19 ft 7.9 in. (6 m)	✓	✓	✓
8.8 RGBA	3.94 in. (100 mm)	36 LEDs/ft (120 LEDs/m)	RGBA	22	180.1 / 591	145.2 / 476	135.5 / 445	19 ft 7.9 in. (6 m)	✓	✓	✓
4.4 5-in-1 RGBWW	2.46 in. (62.5 mm)	29 LED/ft (96 LED/m)	RGBWW	59	241.4 / 792.1	194.7 / 638.8	181.7 / 596.2	16 ft 4 in (5 m)	✓	N/A	N/A
8.8 5-in-1 RGBWW	2.46 in. (62.5 mm)	29 LED/ft (96 LED/m)	RGBWW	50	409.2 / 1342.6	330.0 / 1082.7	308 / 1010.5	11 ft 6 in (3.5 m)	✓	N/A	N/A
RGBW Addressable	3.94 in. (100 mm)	18 LEDs/ft (60 LEDs/m)	Red	33.5	30.8 / 101.2	23.5 / 77	23.5 / 77	16 ft 5.64 in. (5.02 m)	N/A	N/A	✓ IP67
			Green	82	75.4 / 247.5	57.4 / 188.3	57.4 / 188.3				
			Blue	15.5	14.2 / 46.7	10.8 / 35.6	10.8 / 35.6				
			White	103	94.8 / 310.9	72.1 / 236.6	72.1 / 236.6				
			All	40	222.8 / 730.8	169.5 / 556.1	169.5 / 556.1				
5.2 Warm Dim	3.94 in. (100 mm)	36 LEDs/ft (120 LEDs/m)	WARM DIM	55	266 / 873	214.5 / 704	200.2 / 657	16 ft 4 in. (5 m)	✓	✓	✓

**DIODE VISIBILITY CHART** (Data below applies to installations with Milky lens only)

 <b>No Visible Diode = N</b> Note: Linea RibbonLyte has no visible diode						 <b>With Visible Diode = Y</b>														
Static White & Static Color RibbonLyte			Static White			Color Changing RibbonLyte														
0.75/1.5/2.2	3.0/4.4		5.0/6.0	3.0/6.0/12.0 Double Row	4.4 RGBW Series 2	5.5 RGBW Series 2	8.8 RGBW Series 2	3.0/6.0/12.0 RGBW/A Double Row	4.4 RGBW/A		5.5 4-in-1 RGBW/A		8.8 RGBW/A		4.4 5-in-1 RGBWW	8.8 5-in-1 RGBWW	Warm Dim	Variable White Series 2	3.0/6.0/12.0 Variable White Double Row	RGBW Addressable
IP20 IP65	IP68	IP20 IP65	IP68	IP20 IP65 IP68	IP20	IP65 IP68	IP20	IP20	IP20 IP65	IP68	IP20 IP65	IP68	IP20 IP65	IP68	IP20	IP20	IP20 IP65 IP68	IP20 IP65 IP68	IP20	IP67
Y	Y	N	Y	N	Y	Y	Y	Y	N	Y	N	Y	N	Y	Y	Y	N	N	Y	N

AVAILABLE DRIVERS / CONTROLLERS AND DIMMING OPTIONS / WIRE GAUGE CHART

NON-DIMMING ELECTRONIC DRIVERS

ELV & MLV DRIVERS



**30W, 60W, 96W**  
Non-Dimming Electronic  
Class 2 Drivers

Part No.:  
• DRVW2430 (30 Watt)  
• DRVW2460 (60 Watt)  
• DRVW2496 (96 Watt)  
Output Voltage: 24 V  
Voltage Range: 120-277 VAC  
IP Rating: Dry or Damp  
UL Listed



**240W, 320W**  
Non-Dimming  
Electronic Drivers

Part No.:  
• DRVW24240 (240 Watt)  
• DRVW24320 (320 Watt)  
Output Voltage: 24 V  
Voltage Range: 90-305 VAC  
IP Rating: Dry or Damp  
UL Recognized



**60W, 96W, 150W, 300W, 600W**  
ELV/MLV Dimmable Drivers

Part No.:  
• DRVW2460ELVMLV (60 Watt)  
• DRVW2496ELVMLV (96 Watt)  
• DRVW24150ELVMLV (150 Watt)  
• DRVW24300ELVMLV (300 Watt)  
Line Voltage Dimmable Drivers  
Output Voltage: 24 V  
Voltage Range: 100-277 VAC  
IP Rating: IP67  
UL, CE, and CSA Listed

0-10V DRIVERS



**0-10V Dimmable Waterproof Drivers**

**96W** Part No.: DRVW249610P  
**288W** Part No.: DRVW2428810P  
Output Voltage: 24 V (+/- 0.5V)  
Voltage Range: 100-277 VAC  
Environmental Rating: UL Wet Location  
UL Listed



**0-10V Dimmable 90W VW/WD Driver**

Part No.: DRVRFWDVW2490120

DMX CONTROLLER AND PART NUMBER - FOR COLOR CHANGING VERSIONS



**GLASS TOUCH**  
**WALL CONTROLLERS**  
Part Number: AWCRGBWBK  
AWCVWBK



**1 ZONE WALL CONTROLLER**  
Part Number: DMXCTRLG



**5 ZONE WALL CONTROLLER**  
Part Number: DMXCTRL



**10 ZONE WALL CONTROLLER**  
Part Number: DMXCTRLD

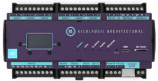

**2 UNIVERSE DMX CONTROLLER**  
Part Number: DMXCTRLDR2U



**4 CHANNEL WATERPROOF**  
**DMX INTERFACE**  
Part Number: DMXINFWLCD4



**5 CHANNEL**  
**DMX INTERFACE**  
Part Number: DMXINFOLED5



**DMX OPTO SPLITTER**  
Part Number: DMXOS8

**6 UNIVERSE DMX CONTROLLER**  
Part Number: DMXCTRLDR6U

DRIVER AND RIBBONLYTE AT FULL LOAD

Wattages	30		60		96		150		200		240		300		320		
	Wire Gauge	Feet	Meters	Feet	Meters	Feet	Meters	Feet	Meters	Feet	Meters	Feet	Meters	Feet	Meters	Feet	Meters
24 AWG / 0.25 mm <sup>2</sup>	14	4.27	9	2.74	5.5	1.68	3.75	1.14	2.75	0.84	2.25	0.69	1.75	0.53	1.75	0.53	0.53
22 AWG / 0.34 mm <sup>2</sup>	22	6.71	14	4.27	9	2.74	5.75	1.75	4.5	1.37	3.5	1.07	2.75	0.84	2.75	0.84	0.84
20 AWG / 0.5 mm <sup>2</sup>	35	10.67	23	7.01	14	4.27	9	2.74	7	2.13	5.75	1.75	4.5	1.37	4.25	1.30	1.30
18 AWG / 0.75 mm <sup>2</sup>	56	17.07	37	11.28	23	7.01	15	4.57	11	3.35	9	2.74	7.5	2.29	7	2.13	2.13
16 AWG / 1.5 mm <sup>2</sup>	90	27.44	60	18.29	37	11.28	24	7.32	18	5.49	15	4.57	12	3.66	11	3.35	3.35
14 AWG / 2.5 mm <sup>2</sup>	142	43.29	95	28.96	59	17.99	38	11.59	28	8.54	23	7.01	19	5.79	17	5.18	5.18
12 AWG / 4 mm <sup>2</sup>	226	68.90	151	46.04	94	28.66	60	18.29	45	13.72	37	11.28	30	9.15	28	8.54	8.54
10 AWG / 6 mm <sup>2</sup>	360	109.76	240	73.17	150	45.73	96	29.27	72	21.95	60	18.29	48	14.63	45	13.72	13.72
8 AWG / 10 mm <sup>2</sup>	574	175.00	381	116.16	239	72.87	153	46.65	115	35.06	95	28.96	76	23.17	71	21.65	21.65



WIRING DIAGRAMS

0-10V

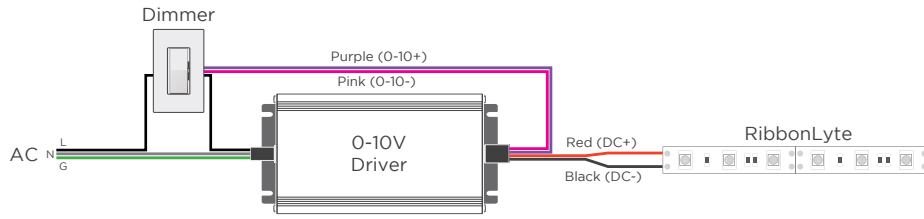

MLV / ELV

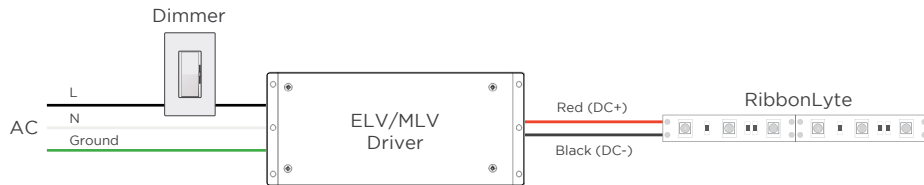

DMX

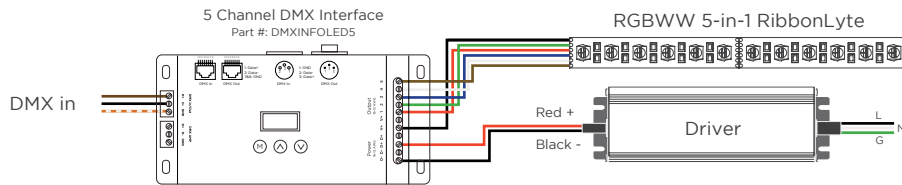

WARM DIM

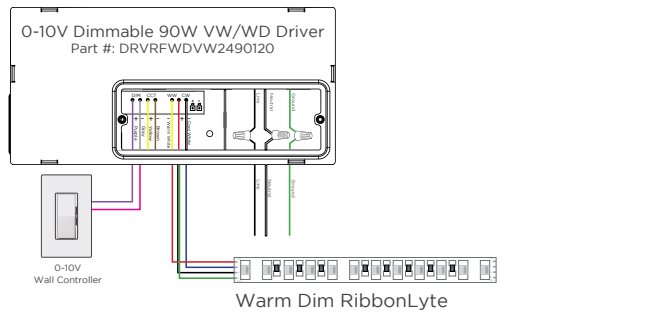

2-CHANNEL VARIABLE WHITE DIMMING

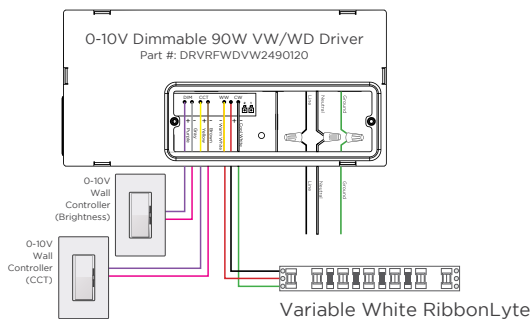

DMX WIRING DIAGRAM - COMPATIBLE WITH ALL MODELS OF VARIABLE WHITE RIBBONLYTE

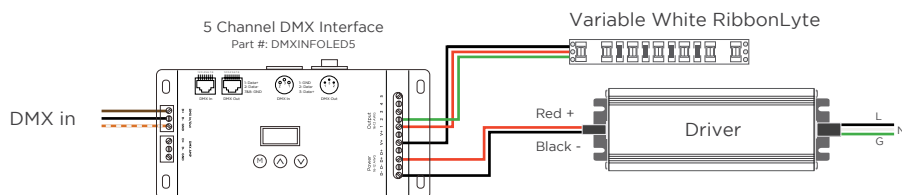

WIRE COLORS PER RIBBONLYTE COLOR

STATIC WHITE + STATIC COLOR

Red Wire (+) Positive  
Black Wire (-) Negative

RGBW + RGBA

Black Wire (+) Positive  
Green Wire (-) goes to Green Channel  
Red Wire (-) goes to Red Channel  
Blue Wire (-) goes to Blue Channel  
White Wire (-) goes to White Channel

RGBWW

Black (+) Positive  
Green Wire (-) goes to Green Channel  
Red Wire (-) goes to Red Channel  
Blue Wire (-) goes to Blue Channel  
White Wire (-) goes to White Channel 1  
Brown Wire (-) goes to White Channel 2

WARM DIM

Red Wire (-) goes to Warm White Channel  
Blue Wire (-) goes to Cool White Channel  
Black Wire (+) goes to Warm White Channel  
Green Wire (+) goes to Cool White Channel

VARIABLE WHITE

Black Wire (+) Positive  
Red Wire (-) goes to Warm White Channel  
Green Wire (-) goes to Cool White Channel

WIRING DIAGRAMS WITH RGBW ADDRESSABLE RIBBONLYTE

One DMX Universe consists of 128 addresses and 512 channels (42 ft, 8 in. of RibbonLyte).

Any single run of RibbonLyte that is less than 16 ft, 4 in. can be wired directly to the controller.

For additional runs, Opto Splitter must be used. Each individual run will need its own Opto Splitter output.

WIRE INDEX	
+	
PI	
A+	
B-	
GND	

