

AS13 CHANNEL FIXTURE

The AS13 is a shallow aluminum surface mounted channel available with round milky or square milky lens. This sleek, wide channel mounts flush to the surface. Create a custom fixture with AS13, your choice of round milky or square milky lenses and our RibbonLyte products.

- Available for field assembly or factory assembly
- 1.31 in. (33.4 mm) wide by 1.29 in. (32.7 mm) deep with round lens, 1.37 in. (34.8 mm) deep with square lens
- Beam angles: 100°x140° with Round Lens, 100°x150° with Square Lens
- Wattage Range from 0.75 W/ft (2.46 W/m) to 12 W/ft (39.4 W/m)
- Static White delivered lumen range: 47 lm/ft (155 lm/m) up to 975 lm/ft (3199 lm/m)
- Round Milky Lens or Square Milky Lens
- For interior applications only

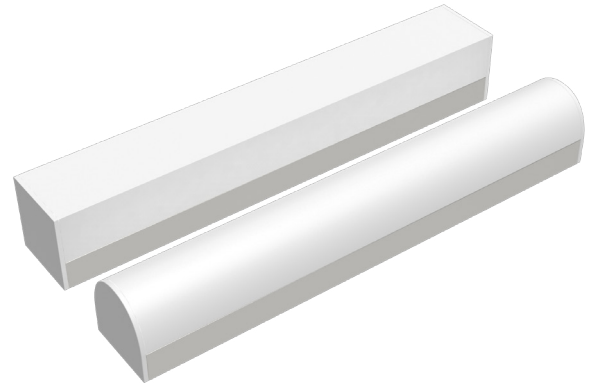

HOUSING FINISHES

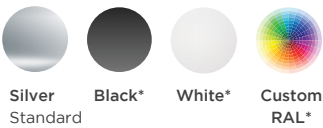

*Additional fee applies

LENS FINISHES

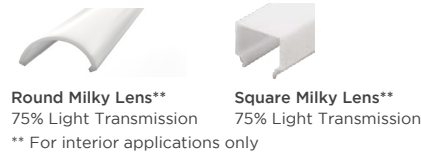

AVAILABLE COLORS & COLOR TEMPERATURES

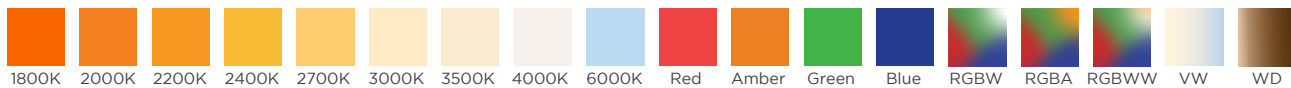

DIMENSIONS

AS13 Channel	Mounting Clip (included accessory)
<p>Width: 1.31 in. (33.4 mm) Height: 1.29 in. (32.7 mm) Internal Width: 1.22 in. (31 mm) Internal Height: 1 in. (25.3 mm)</p> <p>Width: 1.31 in. (33.4 mm) Height: 1.37 in. (34.8 mm) Internal Width: 1.22 in. (31 mm) Internal Height: 1.07 in. (27.3 mm)</p>	<p>Material: stainless steel</p> <p>Width: 0.74 in. (18.8 mm) Length: 0.87 in. (22 mm)</p>
	<p>Note:</p> <ol style="list-style-type: none"> 1. Raised lenses are for interior applications only 2. Magnetic mounting option available (see page 2)

Acolyte does not warrant or represent that the information is free from errors or omission. The information may change without notice and Acolyte is not in any way liable for the accuracy of any information printed and stored or in any way interpreted or used.

SPECIFICATIONS

Beam Angle	100x140° with Round Milky Lens, 100x150° with Square Milky Lens
Lens Type	Round Milky Lens, Square Milky Lens
Length	Channel is sold by the foot and cut to your exact desired length. Required amount of mounting clips included.
Operating Voltage	24 V
Dimming	MLV / 0-10 Volt / ELV / DALI / DMX
Operating Temperature	-40 – 158 °F (-40 – 70 °C)
Colors	1800K, 2000K, 2200K, 2400K, 2700K, 3000K, 3500K, 4000K, 6000K, Red, Amber, Green, Blue, RGBA, RGBW, RGBWW, VW, RGBW Addressable, Warm Dim (1800K, 2000K, 2200K only available in IP20)
CRI	90+ CRI (Static white only)
Lamp Life	L70 at 50,000 hours
MacAdam ellipse (SDCM)	2-Step Binning (For Static White LEDs only)
Certifications	UL Listed UL 2108 Issued: 2004/02/27 Ed: 1 Rev: 2014/02/24 Low Voltage Lighting Systems CSA C22.2#9.0 Issued: 1996/06/01 Ed: 1 (R201) General Requirements for Luminaries; with Gen. Inst. 1: 1997, Gen Inst. 2: 1998. ROHS compliant

ACCESSORIES (SEE PART NUMBERS AT STEP 4 ON PAGE 3)

End Cap (D) for channel with Round Lens	End Cap (E) for channel with Square Lens	Tiltable Stand
Material: ABS	Material: ABS	
<p>End Cap options when using channel with Round Lens or Square Lens:</p> <ol style="list-style-type: none"> Use End Cap (D) for channel with Round Lens Use End Cap (E) for channel with Square Lens 		<p>Assembled Height with channel & Round Lens: 2.15 in. (54.5 mm) Assembled Height with channel & Square Lens: 2.23 in. (56.6 mm)</p>

Magnetic Mount (Part #: CHMAGO.5)

Features:

- High-energy neodymium magnets come attached to mounting clips with countersink hex nuts
- Create easy-mount magnetic channels with minimal surface gaps; no tools or drilling necessary
- Magnets rated for 8 lbs. of pull force with static load

Applications:

- Industrial lighting retrofits for troffers and other metal fixtures
- Metal retail shelf lighting
- Temporary light fixture installations

Acolyte does not warrant or represent that the information is free from errors or omission. The information may change without notice and Acolyte is not in any way liable for the accuracy of any information printed and stored or in any way interpreted or used.

ORDERING GUIDE

STEP 1 Complete Channel Part Number

CHANNEL	LENS	HOUSING COLOR	END CAPS
CHAS13			
CHAS13 - AS13 Channel	RM - Round Milky Lens* SM - Square Milky Lens* * For interior applications only	SV - Silver (standard) BK - Black WH - White Consult factory for custom colors	D - End Cap for channel with Round Milky Lens E - End Cap for channel with Square Milky Lens

STEP 2 Complete RibbonLyte Part Number

CATEGORY	CRI	RIBBON TYPE & IP RATING		
RB				
RB - RibbonLyte	0 - Static Color, Color Changing 90 - 90+ CRI Static White	LINEA20 - Linea RibbonLyte IP20 SWS220 - Static White Series 2 IP20 SWS265 - Static White Series 2 IP65 SWS268 - Static White Series 2 IP68 SWDR20 - Static White Double Row IP20 SCS220 - Static Color Series 2 IP20 SCS265 - Static Color Series 2 IP65 SCS268 - Static Color Series 2 IP68	RGBWW20 - RGBWW 5-in-1 IP20 RGBWS220 - RGBW Series 2 IP20 RGBWS265 - RGBW Series 2 IP65 RGBWS268 - RGBW Series 2 IP68 RGBWADD - Addressable RGBW IP67 RGBWADR20 - RGBW/A Double Row IP20 VWDR20 - Variable White Double Row IP20	VWS220 - VW Series 2 IP20 VWS265 - VW Series 2 IP65 VWS268 - VW Series 2 IP68 WD20 - Warm Dim IP20 WD65 - Warm Dim IP65 WD68 - Warm Dim IP68

NOTE: To ensure waterproofing standards are met, IP65, IP67, and IP68 RibbonLyte can NOT be cut in the field.

WATTAGE

- 0.75 - 0.75 W/ft (2.46 W/m - Static White, Static Color)
- 1.0 - 1.0 W/ft (3.3 W/m - Variable White)
- 1.5 - 1.5 W/ft (4.9 W/m - Static White, Static Color)
- 2.2 - 2.2 W/ft (7.2 W/m - Static White, Static Color)
- 2.4 - 2.4 W/ft (8 W/m - Static White Linea)
- 3.0 - 3.0 W/ft (9.8 W/m - Static White, Static Color, Variable White, RGBW, RGBA)
- 4.3 - 4.3 W/ft (14 W/m - Static White Linea)
- 4.4 - 4.4 W/ft (14.4 W/m - Static White, Static Color, RGBW, RGBWW,, RGBA)
- 5.0 - 5.0 W/ft (16.4 W/m - Static White, Static Color)
- 5.2 - 5.2 W/ft (17.1 W/m - Warm Dim)
- 5.5 - 5.5 W/ft (18.0 W/m - RGBW, RGBA)
- 6.0 - 6.0 W/ft (19.7 W/m - Static White, Static Color, Variable White, RGBW, RGBA, RGBW Addressable)
- 6.1 - 6.1 W/ft (20 W/m - Variable White Linea)
- 8.8 - 8.8 W/ft (28.9 W/m - RGBW, RGBWW, RGBA)
- 12.0 - 12.0 W/ft (39.4 W/m - Static White, Variable White, RGBW, RGBA)

COLOR

- 18 - 1800K
 - 20 - 2000K
 - 22 - 2200K
 - 24 - 2400K
 - 27 - 2700K
 - 30 - 3000K
 - 35 - 3500K
 - 40 - 4000K
 - 60 - 6000K
 - R - Red
 - A - Amber
 - G - Green
 - B - Blue
 - VW - Variable White
 - RGB27 - Red, Green, Blue + 2700K
 - RGB30 - Red, Green, Blue + 3000K
 - RGB40 - Red, Green, Blue + 4000K
 - RGB2465 - Red, Green, Blue + 2400K + 6500K
 - RGBA - Red, Green, Blue + Amber
 - RGBW30 - RGB + 3000K Addressable
 - RGBW40 - RGB + 4000K Addressable
 - RGBW60 - RGB + 6000K Addressable
 - 2920 - Warm Dim 2900K - 2000K (IP20)
 - 2721 - Warm Dim 2700K - 2100K (IP65+IP68)
 - Z - Undecided**
- ** For quotes only. Must be chosen before final order.

CONNECTION OPTIONS (See diagrams on the right)

Custom Length (ft.)

- 1 - End Feed Bare Wire Connection
- 2 - Back Feed Bare Wire Connection
- 3 - End Feed with IP67 Male Coupler
- 4 - Soldered Daisy Chain
- 5 - Daisy Chain With IP67 Couplers

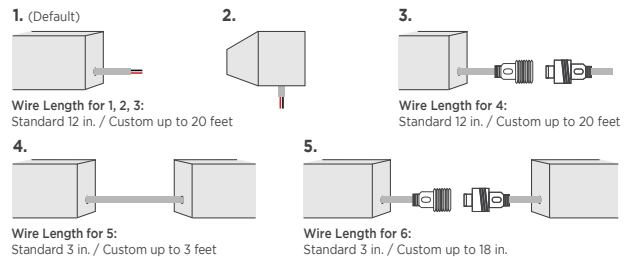

STEP 3 Complete Assembly Option & Length

ASSEMBLY OPTION LENGTH (Standard factory assembled length up to 6 ft 6.7 in. / 2 m)

- FI - Field Assembly
- FA - Factory Assembly*

* Factory assembled runs exceeding 6 ft 6.7 in. (2 m) will be split into multiple daisy chained fixtures.

STEP 4 Add Accessories

ACCESSORIES

- TILTSTANDST - Tiltable Stand
- CHMAG0.5 - Magnetic Mount

DO NOT BUTT END CAPS AGAINST EACH OTHER WHEN CREATING LONGER FIXTURES
Acolyte STRONGLY SUGGESTS field assembly (without using interior end caps) for direct-view fixtures of more than 6 ft 6.7 in. (2 m) in length. Field assembly without interior end caps will eliminate gaps or dead spots that can be caused by butting interior end caps against each other.

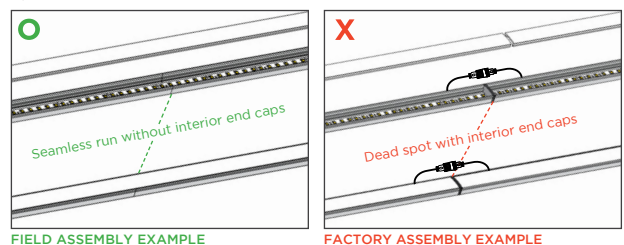

RIBBONLYTE SPECIFICATIONS & COMPATIBILITY

Available Wattage	Cuttable Length	LED Pitch	Color Temp.	lm/W without Lens	Delivered Lumens with Round Milky Lens (lm/ft / lm/m)	Delivered Lumens with Square Milky Lens (lm/ft / lm/m)	Max Length	Compatible with Channel		
								IP20	IP65	IP68
0.75 Static White Series 2	1.97 in. (50 mm)	48 LEDs/ft (160 LEDs/m)	1800K	84	47 / 155	47 / 155	IP20: 49 ft (15 m) IP65/IP68: 32.8 ft (10 m)	✓	✓	✓
			2000K	99	56 / 183	56 / 183				
			2200K	109	61 / 201	61 / 201				
			2400K	113	64 / 209	64 / 209				
			2700K	123	69 / 227	69 / 227				
			3000K	123	69 / 227	69 / 227				
			3500K	130	73 / 240	73 / 240				
			4000K	134	75 / 247	75 / 247				
			6000K	131	74 / 242	74 / 242				
1.5 Static White Series 2	1.97 in. (50 mm)	48 LEDs/ft (160 LEDs/m)	1800K	84	95 / 310	95 / 310	IP20: 49 ft (15 m) IP65/IP68: 32.8 ft (10 m)	✓	✓	✓
			2000K	98	110 / 362	110 / 362				
			2200K	109	123 / 402	123 / 402				
			2400K	113	127 / 417	127 / 417				
			2700K	123	138 / 454	138 / 454				
			3000K	123	138 / 454	138 / 454				
			3500K	129	145 / 476	145 / 476				
			4000K	134	151 / 495	151 / 495				
			6000K	131	147 / 484	147 / 484				
2.2 Static White Series 2	1.97 in. (50 mm)	48 LEDs/ft (160 LEDs/m)	1800K	83	137 / 449	137 / 449	IP20: 42 ft (12.8 m) IP65/IP68: 32.8 ft (10 m)	✓	✓	✓
			2000K	96	158 / 520	158 / 520				
			2200K	106	175 / 574	175 / 574				
			2400K	111	183 / 601	183 / 601				
			2700K	120	198 / 650	198 / 650				
			3000K	122	201 / 660	201 / 660				
			3500K	127	210 / 687	210 / 687				
			4000K	133	219 / 720	219 / 720				
			6000K	128	211 / 693	211 / 693				
3.0 Static White Series 2	1.97 in. (50 mm)	48 LEDs/ft (160 LEDs/m)	1800K	84	189 / 620	189 / 620	IP20: 36 ft (11 m) IP65/IP68: 32.8 ft (10 m)	✓	✓	✓
			2000K	98	221 / 723	221 / 723				
			2200K	108	243 / 797	243 / 797				
			2400K	109.8	247 / 811	247 / 811				
			2700K	122.9	277 / 907	277 / 907				
			3000K	130	293 / 960	293 / 960				
			3500K	133	299 / 982	299 / 982				
			4000K	133	299 / 982	299 / 982				
			6000K	128	288 / 945	288 / 945				
4.4 Static White Series 2	1.97 in. (50 mm)	48 LEDs/ft (160 LEDs/m)	1800K	81	267 / 877	267 / 877	28 ft 4 in. (8.64 m)	✓	✓	✓
			2000K	95	314 / 1029	314 / 1029				
			2200K	105	347 / 1137	347 / 1137				
			2400K	109	360 / 1180	360 / 1180				
			2700K	122	403 / 1321	403 / 1321				
			3000K	129	426 / 1397	426 / 1397				
			3500K	132	436 / 1429	436 / 1429				
			4000K	132	436 / 1429	436 / 1429				
			6000K	126	416 / 1364	416 / 1364				
5.0 Static White Series 2	1.4 in. (35.7 mm)	68 LEDs/ft (224 LEDs/m)	1800K	83	311 / 1021	311 / 1021	IP20: 33 ft 4 in. (10.1 m) IP65/IP68: 32.8 ft (10 m)	✓	✓	✓
			2000K	98	368 / 1206	368 / 1206				
			2200K	107	401 / 1316	401 / 1316				
			2400K	110	412 / 1351	412 / 1351				
			2700K	123	461 / 1512	461 / 1512				
			3000K	130	488 / 1599	488 / 1599				
			3500K	133	499 / 1636	499 / 1636				
			4000K	133	499 / 1636	499 / 1636				
			6000K	127	476 / 1562	476 / 1562				
6.0 Static White Series 2	1.4 in. (35.7 mm)	68 LEDs/ft (224 LEDs/m)	1800K	82	369 / 1211	369 / 1211	28 ft (8.5 m)	✓	✓	✓
			2000K	95	428 / 1403	428 / 1403				
			2200K	106	477 / 1565	477 / 1565				
			2400K	109	491 / 1609	491 / 1609				
			2700K	122	549 / 1801	549 / 1801				
			3000K	129	581 / 1905	581 / 1905				
			3500K	132	594 / 1949	594 / 1949				
			4000K	132	594 / 1949	594 / 1949				
			6000K	126	567 / 1860	567 / 1860				

RIBBONLYTE SPECIFICATIONS & COMPATIBILITY

Available Wattages	Cuttable Length	LED Pitch	Color Temp.	lm/W without Lens	Delivered Lumens with Round Milky Lens (lm/ft / lm/m)	Delivered Lumens with Square Milky Lens (lm/ft / lm/m)	Max Length	Compatible with Channel		
								IP20	IP65	IP68
3.0 Static White Double Row	0.7 in. (17.9 mm)	136 LEDs/ft (448 LEDs/m)	1800K	73	158 / 518	158 / 518	65 ft 7 in. (20 m)	✓	N/A	N/A
			2000K	86	186 / 612	186 / 612				
			2200K	94	204 / 668	204 / 668				
			2400K	97	209 / 686	209 / 686				
			2700K	109	236 / 774	236 / 774				
			3000K	118	255 / 836	255 / 836				
			3500K	119	257 / 843	257 / 843				
			4000K	118	255 / 836	255 / 836				
			6000K	114	247 / 811	247 / 811				
6.0 Static White Double Row	0.7 in. (17.9 mm)	136 LEDs/ft (448 LEDs/m)	1800K	73	316 / 1036	316 / 1036	39 ft (12 m)	✓	N/A	N/A
			2000K	86	373 / 1223	373 / 1223				
			2200K	94	407 / 1336	407 / 1336				
			2400K	97	418 / 1373	418 / 1373				
			2700K	109	472 / 1548	472 / 1548				
			3000K	118	510 / 1673	510 / 1673				
			3500K	119	514 / 1685	514 / 1685				
			4000K	118	510 / 1673	510 / 1673				
			6000K	114	495 / 1623	495 / 1623				
12.0 Static White Double Row	0.7 in. (17.9 mm)	136 LEDs/ft (448 LEDs/m)	1800K	69	599 / 1967	599 / 1967	26 ft 3 in. (8 m)	✓	N/A	N/A
			2000K	82	708 / 2322	708 / 2322				
			2200K	89	773 / 2535	773 / 2535				
			2400K	92	794 / 2606	794 / 2606				
			2700K	104	895 / 2938	895 / 2938				
			3000K	112	968 / 3175	968 / 3175				
			3500K	113	975 / 3199	975 / 3199				
			4000K	112	968 / 3175	968 / 3175				
			6000K	109	939 / 3080	939 / 3080				
0.75 Static Color Series 2	1.97 in. (50 mm)	48 LEDs/ft (160 LEDs/m)	Red	41	23 / 76	23 / 76	IP20: 49 ft (15 m) IP65/ IP68: 32.8 ft (10 m)	✓	✓	✓
			Green	175	98 / 323	98 / 323				
			Blue	19	11 / 35	11 / 35				
			Amber	34	19 / 63	19 / 63				
1.5 Static Color Series 2	1.97 in. (50 mm)	48 LEDs/ft (160 LEDs/m)	Red	42	47 / 155	47 / 155	IP20: 49 ft (15 m) IP65/ IP68: 32.8 ft (10 m)	✓	✓	✓
			Green	160	180 / 591	180 / 591				
			Blue	18	20 / 66	20 / 66				
			Amber	34	38 / 125	38 / 125				
2.2 Static Color Series 2	1.97 in. (50 mm)	48 LEDs/ft (160 LEDs/m)	Red	42	69 / 227	69 / 227	IP20: 42 ft (12.8 m) IP65/ IP68: 32.8 ft (10 m)	✓	✓	✓
			Green	145	239 / 785	239 / 785				
			Blue	18	30 / 97	30 / 97				
			Amber	34	56 / 184	56 / 184				
3.0 Static Color Series 2	1.97 in. (50 mm)	48 LEDs/ft (160 LEDs/m)	Red	40	90 / 295	90 / 295	32.8 ft (10 m)	✓	✓	✓
			Green	127	286 / 937	286 / 937				
			Blue	25	56 / 185	56 / 185				
			Amber	29	65 / 214	65 / 214				
4.4 Static Color Series 2	1.97 in. (50 mm)	48 LEDs/ft (160 LEDs/m)	Red	38	125 / 411	125 / 411	29 ft (8.8 m)	✓	✓	✓
			Green	117	386 / 1267	386 / 1267				
			Blue	24	79 / 260	79 / 260				
			Amber	25	83 / 271	83 / 271				

RIBBONLYTE SPECIFICATIONS & COMPATIBILITY

Available Wattages	Cuttable Length	LED Pitch	Color Temp.	lm/W without Lens	Delivered Lumens with Round Milky Lens (lm/ft / lm/m)	Delivered Lumens with Square Milky Lens (lm/ft / lm/m)	Max Length	Compatible with Channel		
								IP20	IP65	IP68
5.0 Static Color Series 2	1.4 in. (35.7 mm)	68 LEDs/ft (224 LEDs/m)	Red	37	139 / 455	139 / 455	30 ft (9.14 m)	✓	✓	✓
			Green	116	435 / 1427	435 / 1427				
			Blue	24	90 / 295	90 / 295				
			Amber	26	98 / 320	98 / 320				
6.0 Static Color Series 2	1.4 in. (35.7 mm)	68 LEDs/ft (224 LEDs/m)	Red	37	167 / 546	167 / 546	28 ft (8.5 m)	✓	✓	✓
			Green	113	509 / 1668	509 / 1668				
			Blue	23	104 / 340	104 / 340				
			Amber	24	108 / 354	108 / 354				
2.4 Static White Linea	1.97 in. (50 mm)	146 LEDs/ft (480 LEDs/m)	2700K	67	120.8 / 396	120.8 / 396	21.3 ft (6.5 m)	✓	N/A	N/A
			3000K	71	127.5 / 419.3	127.5 / 419.3				
			3500K	83	149.3 / 490.5	149.3 / 490.5				
			4000K	83	149.3 / 490.5	149.3 / 490.5				
3.0 Static White Linea	1.97 in. (50 mm)	146 LEDs/ft (480 LEDs/m)	2700K	66	148.5 / 487.5	148.5 / 487.5	21.3 ft (6.5 m)	✓	N/A	N/A
			3000K	73	164.3 / 539.3	164.3 / 539.3				
			3500K	78	175.5 / 576	175.5 / 576				
			4000K	83	186.8 / 612.8	186.8 / 612.8				
4.3 Static White Linea	1.97 in. (50 mm)	146 LEDs/ft (480 LEDs/m)	2700K	75	242.3 / 793.5	242.3 / 793.5	24.6 ft (7.5 m)	✓	N/A	N/A
			3000K	78	251.3 / 825	251.3 / 825				
			3500K	86	277.5 / 910.5	277.5 / 910.5				
			4000K	86	277.5 / 910.5	277.5 / 910.5				
6.1 Variable White Linea	1.09 in. (27.78 mm)	175 LEDs/ft (576 LEDs/m)	2700K + 6500K	95	435 / 1427.3	435 / 1427.3	16.4 ft (5 m)	✓	N/A	N/A
1.0 Variable White Series 2	1.97 in. (50 mm)	42 LEDs/ft (140 LEDs/m)	2000K + 6500K	85	64 / 209	64 / 209	32.8 ft (10 m)	✓	✓	✓
3.0 Variable White Series 2	1.97 in. (50 mm)	42 LEDs/ft (140 LEDs/m)	2000K + 6500K	80	180 / 591	180 / 591	32.8 ft (10 m)	✓	✓	✓
6.0 Variable White Series 2	1.97 in. (50 mm)	42 LEDs/ft (140 LEDs/m)	2000K + 6500K	75	337.5 / 1107	337.5 / 1107	19 ft 8 in. (6 m)	✓	✓	✓
3.0 Variable White Double Row	1.97 in. (50 mm)	84 LEDs/ft (280 LEDs/m)	2000K + 6500K	87	188 / 617	188 / 617	65 ft 7 in. (20 m)	✓	N/A	N/A
6.0 Variable White Double Row	1.97 in. (50 mm)	84 LEDs/ft (280 LEDs/m)	2000K + 6500K	82	354 / 1162	354 / 1162	45 ft 11 in. (14 m)	✓	N/A	N/A
12.0 Variable White Double Row	1.97 in. (50 mm)	84 LEDs/ft (280 LEDs/m)	2000K + 6500K	71	613 / 2013	613 / 2013	22 ft 11 in. (7 m)	✓	N/A	N/A

RIBBONLYTE SPECIFICATIONS & COMPATIBILITY

Available Wattages	Cuttable Length	LED Pitch	Color Temp.	lm/W without Lens	Delivered Lumens with Round Milky Lens (lm/ft / lm/m)	Delivered Lumens with Square Milky Lens (lm/ft / lm/m)	Max Length	Compatible with Channel		
								IP20	IP65	IP68
4.4 RGBW Series 2	1.97 in. (50 mm)	36 LEDs/ft (120 LEDs/m)	RGBW	45	138.6 / 454.7	138.6 / 454.7	19 ft 8 in. (6 m)	✓	N/A	N/A
5.5 RGBW Series 2	1.97 in. (50 mm)	36 LEDs/ft (120 LEDs/m)	RGBW	59	272.2 / 745.3	272.2 / 745.3	IP65: 16 ft 4 in. (5 m) IP68: 19 ft 7.9 in. (6 m)	N/A	✓	✓
8.8 RGBW Series 2	1.97 in. (50 mm)	36 LEDs/ft (120 LEDs/m)	RGBW	61	375.8 / 1232.9	375.8 / 1232.9	16 ft 4 in. (5 m)	✓	N/A	N/A
3.0 RGBW Double Row	1.3 in. (33 mm)	72 LEDs/ft (240 LEDs/m)	RGBW	91	205 / 672	205 / 672	26 ft 3 in. (8 m)	✓	N/A	N/A
3.0 RGBA Double Row	1.3 in. (33 mm)	72 LEDs/ft (240 LEDs/m)	RGBA	78	205 / 672	205 / 672	26 ft 3 in. (8 m)	✓	N/A	N/A
6.0 RGBW Double Row	1.3 in. (33 mm)	72 LEDs/ft (240 LEDs/m)	RGBW	91	410 / 1344	410 / 1344	22 ft 11 in. (7 m)	✓	N/A	N/A
6.0 RGBA Double Row	1.3 in. (33 mm)	72 LEDs/ft (240 LEDs/m)	RGBA	80	410 / 1344	410 / 1344	22 ft 11 in. (7 m)	✓	N/A	N/A
12.0 RGBW Double Row	1.3 in. (33 mm)	72 LEDs/ft (240 LEDs/m)	RGBW	79	711 / 2333	711 / 2333	14 ft 9 in. (4.5 m)	✓	N/A	N/A
12.0 RGBA Double Row	1.3 in. (33 mm)	72 LEDs/ft (240 LEDs/m)	RGBA	75	711 / 2333	711 / 2333	14 ft 9 in. (4.5 m)	✓	N/A	N/A
4.4 5-in-1 RGBWW	2.46 in. (62.5 mm)	29 LED/ft (96 LED/m)	RGBWW	59	181.7 / 596.2	181.7 / 596.2	16 ft 4 in (5 m)	✓	N/A	N/A
8.8 5-in-1 RGBWW	2.46 in. (62.5 mm)	29 LED/ft (96 LED/m)	RGBWW	50	308.0 / 1010.5	308 / 1010.5	11 ft 6 in (3.5 m)	✓	N/A	N/A
RGBW Addressable	3.94 in. (100 mm)	18 LEDs/ft (60 LEDs/m)	Red	33.5	25.1 / 82.5	25.1 / 82.5	16 ft 5.64 in. (5.02 m)	N/A	N/A	✓ IP67
			Green	82	61.5 / 201.8	61.5 / 201.8				
			Blue	15.5	11.6 / 38.1	11.6 / 38.1				
			White	103	77.3 / 253.5	77.3 / 253.5				
			All	40	181.6 / 595.8	181.6 / 595.8				
5.2 Warm Dim	3.94 in. (100 mm)	36 LEDs/ft (120 LEDs/m)	WARM DIM	55	215 / 704	215 / 704	16 ft 4 in. (5 m)	✓	✓	✓

DIODE VISIBILITY CHART (Data below applies to installations with Milky lens only)

No Visible Diode = N Note: Linea RibbonLyte has no visible diode				With Visible Diode = Y								
Static White & Static Color RibbonLyte			Static White	Color Changing RibbonLyte								
0.75/1.5/2.2	3.0/4.4	5.0/6.0	3.0/6.0/12.0 Double Row	4.4 RGBW Series 2	5.5 RGBW Series 2	8.8 RGBW Series 2	3.0/6.0/12.0 RGBW/A Double Row	4.4/8.8 5-in-1 RGBWW	Warm Dim	Variable White Series 2	3.0/6.0/12.0 Variable White Double Row	RGBW Addressable
IP20 IP65 IP68	IP20 IP65 IP68	IP20 IP65 IP68	IP20	IP20	IP65 IP68	IP20	IP20	IP20	IP20 IP65 IP68	IP20 IP65 IP68	IP20	IP67
N	N	N	N	N	N	N	N	N	N	N	N	N

AVAILABLE DRIVERS / CONTROLLERS AND DIMMING OPTIONS / WIRE GAUGE CHART

NON-DIMMING ELECTRONIC DRIVERS ELV & MLV DRIVERS DIMMABLE DALI DRIVERS



30W, 60W, 96W Non-Dimming Electronic Class 2 Drivers

Part No.:
• DRVW2430 (30 Watt)
• DRVW2460 (60 Watt)
• DRVW2496 (96 Watt)
Output Voltage: 24 VDC
Input Voltage: 120-277 VAC
IP65, dry/damp location
UL Listed



240W, 320W Non-Dimming Electronic Drivers

Part No.:
• DRVW24240 (240 Watt)
• DRVW24320 (320 Watt)
Output Voltage: 24 VDC
Input Voltage: 90-305 VAC
IP65, dry/damp location
UL Recognized



60W, 96W Non-Dimming Compact Drivers

Part No.:
• DRV2460C (60 Watt)
• DRV2496C (96 Watt)
Output Voltage: 24 VDC
Input Voltage: 120-277 VAC
IP20, dry location
UL Class P



60W, 96W, 150W, 300W ELV/MLV Dimmable Drivers

Part No.:
• DRVW2460ELVMLV (60 Watt)
• DRVW2496ELVMLV (96 Watt)
• DRVW24150ELVMLV (150 Watt)
• DRVW24300ELVMLV (300 Watt)
Line Voltage Dimmable Drivers
Output Voltage: 24 VDC
Input Voltage: 100-277 VAC
IP67, damp/wet location
UL, CE, and CSA Listed



100W 1 Channel, 100W 2 Channel, 150W 4 Channel Dimmable DALI Drivers

Part No.:
• DRV100DALI1CH (100W 1 channel)
• DRV100DALI2CH (100W 2 channel)
• DRV150DALI4CH (150W 4 channel)
Output Voltage: 24 VDC
Input Voltage: 120-277 VAC
IP20, dry location
CE, UL Recognized, FCC, RoHS, SELV

0-10V DRIVERS



0-10V Dimmable Waterproof Drivers

• Part No.: DRVW249610P (96 Watt)
• Part No.: DRVW2428810P (288 Watt)
Output Voltage: 24 VDC (+/- 0.5 V)
Input Voltage: 100-277 VAC
UL wet location
UL Listed



0-10V Dimmable 90W VW/WD Driver

• Part No.: DRVRFWDVW2490120
Output Voltage: 24 VDC
Input Voltage: 100-277 VAC
IP23, dry/damp location
UL Listed

ATHENA WIRELESS COMPATIBLE



94W Athena Wireless Compatible Drivers

• Part No.: DRVW2494ATH1CH (1 channel)
• Part No.: DRVW2494ATH2CH (2 channel)
Output Voltage: 24 VDC
Input Voltage: 100-277 VAC
Dry location
UL Listed

DIMMABLE DALI-2 DRIVERS



96W DIMMABLE DALI-2 DT6 D4I & DALI-2 DT8 D4I DRIVERS

• Part No.: DRVW2496DALI1CH (1 channel)
• Part No.: DRVW2496DALI2CH (2 channel)
Output Voltage: 24-26 VDC
Input Voltage: 120-277 VAC
IP67, wet location
UL Listed

DMX CONTROLLERS, VARIABLE WHITE DIMMER, WARM DIM DIMMER - FOR COLOR CHANGING FIXTURES



GLASS TOUCH WALL CONTROLLERS
Part No.: AWCRGBWWBK
AWCVWBK



1 ZONE WALL CONTROLLER
Part No.: DMXCTRLG



5 ZONE WALL CONTROLLER
Part No.: DMXCTRL



10 ZONE WALL CONTROLLER
Part No.: DMXCTRLD



6 UNIVERSE DMX CONTROLLER
Part No.: DMXCTRLDR6U



VARIABLE WHITE DIMMER
Part No.: RFDIMVWWH (White)
RFDIMVWBK (Black)



WARM DIM DIMMER
Part No.: RFDIMWDWH (White)
RFDIMWDBK (Black)



4 CHANNEL WATERPROOF DMX INTERFACE
Part No.: DMXINFWLCD4



5 CHANNEL DMX INTERFACE
Part No.: DMXINFOLED5



DMX OPTO SPLITTER
Part No.: DMXOS8

DRIVER AND RIBBONLYTE AT FULL LOAD

Wattages	30		60		96		150		200		240		300		320	
	Feet	Meters	Feet	Meters	Feet	Meters	Feet	Meters	Feet	Meters	Feet	Meters	Feet	Meters	Feet	Meters
24 AWG / 0.25 mm ²	14	4.27	9	2.74	5.5	1.68	3.75	1.14	2.75	0.84	2.25	0.69	1.75	0.53	1.75	0.53
22 AWG / 0.34 mm ²	22	6.71	14	4.27	9	2.74	5.75	1.75	4.5	1.37	3.5	1.07	2.75	0.84	2.75	0.84
20 AWG / 0.5 mm ²	35	10.67	23	7.01	14	4.27	9	2.74	7	2.13	5.75	1.75	4.5	1.37	4.25	1.30
18 AWG / 0.75 mm ²	56	17.07	37	11.28	23	7.01	15	4.57	11	3.35	9	2.74	7.5	2.29	7	2.13
16 AWG / 1.5 mm ²	90	27.44	60	18.29	37	11.28	24	7.32	18	5.49	15	4.57	12	3.66	11	3.35
14 AWG / 2.5 mm ²	142	43.29	95	28.96	59	17.99	38	11.59	28	8.54	23	7.01	19	5.79	17	5.18
12 AWG / 4 mm ²	226	68.90	151	46.04	94	28.66	60	18.29	45	13.72	37	11.28	30	9.15	28	8.54
10 AWG / 6 mm ²	360	109.76	240	73.17	150	45.73	96	29.27	72	21.95	60	18.29	48	14.63	45	13.72
8 AWG / 10 mm ²	574	175.00	381	116.16	239	72.87	153	46.65	115	35.06	95	28.96	76	23.17	71	21.65

WIRING DIAGRAMS - STATIC WHITE / STATIC COLOR / RGBW / RGBA / RGBWW

0-10 V

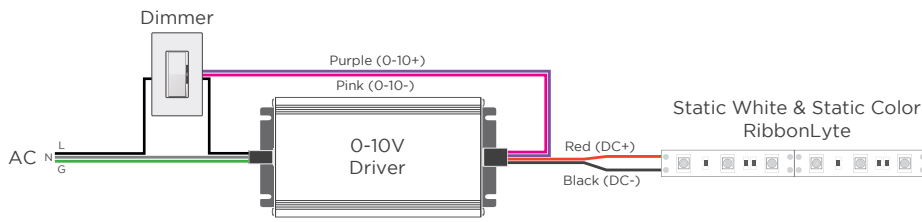

MLV / ELV

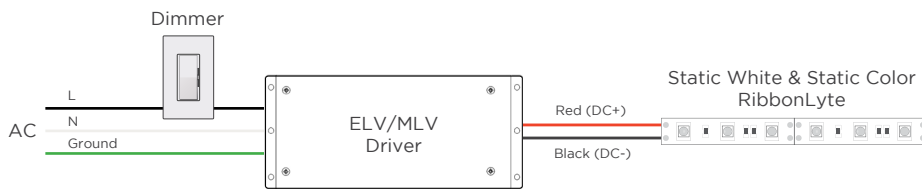

DMX WIRING WITH STATIC WHITE & STATIC COLOR RIBBONLYTE

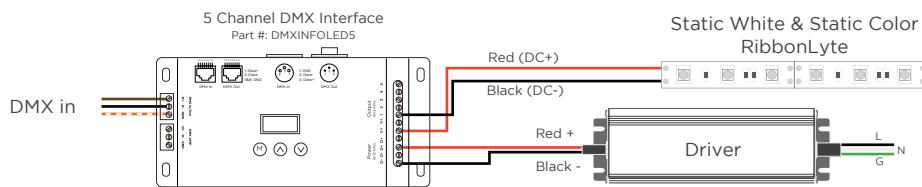

DALI-2 WIRING WITH STATIC WHITE & STATIC COLOR RIBBONLYTE

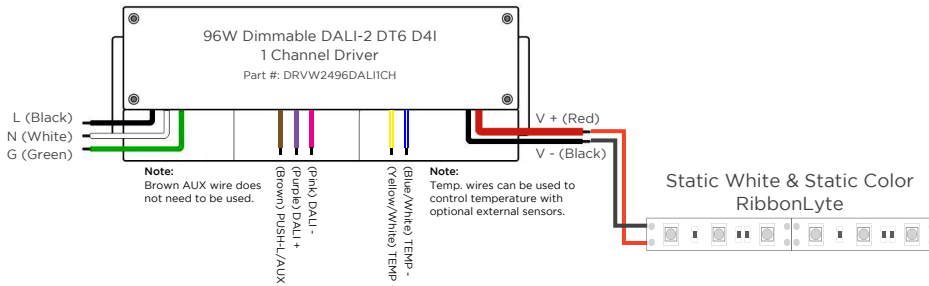

STATIC WHITE & STATIC COLOR RIBBONLYTE WIRING WITH ATHENA WIRELESS COMPATIBLE DRIVER

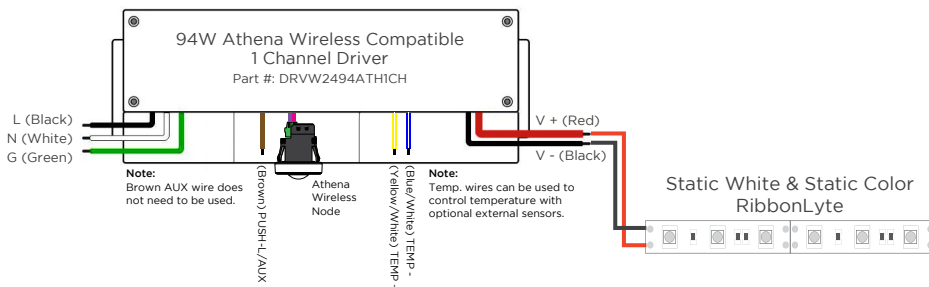

DMX WITH RGBWW 5-IN-1 RIBBONLYTE

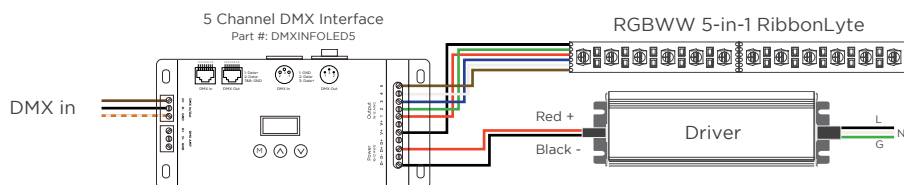

WIRE COLORS PER RIBBONLYTE COLOR

STATIC WHITE + STATIC COLOR

Red Wire (+) Positive
Black Wire (-) Negative

RGBW + RGBA

Black Wire (+) Positive
Green Wire (-) goes to Green Channel
Red Wire (-) goes to Red Channel
Blue Wire (-) goes to Blue Channel
White Wire (-) goes to White Channel

RGBWW

Black (+) Positive
Green Wire (-) goes to Green Channel
Red Wire (-) goes to Red Channel
Blue Wire (-) goes to Blue Channel
White Wire (-) goes to White Channel 1
Brown Wire (-) goes to White Channel 2

WIRING DIAGRAMS - VARIABLE WHITE

2-CHANNEL VARIABLE WHITE DIMMING

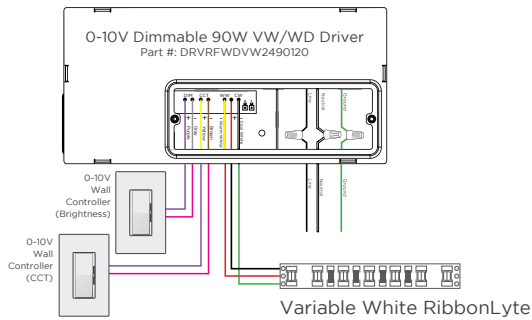

WIRE COLORS PER RIBBONLYTE COLOR

VARIABLE WHITE
Black Wire (+) Positive
Red Wire (-) goes to Warm White Channel
Green Wire (-) goes to Cool White Channel

DMX WIRING WITH VARIABLE WHITE RIBBONLYTE

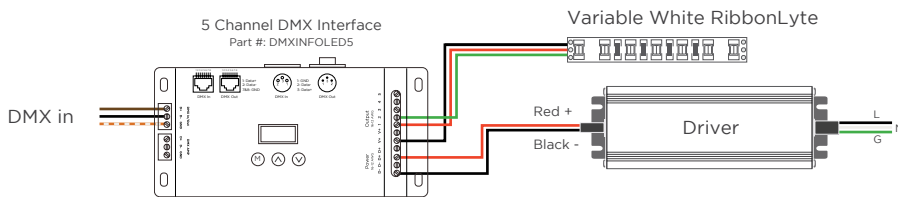

DALI-2 WIRING WITH VARIABLE WHITE RIBBONLYTE

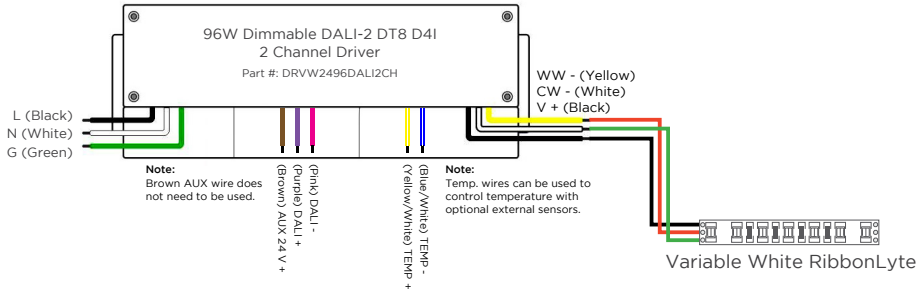

VARIABLE WHITE RIBBONLYTE WIRING WITH ATHENA WIRELESS COMPATIBLE DRIVER

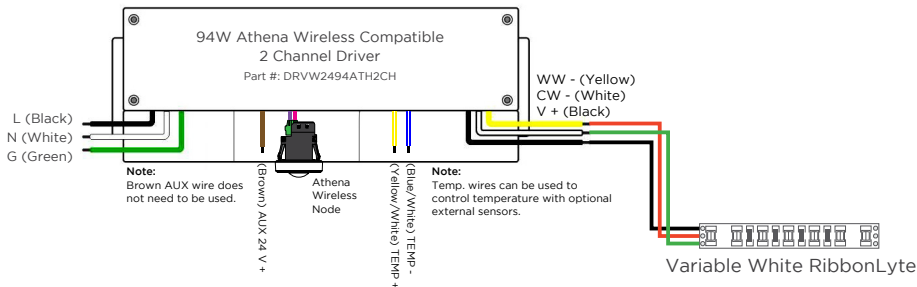

WIRING DIAGRAMS WITH RGBW ADDRESSABLE RIBBONLYTE

One DMX Universe consists of 128 addresses and 512 channels (42 ft, 8 in. of RibbonLyte).

Any single run of RibbonLyte that is less than 16 ft, 4 in. can be wired directly to the controller.

For additional runs, Opto Splitter must be used. Each individual run will need its own Opto Splitter output.

WIRE INDEX	
+	(24V +)
PI	(DMX GND)
A+	(DMX +)
B-	(DMX -)
GND	(24V -)

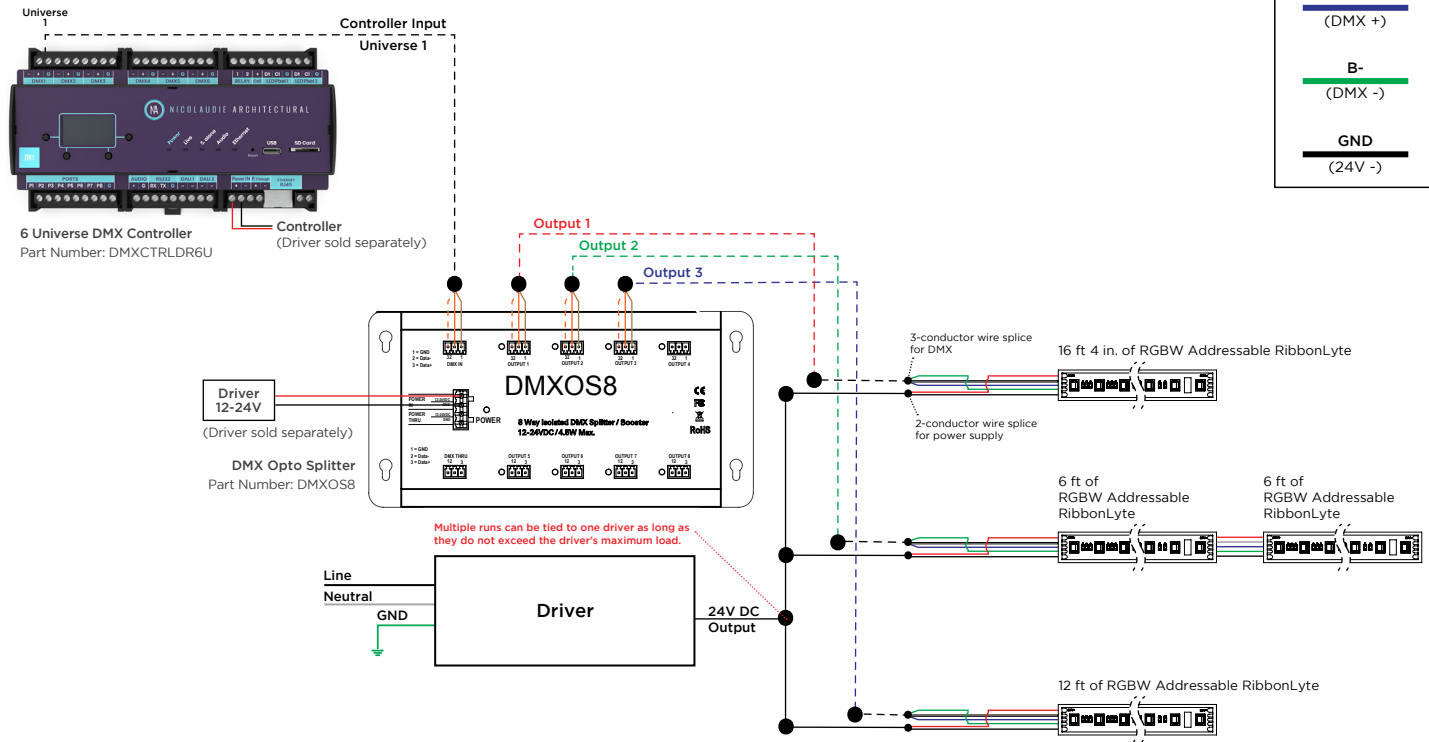

REV.08JAN2025

GLOBAL HQ

320 Murray Hill Pkwy
East Rutherford, NJ 07073
U.S.
T: (+1) 212 629 6830
E: Sales-US@GENLEDBrands.com

EUROPEAN HQ

Hogeweyselaan 119
1382 JK Weesp
Netherlands
T: (+31) 346 235 000
E: SalesEurope@GENLEDBrands.com

MEINA HQ

PO Box 371378, #823, Building 4EA
Dubai Airport Free Zone
Dubai, UAE
T: (+971) 4 701 7901
E: SalesMEINA@genlebrands.com

ASIA-PACIFIC HQ

Room 402, Building D
Shenshi Tongchuang Science and Technology Park
No. 16 Hongyin Road
Xingqiang Community, Xinhui Street
Guangming District, Shenzhen, China 518107
Sales: (+86) 139 1836 3905
Office: (+86) 755 8529 0710
E: Sales-Pacific@GENLEDBrands.com