

## AS30 CHANNEL FIXTURE

AS30 is an aluminum channel that mounts flush to the surface. AS30 offers the choice of clear, milky or black flat lens and round or square milky lens. Create a custom fixture with AS30 and our RibbonLyte products.

- Available for field assembly or factory assembly
- 1.31 in. (33.4 mm) wide by 1.17 in. (29.6 mm) deep with milky lens, 1.95 in. (49.5 mm) deep with round milky lens, 2.03 in. (51.6 mm) deep with square milky lens
- Beam angle: 100° with milky lens, 100x140° with round milky lens, 100°x150° with square milky lens
- Wattage range: 0.75 W/ft (2.46 W/m) to 12 W/ft (39.4 W/m)
- Static White delivered lumen range from 44.1 lm/ft (144.7 lm/m) up to 1273 lm/ft (4176 lm/m)
- Clear, Milky or Black lens

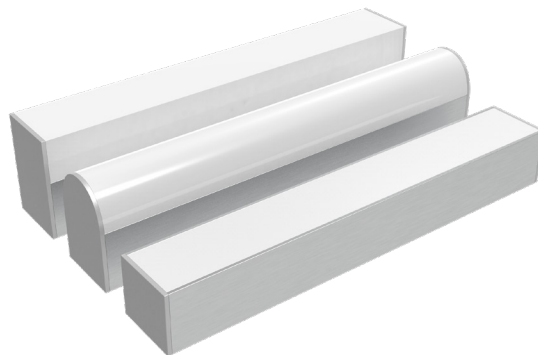

### HOUSING FINISHES



\*Additional fee applies

### LENS FINISHES



\*\* Our black lens offers great diffusion and helps hide fixtures that aren't in use.  
\*\*\* For interior applications only

### AVAILABLE COLORS & COLOR TEMPERATURES

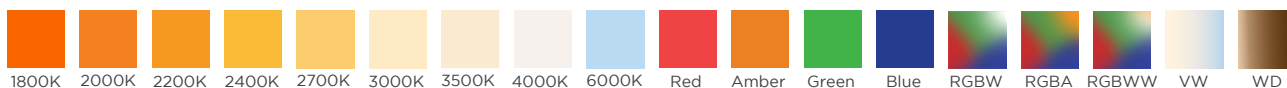

### DIMENSIONS

#### AS30 Channel

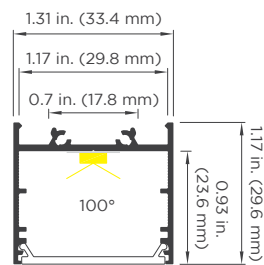

Width: 1.31 in. (33.4 mm)  
Height: 1.17 in. (29.6 mm)  
Internal Width: 1.17 in. (29.8 mm)  
Internal Height: 0.93 in. (23.6 mm)

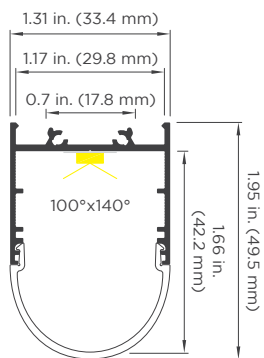

Width: 1.31 in. (33.4 mm)  
Height: 1.95 in. (49.5 mm)  
Internal Width: 1.17 in. (29.8 mm)  
Internal Height: 1.66 in. (42.2 mm)

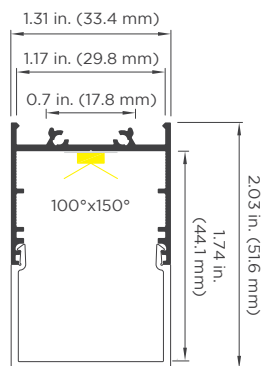

Width: 1.31 in. (33.4 mm)  
Height: 2.03 in. (51.6 mm)  
Internal Width: 1.17 in. (29.8 mm)  
Internal Height: 1.74 in. (44.1 mm)

#### Mounting Clip (included accessory)

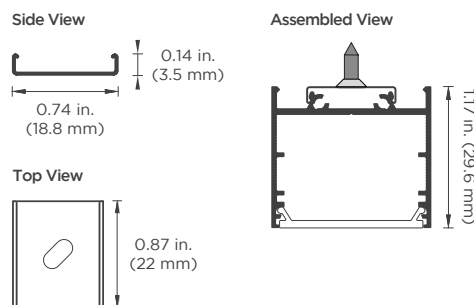

Width: 0.74 in. (18.8 mm)  
Length: 0.87 in. (22 mm)

- Note:**
1. **Magnetic mounting** option available (see page 2)
  2. **Exterior channel applications** should be securely attached to the mounting surface with appropriate screws and/or liquid nails. Acolyte strongly recommends field assembly for exterior applications. Use mounting clips for interior applications only.
  3. **Raised lenses** are for interior applications only.

**SPECIFICATIONS**

<b>Beam Angle</b>	100° with Milky Lens, 100x140° with Round Milky Lens, 100x150° with Square Milky Lens
<b>Lens Type</b>	Clear Lens, Milky Lens, Black Lens, Round Milky Lens, Square Milky Lens
<b>Length</b>	Channel is sold by the foot and cut to your exact desired length. Required amount of mounting clips included.
<b>Operating Voltage</b>	24 V
<b>Dimming</b>	MLV / 0-10 Volt / ELV / DALI / DMX
<b>Operating Temperature</b>	-40 – 158 °F (-40 – 70 °C)
<b>Colors</b>	1800K, 2000K, 2200K, 2400K, 2700K, 3000K, 3500K, 4000K, 6000K, Red, Amber, Green, Blue, RGBA, RGBW, RGBWW, VW, RGBW Addressable, Warm Dim (1800K, 2000K, 2200K only available in IP20)
<b>CRI</b>	90+ CRI (Static white only)
<b>Lamp Life</b>	L70 at 50,000 hours
<b>MacAdam ellipses (SDCM)</b>	2-Step Binning (For Static White LEDs only)
<b>Certifications</b>	UL Listed UL 2108 Issued: 2004/02/27 Ed: 1 Rev: 2014/02/24 Low Voltage Lighting Systems CSA C22.2#9.0 Issued: 1996/06/01 Ed: 1 (R2011) General Requirements for Luminaries; with Gen. Inst. 1: 1997, Gen Inst. 2: 1998. ROHS compliant

**ACCESSORIES (SEE PART NUMBERS AT STEP 4 ON PAGE 3)**

180° Coupler	End Cap (A) for channel with Flat Lens	End Cap (D) for channel with Round Lens	End Cap (E) for channel with Square Lens	Tiltable Stand
<p><b>End Cap Options:</b></p> <ol style="list-style-type: none"> <li>1. Use End Cap (A) for channel with Flat Lens</li> <li>2. Use End Cap (D) for channel with Round Milky Lens</li> <li>3. Use End Cap (E) for channel with Square Milky Lens</li> </ol>				<p>Assembled Height with channel and Flat Lens: 2.02 in. (51.4 mm)</p> <p>Assembled Height with channel and Round Lens: 2.81 in. (71.3 mm)</p> <p>Assembled Height with channel and Square Lens: 2.89 in. (73.4 mm)</p>

**Magnetic Mount**

Side View	Top View	Assembled View	
			<p>Assembled Height With Round Lens: 2.07 in. (52.68 mm)</p> <p>With Square Lens: 2.16 in. (54.78 mm)</p>



Ø 0.2 in. (5.08 mm)

ORDERING GUIDE

**STEP 1 Complete Channel Part Number**

CHANNEL	LENS	HOUSING COLOR	END CAP
<b>CHAS30</b>			
CHAS30 - AS30 Channel	<b>C</b> - Clear Lens <b>M</b> - Milky Lens <b>BK</b> - Black Lens <b>RM</b> - Round Milky Lens* <b>SM</b> - Square Milky Lens* * For interior applications only	<b>SV</b> - Silver <b>BK</b> - Black <b>WH</b> - White Consult factory for custom colors	<b>A</b> - End Cap for channel with Flat Lens <b>D</b> - End Cap for channel with Round Milky Lens <b>E</b> - End Cap for channel with Square Milky Lens

**STEP 2 Complete RibbonLyte Part Number**

CATEGORY	CRI	RIBBON TYPE & IP RATING		
<b>RB</b>				
RB - RibbonLyte	<b>0</b> - Static Color, Color Changing <b>90</b> - 90+ CRI Static White	<b>LINEA20</b> - Linea RibbonLyte IP20 <b>SWS220</b> - Static White Series 2 IP20 <b>SWS265</b> - Static White Series 2 IP65 <b>SWS268</b> - Static White Series 2 IP68 <b>SWDR20</b> - Static White Double Row IP20 <b>SCS220</b> - Static Color Series 2 IP20 <b>SCS265</b> - Static Color Series 2 IP65 <b>SCS268</b> - Static Color Series 2 IP68	<b>RGBWS220</b> - RGBW Series 2 IP20 <b>RGBWS265</b> - RGBW Series 2 IP65 <b>RGBWS268</b> - RGBW Series 2 IP68 <b>RGBWADR20</b> - RGBW/A Double Row IP20 <b>RGBWW20</b> - RGBWW 5-in-1 IP20 <b>RGBWADD</b> - Addressable RGBW <b>RGBWADR20</b> - RGBW/A Double Row IP20 <b>VWDR20</b> - Variable White Double Row IP20	<b>VWS220</b> - VW Series 2 IP20 <b>VWS265</b> - VW Series 2 IP65 <b>VWS268</b> - VW Series 2 IP68 <b>WD20</b> - Warm Dim IP20 <b>WD65</b> - Warm Dim IP65 <b>WD68</b> - Warm Dim IP68

**NOTE:** To ensure waterproofing standards are met, IP65, IP67, and IP68 RibbonLyte can NOT be cut in the field.

WATTAGE	COLOR
0.75 - 0.75 W/ft (2.46 W/m - Static White, Static Color)	<b>18</b> - 1800K <b>VW</b> - Variable White
1.0 - 1.0 W/ft (3.3 W/m - Variable White)	<b>20</b> - 2000K <b>RGB27</b> - Red, Green, Blue + 2700K
1.5 - 1.5 W/ft (4.9 W/m - Static White, Static Color)	<b>22</b> - 2200K <b>RGB30</b> - Red, Green, Blue + 3000K
2.2 - 2.2 W/ft (7.2 W/m - Static White, Static Color)	<b>24</b> - 2400K <b>RGB40</b> - Red, Green, Blue + 4000K
2.4 - 2.4 W/ft (8 W/m - Static White Linea)	<b>27</b> - 2700K <b>RGB2465</b> - Red, Green, Blue + 2400K + 6500K
3.0 - 3.0 W/ft (9.8 W/m - Static White, Static Color, Variable White, RGBW, RGBA)	<b>30</b> - 3000K <b>RGBA</b> - Red, Green, Blue + Amber
4.3 - 4.3 W/ft (14 W/m - Static White Linea)	<b>35</b> - 3500K <b>RGBW30</b> - RGB + 3000K Addressable
4.4 - 4.4 W/ft (14.4 W/m - Static White, Static Color, RGBW, RGBWW, RGBA)	<b>40</b> - 4000K <b>RGBW40</b> - RGB + 4000K Addressable
5.0 - 5.0 W/ft (16.4 W/m - Static White, Static Color)	<b>60</b> - 6000K <b>RGBW60</b> - RGB + 6000K Addressable
5.2 - 5.2 W/ft (17.1 W/m - Warm Dim)	<b>R</b> - Red <b>2920</b> - Warm Dim 2900K - 2000K (IP20)
5.5 - 5.5 W/ft (18.0 W/m - RGBW, RGBA)	<b>A</b> - Amber <b>2721</b> - Warm Dim 2700K - 2100K (IP65+IP68)
6.0 - 6.0 W/ft (19.7 W/m - Static White, Static Color, Variable White, RGBW, RGBA, RGBW Addressable)	<b>G</b> - Green <b>Z</b> - Undecided**
6.1 - 6.1 W/ft (20 W/m - Variable White Linea)	<b>B</b> - Blue ** For quotes only. Must be chosen before final order.
8.8 - 8.8 W/ft (28.9 W/m - RGBW, RGBWW, RGBA)	
12.0 - 12.0 W/ft (39.4 W/m - Static White, Variable White, RGBW, RGBA)	

CONNECTION OPTIONS (See diagrams on the right)

ASSEMBLY OPTION	LENGTH (Standard factory assembled length up to 6 ft 6.7 in. / 2 m)
1 - End Feed Bare Wire Connection	Custom Length (ft.)
2 - Back Feed Bare Wire Connection	
3 - Side Feed Bare Wire Connection	
4 - End Feed with IP67 Male Coupler	
5 - Soldered Daisy Chain	
6 - Daisy Chain With IP67 Couplers	

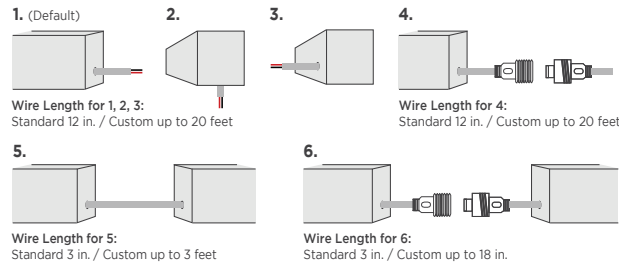

**STEP 3 Complete Assembly Option & Length**

ASSEMBLY OPTION	LENGTH (Standard factory assembled length up to 6 ft 6.7 in. / 2 m)
FI - Field Assembly	
FA - Factory Assembly* (not recommended for exterior applications)	

\* Factory assembled runs exceeding 6 ft 6.7 in. (2 m) will be split into multiple daisy chained fixtures.

**DO NOT BUTT END CAPS AGAINST EACH OTHER WHEN CREATING LONGER FIXTURES**  
Acolyte STRONGLY SUGGESTS field assembly (without using interior end caps) for direct-view fixtures of more than 6 ft 6.7 in. (2 m) in length. Field assembly without interior end caps will eliminate gaps or dead spots that can be caused by butting interior end caps against each other.

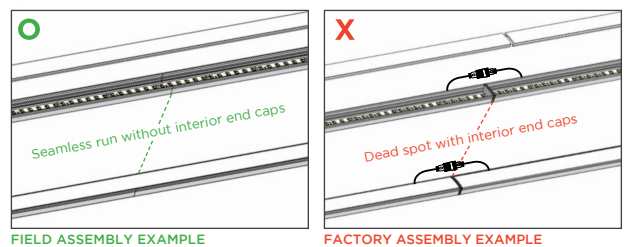

**STEP 4 Add Accessories**

ACCESSORIES
CHCOUP180AW38SV - 180° Coupler Silver
TILTSTANDST - Tilttable Stand
CHMAGO.5 - Magnetic Mount

RIBBONLYTE SPECIFICATIONS & COMPATIBILITY

Available Wattage	Cutttable Length	LED Pitch	Color Temp.	lm/W without Lens	Delivered Lumens (lm/ft / lm/m)					Max Length	Compatible with Channel		
					with Clear Lens	with Milky Lens	with Black Lens	with Round Lens	with Square Lens		IP20	IP65	IP68
0.75 Static White Series 2	1.97 in. (50 mm)	48 LEDs/ft (160 LEDs/m)	1800K	84	59 / 192	47 / 155	44 / 145	47 / 155	47 / 155	IP20: 49 ft (15 m) IP65/IP68: 32.8 ft (10 m)	✓	✓	✓
			2000K	99	69 / 227	56 / 183	52 / 171	56 / 183	56 / 183				
			2200K	109	76 / 249	61 / 201	57 / 188	61 / 201	61 / 201				
			2400K	113	79 / 259	64 / 209	59 / 195	64 / 209	64 / 209				
			2700K	123	86 / 281	69 / 227	65 / 212	69 / 227	69 / 227				
			3000K	123	86 / 281	69 / 227	65 / 212	69 / 227	69 / 227				
			3500K	130	91 / 297	73 / 240	68 / 224	73 / 240	73 / 240				
			4000K	134	93 / 307	75 / 247	70 / 231	75 / 247	75 / 247				
			6000K	131	91 / 300	74 / 242	69 / 226	74 / 242	74 / 242				
1.5 Static White Series 2	1.97 in. (50 mm)	48 LEDs/ft (160 LEDs/m)	1800K	84	117 / 384	95 / 310	88 / 289	95 / 310	95 / 310	IP20: 49 ft (15 m) IP65/IP68: 32.8 ft (10 m)	✓	✓	✓
			2000K	98	137 / 449	110 / 362	103 / 338	110 / 362	110 / 362				
			2200K	109	152 / 499	123 / 402	114 / 375	123 / 402	123 / 402				
			2400K	113	158 / 517	127 / 417	119 / 389	127 / 417	127 / 417				
			2700K	123	172 / 563	138 / 454	129 / 424	138 / 454	138 / 454				
			3000K	123	172 / 563	138 / 454	129 / 424	138 / 454	138 / 454				
			3500K	129	180 / 590	145 / 476	135 / 444	145 / 476	145 / 476				
			4000K	134	187 / 613	151 / 495	141 / 462	151 / 495	151 / 495				
			6000K	131	183 / 600	147 / 484	138 / 451	147 / 484	147 / 484				
2.2 Static White Series 2	1.97 in. (50 mm)	48 LEDs/ft (160 LEDs/m)	1800K	83	170 / 557	137 / 449	128 / 419	137 / 449	137 / 449	IP20: 42 ft (12.8 m) IP65/IP68: 32.8 ft (10 m)	✓	✓	✓
			2000K	96	196 / 644	158 / 520	148 / 485	158 / 520	158 / 520				
			2200K	106	217 / 712	175 / 574	163 / 536	175 / 574	175 / 574				
			2400K	111	227 / 745	183 / 601	171 / 561	183 / 601	183 / 601				
			2700K	120	246 / 806	198 / 650	185 / 606	198 / 650	198 / 650				
			3000K	122	250 / 819	201 / 660	188 / 616	201 / 660	201 / 660				
			3500K	127	260 / 852	210 / 687	196 / 642	210 / 687	210 / 687				
			4000K	133	272 / 893	219 / 720	205 / 672	219 / 720	219 / 720				
			6000K	128	262 / 859	211 / 693	197 / 647	211 / 693	211 / 693				
3.0 Static White Series 2	1.97 in. (50 mm)	48 LEDs/ft (160 LEDs/m)	1800K	84	234 / 769	189 / 620	176 / 579	189 / 620	189 / 620	IP20: 36 ft (11 m) IP65/IP68: 32.8 ft (10 m)	✓	✓	✓
			2000K	98	273 / 897	221 / 723	206 / 675	221 / 723	221 / 723				
			2200K	108	301 / 989	243 / 797	227 / 744	243 / 797	243 / 797				
			2400K	109.8	306 / 1005	247 / 811	231 / 756	247 / 811	247 / 811				
			2700K	122.9	343 / 1125	277 / 907	258 / 847	277 / 907	277 / 907				
			3000K	130	363 / 1190	293 / 960	273 / 896	293 / 960	293 / 960				
			3500K	133	371 / 1217	299 / 982	279 / 916	299 / 982	299 / 982				
			4000K	133	371 / 1217	299 / 982	276 / 916	299 / 982	299 / 982				
			6000K	128	357 / 1172	288 / 945	269 / 882	288 / 945	288 / 945				
4.4 Static White Series 2	1.97 in. (50 mm)	48 LEDs/ft (160 LEDs/m)	1800K	81	331 / 1087	267 / 877	249 / 818	267 / 877	267 / 877	28 ft 4 in. (8.64 m)	✓	✓	✓
			2000K	95	389 / 1275	314 / 1029	293 / 960	314 / 1029	314 / 1029				
			2200K	105	430 / 1410	347 / 1137	323 / 1061	347 / 1137	347 / 1137				
			2400K	109	446 / 1463	360 / 1180	336 / 1101	360 / 1180	360 / 1180				
			2700K	122	499 / 1638	403 / 1321	376 / 1233	403 / 1321	403 / 1321				
			3000K	129	528 / 1732	426 / 1397	397 / 1304	426 / 1397	426 / 1397				
			3500K	132	540 / 1772	436 / 1429	407 / 1334	436 / 1429	436 / 1429				
			4000K	132	540 / 1772	436 / 1429	407 / 1334	436 / 1429	436 / 1429				
			6000K	126	516 / 1692	416 / 1364	388 / 1273	416 / 1364	416 / 1364				
5.0 Static White Series 2	1.4 in. (35.7 mm)	68 LEDs/ft (224 LEDs/m)	1800K	83	386 / 1266	311 / 1021	291 / 953	311 / 1021	311 / 1021	IP20: 33 ft 4 in. (10.1 m) IP65/IP68: 32.8 ft (10 m)	✓	✓	✓
			2000K	98	456 / 1495	368 / 1206	343 / 1125	368 / 1206	368 / 1206				
			2200K	107	498 / 1632	401 / 1316	375 / 1229	401 / 1316	401 / 1316				
			2400K	110	511 / 1675	412 / 1351	384 / 1261	412 / 1351	412 / 1351				
			2700K	123	571 / 1875	461 / 1512	430 / 1411	461 / 1512	461 / 1512				
			3000K	130	605 / 1983	488 / 1599	455 / 1493	488 / 1599	488 / 1599				
			3500K	133	618 / 2029	499 / 1636	466 / 1527	499 / 1636	499 / 1636				
			4000K	133	618 / 2029	499 / 1636	466 / 1527	499 / 1636	499 / 1636				
			6000K	127	591 / 1937	476 / 1562	445 / 1458	476 / 1562	476 / 1562				
6.0 Static White Series 2	1.4 in. (35.7 mm)	68 LEDs/ft (224 LEDs/m)	1800K	82	458 / 1501	369 / 1211	344 / 1130	369 / 1211	369 / 1211	28 ft (8.5 m)	✓	✓	✓
			2000K	95	530 / 1739	428 / 1403	399 / 1309	428 / 1403	428 / 1403				
			2200K	106	591 / 1941	477 / 1565	445 / 1461	477 / 1565	477 / 1565				
			2400K	109	608 / 1995	491 / 1609	458 / 1502	491 / 1609	491 / 1609				
			2700K	122	681 / 2233	549 / 1801	512 / 1681	549 / 1801	549 / 1801				
			3000K	129	720 / 2362	581 / 1905	542 / 1778	581 / 1905	581 / 1905				
			3500K	132	737 / 2417	594 / 1949	554 / 1819	594 / 1949	594 / 1949				
			4000K	132	737 / 2417	594 / 1949	554 / 1819	594 / 1949	594 / 1949				
			6000K	126	703 / 2307	567 / 1860	529 / 1736	567 / 1860	567 / 1860				

**RIBBONLYTE SPECIFICATIONS & COMPATIBILITY**

Available Wattages	Cutttable Length	LED Pitch	Color Temp.	lm/W without Lens	Delivered Lumens (lm/ft / lm/m)					Max Length	Compatible with Channel		
					with Clear Lens	with Milky Lens	with Black Lens	with Round Lens	with Square Lens		IP20	IP65	IP68
3.0 Static White Double Row	0.7 in. (17.9 mm)	136 LEDs/ft (448 LEDs/m)	1800K	73	206 / 676	202 / 662	153 / 504	158 / 518	158 / 518	65 ft 7 in. (20 m)	✓	N/A	N/A
			2000K	86	243 / 798	238 / 781	181 / 595	186 / 612	186 / 612				
			2200K	94	266 / 872	260 / 853	198 / 649	204 / 668	204 / 668				
			2400K	97	273 / 896	267 / 877	203 / 667	209 / 686	209 / 686				
			2700K	109	308 / 1010	301 / 989	229 / 752	236 / 774	236 / 774				
			3000K	118	333 / 1092	326 / 1069	248 / 813	255 / 836	255 / 836				
			3500K	119	335 / 1100	328 / 1077	250 / 819	257 / 843	257 / 843				
			4000K	118	333 / 1092	326 / 1069	248 / 813	255 / 836	255 / 836				
6000K	114	323 / 1059	316 / 1037	240 / 789	247 / 811	247 / 811							
6.0 Static White Double Row	0.7 in. (17.9 mm)	136 LEDs/ft (448 LEDs/m)	1800K	73	412 / 1353	403 / 1324	307 / 1007	316 / 1036	316 / 1036	39 ft (12 m)	✓	N/A	N/A
			2000K	86	487 / 1597	476 / 1563	362 / 1189	373 / 1223	373 / 1223				
			2200K	94	531 / 1744	520 / 1707	396 / 1298	407 / 1336	407 / 1336				
			2400K	97	546 / 1792	535 / 1754	407 / 1335	418 / 1373	418 / 1373				
			2700K	109	616 / 2021	603 / 1978	459 / 1505	472 / 1548	472 / 1548				
			3000K	118	666 / 2184	651 / 2137	496 / 1626	510 / 1673	510 / 1673				
			3500K	119	670 / 2200	656 / 2153	499 / 1638	514 / 1685	514 / 1685				
			4000K	118	666 / 2184	651 / 2137	496 / 1626	510 / 1673	510 / 1673				
6000K	114	646 / 2118	632 / 2073	481 / 1578	495 / 1623	495 / 1623							
12.0 Static White Double Row	0.7 in. (17.9 mm)	136 LEDs/ft (448 LEDs/m)	1800K	69	783 / 2567	766 / 2513	583 / 1912	599 / 1967	599 / 1967	26 ft 3 in. (8 m)	✓	N/A	N/A
			2000K	82	924 / 3031	904 / 2967	688 / 2257	708 / 2322	708 / 2322				
			2200K	89	1009 / 3310	987 / 3239	751 / 2465	773 / 2535	773 / 2535				
			2400K	92	1037 / 3403	1015 / 3330	772 / 2534	794 / 2606	794 / 2606				
			2700K	104	1169 / 3836	1144 / 3754	871 / 2856	895 / 2938	895 / 2938				
			3000K	112	1263 / 4145	1236 / 4057	941 / 3087	968 / 3175	968 / 3175				
			3500K	113	1273 / 4176	1246 / 4087	948 / 3110	975 / 3199	975 / 3199				
			4000K	112	1263 / 4145	1236 / 4057	941 / 3087	968 / 3175	968 / 3175				
6000K	109	1226 / 4021	1200 / 3936	913 / 2995	939 / 3080	939 / 3080							
0.75 Static Color Series 2	1.97 in. (50 mm)	48 LEDs/ft (160 LEDs/m)	Red	41	29 / 94	23 / 76	22 / 71	23 / 76	23 / 76	IP20: 49 ft (15 m) IP65/IP68: 32.8 ft (10 m)	✓	✓	✓
			Green	175	122 / 400	98 / 323	92 / 301	98 / 323	98 / 323				
			Blue	19	13.3 / 43	10.7 / 35	10 / 33	10.7 / 35	10.7 / 35				
			Amber	34	24 / 78	19 / 63	18 / 59	19 / 63	19 / 63				
1.5 Static Color Series 2	1.97 in. (50 mm)	48 LEDs/ft (160 LEDs/m)	Red	42	59 / 192	47 / 155	44 / 145	47 / 155	47 / 155	IP20: 49 ft (15 m) IP65/IP68: 32.8 ft (10 m)	✓	✓	✓
			Green	160	223 / 732	180 / 591	168 / 551	180 / 591	180 / 591				
			Blue	18	25 / 82	20 / 66	19 / 62	20 / 66	20 / 66				
			Amber	34	47 / 156	38 / 125	36 / 117	38 / 125	38 / 125				
2.2 Static Color Series 2	1.97 in. (50 mm)	48 LEDs/ft (160 LEDs/m)	Red	42	86 / 282	69 / 227	65 / 212	69 / 227	69 / 227	IP20: 42 ft (12.8 m) IP65/IP68: 32.8 ft (10 m)	✓	✓	✓
			Green	145	297 / 973	239 / 785	223 / 733	239 / 785	239 / 785				
			Blue	18	37 / 121	30 / 97	28 / 91	30 / 97	30 / 97				
			Amber	34	70 / 228	56 / 184	52 / 172	56 / 184	56 / 184				
3.0 Static Color Series 2	1.97 in. (50 mm)	48 LEDs/ft (160 LEDs/m)	Red	40	112 / 366	90 / 295	84 / 276	90 / 295	90 / 295	32.8 ft (10 m)	✓	✓	✓
			Green	127	354 / 1162	286 / 937	267 / 875	286 / 937	286 / 937				
			Blue	25	70 / 229	56 / 185	53 / 172	56 / 185	56 / 185				
			Amber	29	81 / 265	65 / 214	61 / 200	65 / 214	65 / 214				
4.4 Static Color Series 2	1.97 in. (50 mm)	48 LEDs/ft (160 LEDs/m)	Red	38	155 / 510	125 / 411	117 / 384	125 / 411	125 / 411	29 ft (8.8 m)	✓	✓	✓
			Green	117	479 / 1571	386 / 1267	360 / 1182	386 / 1267	386 / 1267				
			Blue	24	98 / 322	79 / 260	74 / 243	79 / 260	79 / 260				
			Amber	25	102 / 336	83 / 271	77 / 253	83 / 271	83 / 271				
5.0 Static Color Series 2	1.4 in. (35.7 mm)	68 LEDs/ft (224 LEDs/m)	Red	37	172 / 564	139 / 455	130 / 425	139 / 455	139 / 455	30 ft (9.14 m)	✓	✓	✓
			Green	116	539 / 1770	435 / 1427	406 / 1332	435 / 1427	435 / 1427				
			Blue	24	112 / 366	90 / 295	84 / 276	90 / 295	90 / 295				
			Amber	26	121 / 397	98 / 320	91 / 299	98 / 320	98 / 320				

**RIBBONLYTE SPECIFICATIONS & COMPATIBILITY**

Available Wattages	Cuttable Length	LED Pitch	Color Temp.	lm/W without Lens	Delivered Lumens (lm/ft / lm/m)					Max Length	Compatible with Channel		
					with Clear Lens	with Milky Lens	with Black Lens	with Round Lens	with Square Lens		IP20	IP65	IP68
6.0 Static Color Series 2	1.4 in. (35.7 mm)	68 LEDs/ft (224 LEDs/m)	Red	37	206 / 677	167 / 546	155 / 510	167 / 546	167 / 546	28 ft (8.5 m)	✓	✓	✓
			Green	113	631 / 2069	509 / 1668	475 / 1557	509 / 1668	509 / 1668				
			Blue	23	128 / 421	104 / 340	97 / 317	104 / 340	104 / 340				
			Amber	24	134 / 439	108 / 354	101 / 331	108 / 354	108 / 354				
2.4 Static White Linea	1.97 in. (50 mm)	146 LEDs/ft (480 LEDs/m)	2700K	67	149.7 / 491	120.8 / 396	112.7 / 369.6	120.8 / 396	120.8 / 396	21.3 ft (6.5 m)	✓	N/A	N/A
			3000K	71	158.1 / 519.9	127.5 / 419.3	119 / 391.3	127.5 / 419.3	127.5 / 419.3				
			3500K	83	185.1 / 608.2	149.3 / 490.5	139.3 / 457.8	149.3 / 490.5	149.3 / 490.5				
			4000K	83	185.1 / 608.2	149.3 / 490.5	139.3 / 457.8	149.3 / 490.5	149.3 / 490.5				
3.0 Static White Linea	1.97 in. (50 mm)	146 LEDs/ft (480 LEDs/m)	2700K	66	184.1 / 604.5	148.5 / 487.5	138.6 / 455	148.5 / 487.5	148.5 / 487.5	21.3 ft (6.5 m)	✓	N/A	N/A
			3000K	73	203.7 / 668.7	164.3 / 539.3	153.3 / 503.3	164.3 / 539.3	164.3 / 539.3				
			3500K	78	217.6 / 714.2	175.5 / 576	163.8 / 537.6	175.5 / 576	175.5 / 576				
			4000K	83	217.6 / 714.2	186.8 / 612.8	174.3 / 571.9	186.8 / 612.8	186.8 / 612.8				
4.3 Static White Linea	1.97 in. (50 mm)	146 LEDs/ft (480 LEDs/m)	2700K	75	300.4 / 983.9	242.3 / 793.5	226.1 / 740.6	242.3 / 793.5	242.3 / 793.5	24.6 ft (7.5 m)	✓	N/A	N/A
			3000K	78	311.6 / 1023	251.3 / 825	234.5 / 770	251.3 / 825	251.3 / 825				
			3500K	86	344.1 / 1129	277.5 / 910.5	259 / 849.8	277.5 / 910.5	277.5 / 910.5				
			4000K	86	344.1 / 1129	277.5 / 910.5	259 / 849.8	277.5 / 910.5	277.5 / 910.5				
6.1 Variable White Linea	1.09 in. (27.78 mm)	175 LEDs/ft (576 LEDs/m)	2700K + 6500K	95	539.4 / 1769.8	435 / 1427.3	406 / 1332.1	435 / 1427.3	435 / 1427.3	16.4 ft (5 m)	✓	N/A	N/A
1.0 Variable White Series 2	1.97 in. (50 mm)	42 LEDs/ft (140 LEDs/m)	2000K + 6500K	85	79.1 / 259	63.8 / 209	59.5 / 195	63.8 / 209	63.8 / 209	32.8 ft (10 m)	✓	✓	✓
3.0 Variable White Series 2	1.97 in. (50 mm)	42 LEDs/ft (140 LEDs/m)	2000K + 6500K	80	223.2 / 732	180 / 591	168 / 551	180 / 591	180 / 591	32.8 ft (10 m)	✓	✓	✓
6.0 Variable White Series 2	1.97 in. (50 mm)	42 LEDs/ft (140 LEDs/m)	2000K + 6500K	75	418.5 / 1373	337.5 / 1107	315 / 1033	337.5 / 1107	337.5 / 1107	19 ft 8 in. (6 m)	✓	✓	✓
3.0 Variable White Double Row	1.97 in. (50 mm)	84 LEDs/ft (280 LEDs/m)	2000K + 6500K	87	245 / 805	240 / 788	183 / 599	188 / 617	188 / 617	65 ft 7 in. (20 m)	✓	N/A	N/A
6.0 Variable White Double Row	1.97 in. (50 mm)	84 LEDs/ft (280 LEDs/m)	2000K + 6500K	82	462 / 1517	453 / 1485	344 / 1130	354 / 1162	354 / 1162	45 ft 11 in. (14 m)	✓	N/A	N/A
12.0 Variable White Double Row	1.97 in. (50 mm)	84 LEDs/ft (280 LEDs/m)	2000K + 6500K	71	801 / 2628	784 / 2572	596 / 1957	613 / 2013	613 / 2013	22 ft 11 in. (7 m)	✓	N/A	N/A
4.4 RGBW Series 2	1.97 in. (50 mm)	36 LEDs/ft (120 LEDs/m)	RGBW	45	188.1 / 617.2	148.5 / 487.2	138.6 / 454.7	138.6 / 454.7	138.6 / 454.7	19 ft 8 in. (6 m)	✓	N/A	N/A
5.5 RGBW Series 2	1.97 in. (50 mm)	36 LEDs/ft (120 LEDs/m)	RGBW	59	308.8 / 1013	243.3 / 798.5	227.2 / 745.3	272.2 / 745.3	272.2 / 745.3	IP65: 16 ft 4 in. (5 m) IP68: 19 ft 7.9 in. (6 m)	N/A	✓	✓
8.8 RGBW Series 2	1.97 in. (50 mm)	36 LEDs/ft (120 LEDs/m)	RGBW	61	510.2 / 1673.8	402.6 / 1320.9	375.8 / 1232.9	375.8 / 1232.9	375.8 / 1232.9	16 ft 4 in. (5 m)	✓	N/A	N/A

**RIBBONLYTE SPECIFICATIONS & COMPATIBILITY**

Available Wattages	Cuttable Length	LED Pitch	Color Temp.	lm/W without Lens	Delivered Lumens (lm/ft / lm/m)					Max Length	Compatible with Channel		
					with Clear Lens	with Milky Lens	with Black Lens	with Round Lens	with Square Lens		IP20	IP65	IP68
4.4 RGBW Series 2	1.97 in. (50 mm)	36 LEDs/ft (120 LEDs/m)	RGBW	45	188.1 / 617.2	148.5 / 487.2	138.6 / 454.7	138.6 / 454.7	138.6 / 454.7	19 ft 8 in. (6 m)	✓	N/A	N/A
5.5 RGBW Series 2	1.97 in. (50 mm)	36 LEDs/ft (120 LEDs/m)	RGBW	59	308.8 / 1013	243.3 / 798.5	227.2 / 745.3	272.2 / 745.3	272.2 / 745.3	IP65: 16 ft 4 in. (5 m) IP68: 19 ft 7.9 in. (6 m)	N/A	✓	✓
8.8 RGBW Series 2	1.97 in. (50 mm)	36 LEDs/ft (120 LEDs/m)	RGBW	61	510.2 / 1673.8	402.6 / 1320.9	375.8 / 1232.9	375.8 / 1232.9	375.8 / 1232.9	16 ft 4 in. (5 m)	✓	N/A	N/A
3.0 RGBW Double Row	1.3 in. (33 mm)	72 LEDs/ft (240 LEDs/m)	RGBW	91	257 / 842	251 / 824	191 / 627	205 / 672	205 / 672	26 ft 3 in. (8 m)	✓	N/A	N/A
3.0 RGBA Double Row	1.3 in. (33 mm)	72 LEDs/ft (240 LEDs/m)	RGBA	78	257 / 842	251 / 824	191 / 627	205 / 672	205 / 672	26 ft 3 in. (8 m)	✓	N/A	N/A
6.0 RGBW Double Row	1.3 in. (33 mm)	72 LEDs/ft (240 LEDs/m)	RGBW	91	513 / 1684	502 / 1648	382 / 1254	410 / 1344	410 / 1344	22 ft 11 in. (7 m)	✓	N/A	N/A
6.0 RGBA Double Row	1.3 in. (33 mm)	72 LEDs/ft (240 LEDs/m)	RGBA	80	513 / 1684	502 / 1648	382 / 1254	410 / 1344	410 / 1344	22 ft 11 in. (7 m)	✓	N/A	N/A
12.0 RGBW Double Row	1.3 in. (33 mm)	72 LEDs/ft (240 LEDs/m)	RGBW	79	891 / 2924	872 / 2862	664 / 2177	711 / 2333	711 / 2333	14 ft 9 in. (4.5 m)	✓	N/A	N/A
12.0 RGBA Double Row	1.3 in. (33 mm)	72 LEDs/ft (240 LEDs/m)	RGBA	75	891 / 2924	872 / 2862	664 / 2177	711 / 2333	711 / 2333	14 ft 9 in. (4.5 m)	✓	N/A	N/A
4.4 5-in-1 RGBWW	2.46 in. (62.5 mm)	29 LED/ft (96 LED/m)	RGBWW	59	241.4 / 792.1	194.7 / 638.8	181.7 / 308.0	181.7 / 596.2	181.7 / 596.2	16 ft 4 in (5 m)	✓	N/A	N/A
8.8 5-in-1 RGBWW	2.46 in. (62.5 mm)	29 LED/ft (96 LED/m)	RGBWW	50	409.2 / 1342.6	330.0 / 1082.7	596.2 / 1010.5	308.0 / 1010.5	308.0 / 1010.5	11 ft 6 in (3.5 m)	✓	N/A	N/A
RGBW Addressable	3.94 in. (100 mm)	18 LEDs/ft (60 LEDs/m)	Red	33.5	30.8 / 101.2	23.5 / 77	23.5 / 77	25.1 / 82.5	25.1 / 82.5	16 ft 5.64 in. (5.02 m)	N/A	N/A	✓ IP67
			Green	82	75.4 / 247.5	57.4 / 188.3	57.4 / 188.3	61.5 / 201.8	61.5 / 201.8				
			Blue	15.5	14.2 / 46.7	10.8 / 35.6	10.8 / 35.6	11.6 / 38.1	11.6 / 38.1				
			White	103	94.8 / 310.9	72.1 / 236.6	72.1 / 236.6	77.3 / 253.5	77.3 / 253.5				
			All	40	222.8 / 730.8	169.5 / 556.1	169.5 / 556.1	181.6 / 595.8	181.6 / 595.8				
5.2 Warm Dim	3.94 in. (100 mm)	36 LEDs/ft (120 LEDs/m)	WARM DIM	55	266 / 873	214.5 / 704	200.2 / 657	214.5 / 704	214.5 / 704	16 ft 4 in. (5 m)	✓	✓	✓

**DIODE VISIBILITY CHART** (Data below applies to installations with Milky lens only)

 <p><b>No Visible Diode = N</b> Note: Linea RibbonLyte has no visible diode</p>				 <p><b>With Visible Diode = Y</b></p>									
Static White & Static Color RibbonLyte			Static White Double Row	Color Changing RibbonLyte									
0.75/1.5/2.2	3.0/4.4	5.0/6.0	3.0/6.0/12.0	4.4 RGBW Series 2	5.5 RGBW Series 2	8.8 RGBW Series 2	3.0/6.0/12.0 RGBW/A Double Row	4.4/8.8 5-in-1 RGBWW	Warm Dim	Variable White Series 2	3.0/6.0/12.0 Variable White Double Row	RGBW Addressable	
IP20 IP65 IP68	IP20 IP65 IP68	IP20 IP65 IP68	IP20	IP20	IP65 IP68	IP20	IP20	IP20	IP20 IP65 IP68	IP20 IP65 IP68	IP20	IP67	
<b>N</b>	<b>N</b>	<b>N</b>	<b>N</b>	<b>N</b>	<b>N</b>	<b>N</b>	<b>N</b>	<b>N</b>	<b>N</b>	<b>N</b>	<b>N</b>	<b>N</b>	



AVAILABLE DRIVERS / CONTROLLERS AND DIMMING OPTIONS / WIRE GAUGE CHART

NON-DIMMING ELECTRONIC DRIVERS      ELV & MLV DRIVERS      DIMMABLE DALI DRIVERS



**30W, 60W, 96W Non-Dimming Electronic Class 2 Drivers**

Part No.:  
• DRVW2430 (30 Watt)  
• DRVW2460 (60 Watt)  
• DRVW2496 (96 Watt)  
Output Voltage: 24 VDC  
Input Voltage: 120-277 VAC  
IP65, dry/damp location  
UL Listed



**240W, 320W Non-Dimming Electronic Drivers**

Part No.:  
• DRVW24240 (240 Watt)  
• DRVW24320 (320 Watt)  
Output Voltage: 24 VDC  
Input Voltage: 90-305 VAC  
IP65, dry/damp location  
UL Recognized



**60W, 96W Non-Dimming Compact Drivers**

Part No.:  
• DRV2460C (60 Watt)  
• DRV2496C (96 Watt)  
Output Voltage: 24 VDC  
Input Voltage: 120-277 VAC  
IP20, dry location  
UL Class P



**60W, 96W, 150W, 300W ELV/MLV Dimmable Drivers**

Part No.:  
• DRVW2460ELVMLV (60 Watt)  
• DRVW2496ELVMLV (96 Watt)  
• DRVW24150ELVMLV (150 Watt)  
• DRVW24300ELVMLV (300 Watt)  
Line Voltage Dimmable Drivers  
Output Voltage: 24 VDC  
Input Voltage: 100-277 VAC  
IP67, damp/wet location  
UL, CE, and CSA Listed



**100W 1 Channel, 100W 2 Channel, 150W 4 Channel Dimmable DALI Drivers**

Part No.:  
• DRV100DALI1CH (100W 1 channel)  
• DRV100DALI2CH (100W 2 channel)  
• DRV150DALI4CH (150W 4 channel)  
Output Voltage: 24 VDC  
Input Voltage: 120-277 VAC  
IP20, dry location  
CE, UL Recognized, FCC, RoHS, SELV

0-10V DRIVERS      ATHENA WIRELESS COMPATIBLE      DIMMABLE DALI-2 DRIVERS



**0-10V Dimmable Waterproof Drivers**

• Part No.: DRVW249610P (96 Watt)  
• Part No.: DRVW2428810P (288 Watt)  
Output Voltage: 24 VDC (+/- 0.5 V)  
Input Voltage: 100-277 VAC  
UL wet location  
UL Listed



**0-10V Dimmable 90W VW/WD Driver**

• Part No.: DRVRFWDVW2490120  
Output Voltage: 24 VDC  
Input Voltage: 100-277 VAC  
IP23, dry/damp location  
UL Listed



**94W Athena Wireless Compatible Drivers**

• Part No.: DRVW2494ATH1CH (1 channel)  
• Part No.: DRVW2494ATH2CH (2 channel)  
Output Voltage: 24 VDC  
Input Voltage: 100-277 VAC  
Dry location  
UL Listed



**96W DIMMABLE DALI-2 DT6 D4I & DALI-2 DT8 D4I DRIVERS**

• Part No.: DRVW2496DALI1CH (1 channel)  
• Part No.: DRVW2496DALI2CH (2 channel)  
Output Voltage: 24-26 VDC  
Input Voltage: 120-277 VAC  
IP67, wet location  
UL Listed

DMX CONTROLLERS, VARIABLE WHITE DIMMER, WARM DIM DIMMER - FOR COLOR CHANGING FIXTURES



**GLASS TOUCH WALL CONTROLLERS**  
Part No.: AWCRGBWWBK  
AWCVWBK



**1 ZONE WALL CONTROLLER**  
Part No.: DMXCTRLG



**5 ZONE WALL CONTROLLER**  
Part No.: DMXCTRL



**10 ZONE WALL CONTROLLER**  
Part No.: DMXCTRLD



**2 UNIVERSE DMX CONTROLLER**  
Part No.: DMXCTRLDR2U  
**6 UNIVERSE DMX CONTROLLER**  
Part No.: DMXCTRLDR6U



**VARIABLE WHITE DIMMER**  
Part No.: RFDIMVWH (White)  
RFDIMWBK (Black)



**WARM DIM DIMMER**  
Part No.: RFDIMWDWH (White)  
RFDIMWDBK (Black)



**4 CHANNEL WATERPROOF DMX INTERFACE**  
Part No.: DMXINFWLCD4



**5 CHANNEL DMX INTERFACE**  
Part No.: DMXINFOLED5



**DMX OPTO SPLITTER**  
Part No.: DMXOS8

DRIVER AND RIBBONLYTE AT FULL LOAD

Wattages	30		60		96		150		200		240		300		320	
	Feet	Meters	Feet	Meters	Feet	Meters	Feet	Meters	Feet	Meters	Feet	Meters	Feet	Meters	Feet	Meters
24 AWG / 0.25 mm <sup>2</sup>	14	4.27	9	2.74	5.5	1.68	3.75	1.14	2.75	0.84	2.25	0.69	1.75	0.53	1.75	0.53
22 AWG / 0.34 mm <sup>2</sup>	22	6.71	14	4.27	9	2.74	5.75	1.75	4.5	1.37	3.5	1.07	2.75	0.84	2.75	0.84
20 AWG / 0.5 mm <sup>2</sup>	35	10.67	23	7.01	14	4.27	9	2.74	7	2.13	5.75	1.75	4.5	1.37	4.25	1.30
18 AWG / 0.75 mm <sup>2</sup>	56	17.07	37	11.28	23	7.01	15	4.57	11	3.35	9	2.74	7.5	2.29	7	2.13
16 AWG / 1.5 mm <sup>2</sup>	90	27.44	60	18.29	37	11.28	24	7.32	18	5.49	15	4.57	12	3.66	11	3.35
14 AWG / 2.5 mm <sup>2</sup>	142	43.29	95	28.96	59	17.99	38	11.59	28	8.54	23	7.01	19	5.79	17	5.18
12 AWG / 4 mm <sup>2</sup>	226	68.90	151	46.04	94	28.66	60	18.29	45	13.72	37	11.28	30	9.15	28	8.54
10 AWG / 6 mm <sup>2</sup>	360	109.76	240	73.17	150	45.73	96	29.27	72	21.95	60	18.29	48	14.63	45	13.72
8 AWG / 10 mm <sup>2</sup>	574	175.00	381	116.16	239	72.87	153	46.65	115	35.06	95	28.96	76	23.17	71	21.65



WIRING DIAGRAMS - STATIC WHITE / STATIC COLOR / RGBW / RGBA / RGBWW

0-10 V

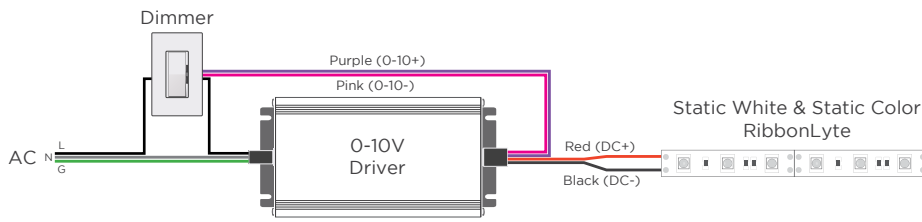

MLV / ELV

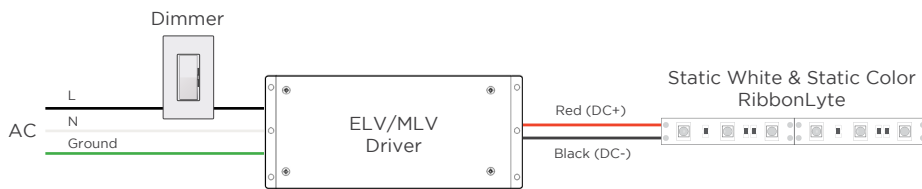

DMX WIRING WITH STATIC WHITE & STATIC COLOR RIBBONLYTE

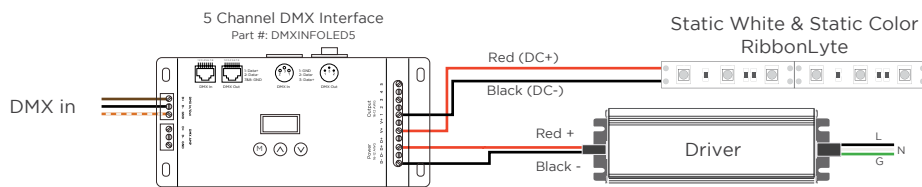

DALI-2 WIRING WITH STATIC WHITE & STATIC COLOR RIBBONLYTE

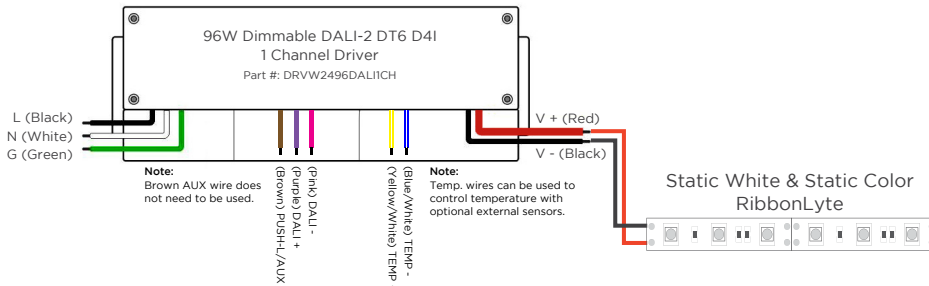

STATIC WHITE & STATIC COLOR RIBBONLYTE WIRING WITH ATHENA WIRELESS COMPATIBLE DRIVER

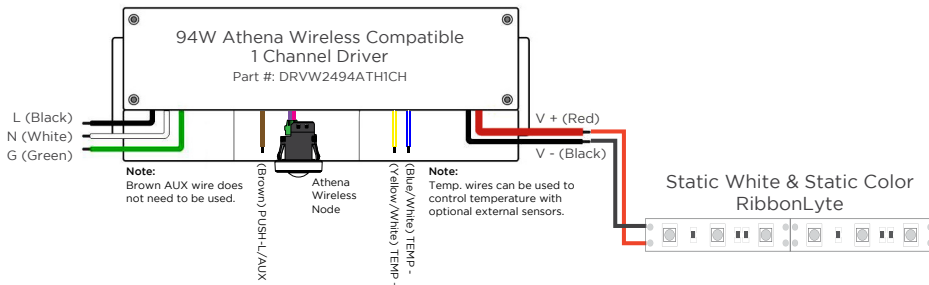

DMX WITH RGBWW 5-IN-1 RIBBONLYTE

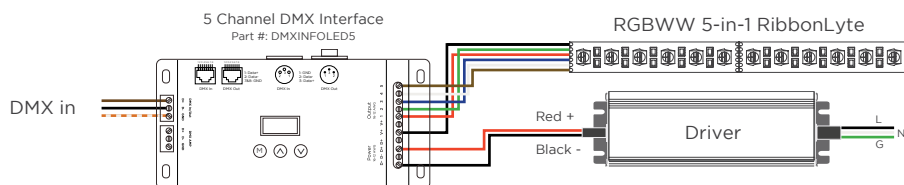

WIRE COLORS PER RIBBONLYTE COLOR

STATIC WHITE + STATIC COLOR

- Red Wire (+) Positive
- Black Wire (-) Negative

RGBW + RGBA

- Black Wire (+) Positive
- Green Wire (-) goes to Green Channel
- Red Wire (-) goes to Red Channel
- Blue Wire (-) goes to Blue Channel
- White Wire (-) goes to White Channel

RGBWW

- Black (+) Positive
- Green Wire (-) goes to Green Channel
- Red Wire (-) goes to Red Channel
- Blue Wire (-) goes to Blue Channel
- White Wire (-) goes to White Channel 1
- Brown Wire (-) goes to White Channel 2

WIRING DIAGRAMS - VARIABLE WHITE

2-CHANNEL VARIABLE WHITE DIMMING

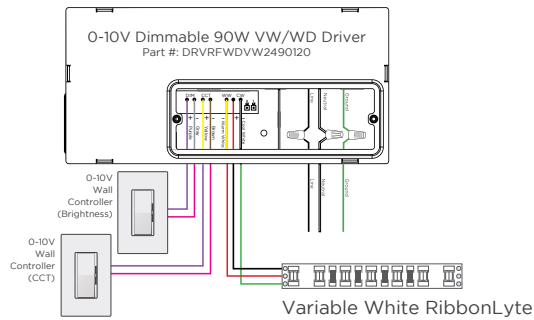

WIRE COLORS PER RIBBONLYTE COLOR

**VARIABLE WHITE**  
Black Wire (+) Positive  
Red Wire (-) goes to Warm White Channel  
Green Wire (-) goes to Cool White Channel

DMX WIRING WITH VARIABLE WHITE RIBBONLYTE

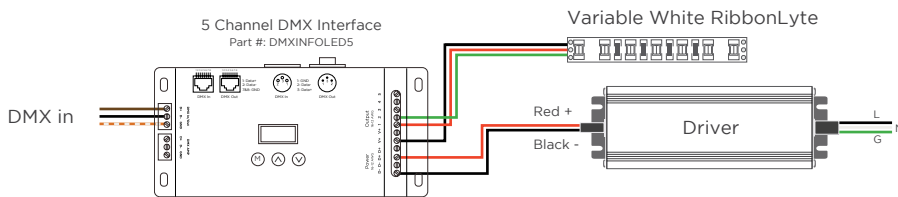

DALI-2 WIRING WITH VARIABLE WHITE RIBBONLYTE

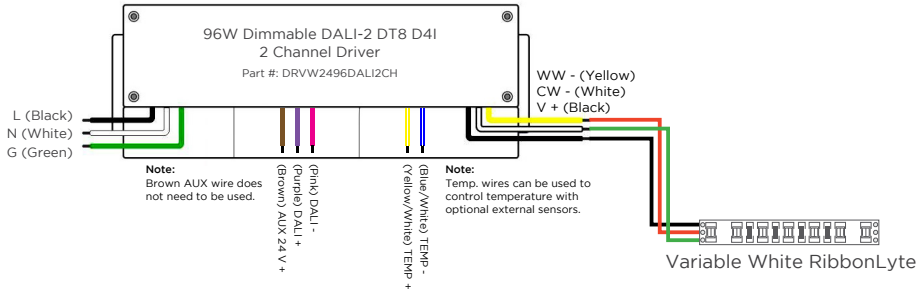

VARIABLE WHITE RIBBONLYTE WIRING WITH ATHENA WIRELESS COMPATIBLE DRIVER

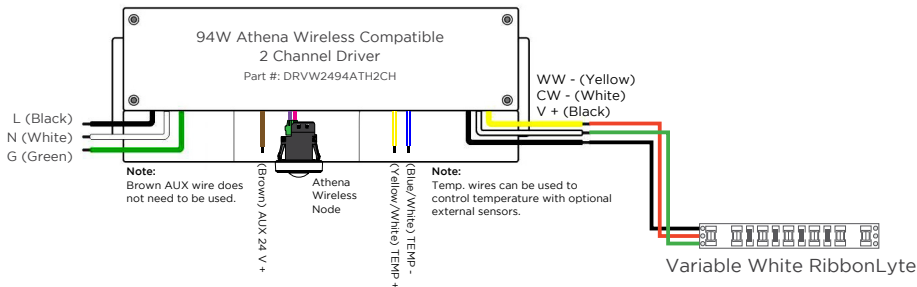

WIRING DIAGRAMS WITH RGBW ADDRESSABLE RIBBONLYTE

One DMX Universe consists of 128 addresses and 512 channels (42 ft, 8 in. of RibbonLyte).

Any single run of RibbonLyte that is less than 16 ft, 4 in. can be wired directly to the controller.

For additional runs, Opto Splitter must be used. Each individual run will need its own Opto Splitter output.

WIRE INDEX	
+	(24V +)
PI	(DMX GND)
A+	(DMX +)
B-	(DMX -)
GND	(24V -)

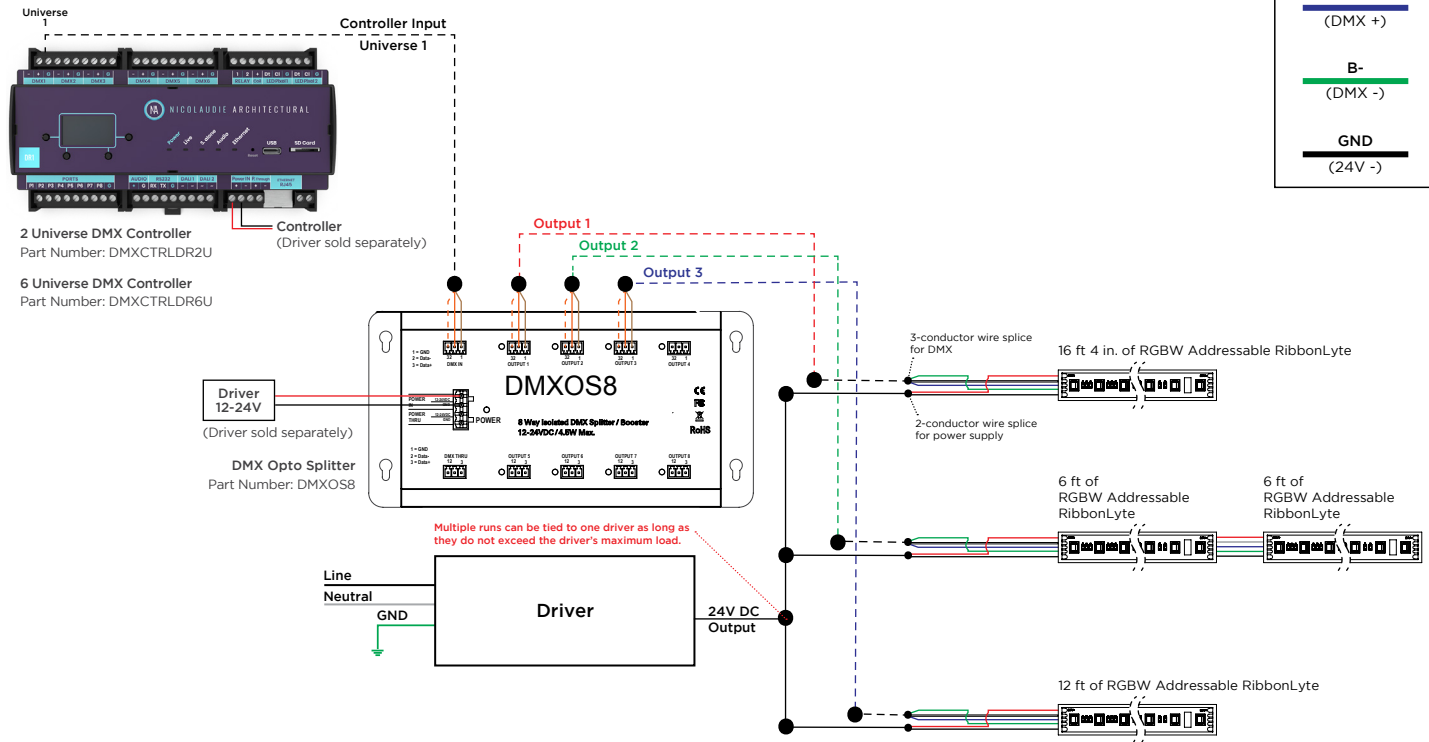

REV.27NOV2024

**GLOBAL HQ**

320 Murray Hill Pkwy  
East Rutherford, NJ 07073  
U.S.  
T: (+1) 212 629 6830  
E: Sales-US@GENLEDBrands.com

**EUROPEAN HQ**

Hogeweyselaan 119  
1382 JK Weesp  
Netherlands  
T: (+31) 346 235 000  
E: SalesEurope@GENLEDBrands.com

**MEINA HQ**

PO Box 371378, #823, Building 4EA  
Dubai Airport Free Zone  
Dubai, UAE  
T: (+971) 4 701 7901  
E: SalesMEINA@genlebrands.com

**ASIA-PACIFIC HQ**

Room 402, Building D  
Shenshi Tongchuang Science and Technology Park  
No. 16 Hongyin Road  
Xingqiang Community, Xinhui Street  
Guangming District, Shenzhen, China 518107  
Sales: (+86) 139 1836 3905  
Office: (+86) 755 8529 0710  
E: Sales-Pacific@GENLEDBrands.com