

AS53 CHANNEL FIXTURE

AS53 channel fixture is a surface-mounted aluminum extrusion that features a large square profile. Create a custom fixture with AS53 and any of our RibbonLyte products, from Static White to Addressable RGBW. Choose from our unique textured narrow and wide prismatic diffusers or a Milky lens for a distinct look.

- 2.09 in. (53 mm) wide by 2.09 in. (53 mm) deep
- Beam angles: 50°x100° with Narrow Prismatic Lens, 85°x100° with Wide Prismatic Lens, 100° with Milky Lens
- Wattage Range from 3 W/ft (9.8 W/m) to 12 W/ft (39.4 W/m)
- Static White delivered lumen range: 193 lm/ft (635 lm/m) up to 1246 lm/ft (4087 lm/m)
- Narrow Prismatic Lens, Wide Prismatic Lens or Milky Lens

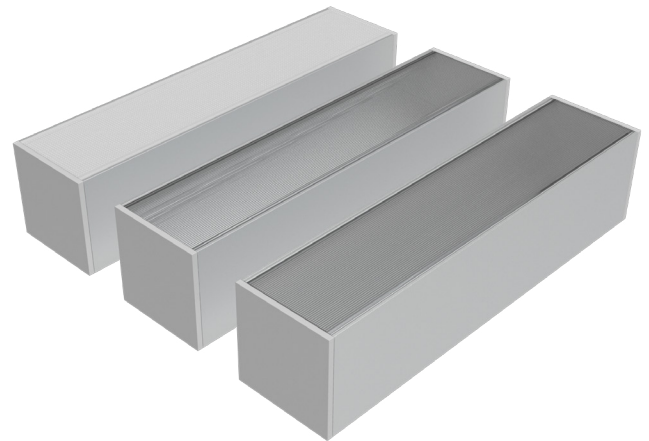

HOUSING FINISHES



*Additional fee applies

LENS FINISHES (PRISMATIC LENSES FOR GLARE REDUCTION)

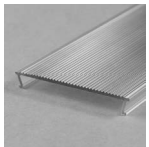

Narrow Prismatic Lens
88% Light Transmission

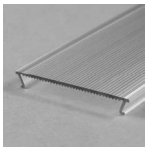

Wide Prismatic Lens
88% Light Transmission

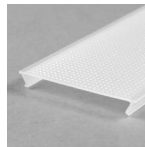

Milky Lens
92% Light Transmission



AVAILABLE COLORS & COLOR TEMPERATURES

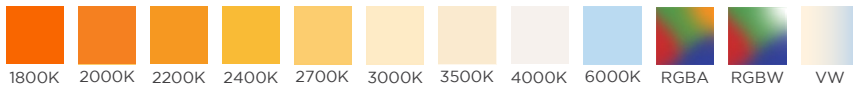

DIMENSIONS

AS53 Channel

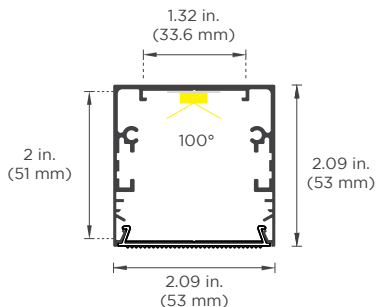

Width: 2.09 in. (53 mm)
Height: 2.09 in. (53 mm)
Internal Width: 1.32 in. (33.6 mm)
Internal Height: 2 in. (51 mm)

Note:

1. This channel does not require mounting clips. Please see our installation guide for instructions.
2. **Exterior channel applications** should be securely attached to the mounting surface with appropriate screws and/or liquid nails. Acolyte strongly recommends field assembly for exterior applications.

Acolyte does not warrant or represent that the information is free from errors or omission. The information may change without notice and Acolyte is not in any way liable for the accuracy of any information printed and stored or in any way interpreted or used.

SPECIFICATIONS

Beam Angle	50°x100° with Narrow Prismatic Lens, 85°x100° with Wide Prismatic Lens, 100° with Milky Lens
Lens Type	Narrow Prismatic Lens, Wide Prismatic Lens, Milky Lens
Length	Channel is sold by the foot and cut to your exact desired length.
Operating Voltage	24V
Dimming	MLV / 0-10 Volt / ELV / DALI / DMX
Operating Temperature	-40° F to 158° F (-40° C to 70° C)
Colors	1800K, 2000K, 2200K, 2400K, 2700K, 3000K, 3500K, 4000K, 6000K, RGBA, RGBW, VW
CRI	90+ CRI (Static white only)
Lamp Life	L70 at 50,000 Hours
MacAdam Ellipses (SDCM)	2-Step Binning (For Static White LEDs only)
Certifications	UL Listed UL 2108 Issued: 2004/02/27 Ed: 1 Rev: 2014/02/24 Low Voltage Lighting Systems CSA C22.2#9.0 Issued: 1996/06/01 Ed: 1 (R2011) General Requirements for Luminaires; with Gen. Inst. 1: 1997, Gen Inst. 2: 1998. ROHS compliant

ACCESSORIES

End Caps

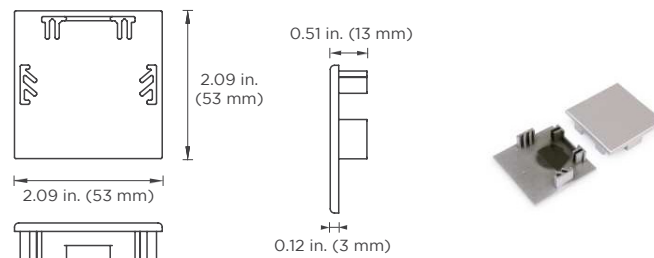

ORDERING GUIDE

STEP 1 Complete Channel Part Number

CHANNEL	LENS	HOUSING COLOR
CHAS53		
CHAS53 - AS53 Channel	NP - Narrow Prismatic Lens WP - Wide Prismatic Lens M - Milky Lens	SV - Silver WH - White BK - Black Consult factory for custom colors

STEP 2 Complete RibbonLyte Part Number

CATEGORY	CRI	RIBBON TYPE & IP RATING
RB		
RB - RibbonLyte	0 - Static Color, Color Changing 90 - 90+ CRI Static White	SWDR20 - Static White Double Row IP20 RGBWADR20 - RGBW/A Double Row IP20 VWDR20 - Variable White Double Row IP20

WATTAGE	COLOR
3.0 - 3.0 W/ft (9.8 W/m - Static White, Variable White, RGBW, RGBA)	18 - 1800K 20 - 2000K 22 - 2200K 24 - 2400K 27 - 2700K 30 - 3000K 35 - 3500K 40 - 4000K 60 - 6000K
6.0 - 6.0 W/ft (19.7 W/m - Static White, Variable White, RGBW, RGBA)	VW - Variable White RGB27 - Red, Green, Blue + 2700K RGB30 - Red, Green, Blue + 3000K RGB40 - Red, Green, Blue + 4000K RGB60 - Red, Green, Blue + 6000K RGBA - Red, Green, Blue + Amber Z - Undecided**
12.0 - 12.0 W/ft (39.4 W/m - Static White, Variable White, RGBW, RGBA)	** For quotes only. Must be chosen before final order.

CONNECTION OPTIONS (See diagrams on the right)

- | | |
|------------------------------------|-------------------------------------|
| 1 - End Feed Bare Wire Connection | 4 - End Feed with IP67 Male Coupler |
| 2 - Back Feed Bare Wire Connection | 5 - Soldered Daisy Chain |
| 3 - Side Feed Bare Wire Connection | 6 - Daisy Chain With IP67 Couplers |

Custom Length (ft.)

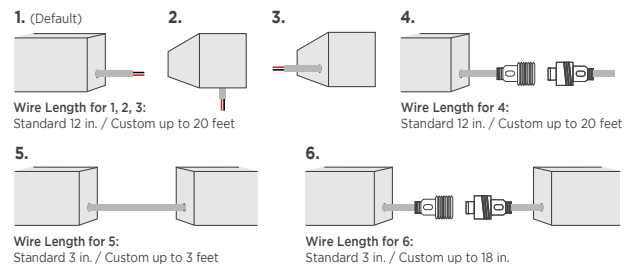

RIBBONLYTE SPECIFICATIONS & COMPATIBILITY

Available Wattages	Cuttable Length	LED Pitch	Color Temp.	lm/W without Lens	Delivered Lumens with Narrow Prismatic Lens (lm/ft / lm/m)	Delivered Lumens with Wide Prismatic Lens (lm/ft / lm/m)	Delivered Lumens with Milky Lens (lm/ft / lm/m)	Max Length	Compatible with Channel		
									IP20	IP65	IP68
3.0 Static White Double Row	0.7 in. (17.9 mm)	136 LEDs/ft (448 LEDs/m)	1800K	73	193 / 635	193 / 635	202 / 662	65 ft 7 in. (20 m)	✓	N/A	N/A
			2000K	86	228 / 749	228 / 749	238 / 781				
			2200K	94	249 / 818	249 / 818	260 / 853				
			2400K	97	256 / 841	256 / 841	267 / 877				
			2700K	109	289 / 948	289 / 948	301 / 989				
			3000K	118	312 / 1024	312 / 1024	326 / 1069				
			3500K	119	315 / 1032	315 / 1032	328 / 1077				
			4000K	118	312 / 1024	312 / 1024	326 / 1069				
6000K	114	303 / 994	303 / 994	316 / 1037							
6.0 Static White Double Row	0.7 in. (17.9 mm)	136 LEDs/ft (448 LEDs/m)	1800K	73	387 / 1269	387 / 1269	403 / 1324	39 ft (12 m)	✓	N/A	N/A
			2000K	86	457 / 1498	457 / 1498	476 / 1563				
			2200K	94	499 / 1636	499 / 1636	520 / 1707				
			2400K	97	513 / 1682	513 / 1682	535 / 1754				
			2700K	109	578 / 1896	578 / 1896	603 / 1978				
			3000K	118	624 / 2049	624 / 2049	651 / 2137				
			3500K	119	629 / 2064	629 / 2064	656 / 2153				
			4000K	118	624 / 2049	624 / 2049	651 / 2137				
6000K	114	606 / 1988	606 / 1988	632 / 2073							
12.0 Static White Double Row	0.7 in. (17.9 mm)	136 LEDs/ft (448 LEDs/m)	1800K	69	734 / 2409	734 / 2409	766 / 2513	26 ft 3 in. (8 m)	✓	N/A	N/A
			2000K	82	867 / 2844	867 / 2844	904 / 2967				
			2200K	89	947 / 3106	947 / 3106	987 / 3239				
			2400K	92	973 / 3193	973 / 3193	1015 / 3330				
			2700K	104	1097 / 3599	1097 / 3599	1144 / 3754				
			3000K	112	1185 / 3889	1185 / 3889	1236 / 4057				
			3500K	113	1194 / 3918	1194 / 3918	1246 / 4087				
			4000K	112	1185 / 3889	1185 / 3889	1236 / 4057				
6000K	109	1150 / 3773	1150 / 3773	1200 / 3936							
3.0 Variable White Double Row	1.97 in. (50 mm)	84 LEDs/ft (280 LEDs/m)	2000K + 6500K	87	230 / 755	230 / 755	240 / 788	65 ft 7 in. (20 m)	✓	N/A	N/A
6.0 Variable White Double Row	1.97 in. (50 mm)	84 LEDs/ft (280 LEDs/m)	2000K + 6500K	82	434 / 1424	434 / 1424	453 / 1485	45 ft 11 in. (14 m)	✓	N/A	N/A
12.0 Variable White Double Row	1.97 in. (50 mm)	84 LEDs/ft (280 LEDs/m)	2000K + 6500K	71	751 / 2466	751 / 2466	784 / 2572	22 ft 11 in. (7 m)	✓	N/A	N/A

RIBBONLYTE SPECIFICATIONS & COMPATIBILITY

Available Wattages	Cuttable Length	LED Pitch	Color Temp.	lm/W without Lens	Delivered Lumens with Narrow Prismatic Lens (lm/ft / lm/m)	Delivered Lumens with Wide Prismatic Lens (lm/ft / lm/m)	Delivered Lumens with Milky Lens (lm/ft / lm/m)	Max Length	Compatible with Channel		
									IP20	IP65	IP68
3.0 RGBW Double Row	1.3 in. (33 mm)	72 LEDs/ft (240 LEDs/m)	RGBW	91	241 / 790	241 / 790	251 / 824	26 ft 3 in. (8 m)	✓	N/A	N/A
3.0 RGBA Double Row	1.3 in. (33 mm)	72 LEDs/ft (240 LEDs/m)	RGBA	78	836 / 2743	836 / 2743	872 / 2862	26 ft 3 in. (8 m)	✓	N/A	N/A
6.0 RGBW Double Row	1.3 in. (33 mm)	72 LEDs/ft (240 LEDs/m)	RGBW	91	482 / 1580	482 / 1580	502 / 1648	22 ft 11 in. (7 m)	✓	N/A	N/A
6.0 RGBA Double Row	1.3 in. (33 mm)	72 LEDs/ft (240 LEDs/m)	RGBA	80	211 / 693	211 / 693	221 / 724	22 ft 11 in. (7 m)	✓	N/A	N/A
12.0 RGBW Double Row	1.3 in. (33 mm)	72 LEDs/ft (240 LEDs/m)	RGBW	79	836 / 2743	836 / 2743	872 / 2862	14 ft 9 in. (4.5 m)	✓	N/A	N/A
12.0 RGBA Double Row	1.3 in. (33 mm)	72 LEDs/ft (240 LEDs/m)	RGBA	75	396 / 1299	396 / 1299	414 / 1358	14 ft 9 in. (4.5 m)	✓	N/A	N/A

DIODE VISIBILITY CHART (Data below applies to installations with Milky lens only)

 No Visible Diode = N		 With Visible Diode = Y	
Static White		Color Changing	
3.0/6.0/12.0 Double Row	IP20	3.0/6.0/12.0 RGBW/A Double Row	3.0/6.0/12.0 Variable White Double Row
N	N	N	N

AVAILABLE DRIVERS / CONTROLLERS AND DIMMING OPTIONS / WIRE GAUGE CHART

NON-DIMMING ELECTRONIC DRIVERS

ELV & MLV DRIVERS



30W, 60W, 96W
Non-Dimming Electronic
Class 2 Drivers

Part No.:
• DRVW2430 (30 Watt)
• DRVW2460 (60 Watt)
• DRVW2496 (96 Watt)
Output Voltage: 24 V
Voltage Range: 120-277 VAC
IP Rating: Dry or Damp
UL Listed



240W, 320W
Non-Dimming
Electronic Drivers

Part No.:
• DRVW24240 (240 Watt)
• DRVW24320 (320 Watt)
Output Voltage: 24 V
Voltage Range: 90-305 VAC
IP Rating: Dry or Damp
UL Recognized



60W, 96W, 150W, 300W, 600W
ELV/MLV Dimmable Drivers

Part No.:
• DRVW2460ELVMLV (60 Watt)
• DRVW2496ELVMLV (96 Watt)
• DRVW24150ELVMLV (150 Watt)
• DRVW24300ELVMLV (300 Watt)
Line Voltage Dimmable Drivers
Output Voltage: 24 V
Voltage Range: 100-277 VAC
IP Rating: IP67
UL, CE, and CSA Listed

0-10V DRIVERS



0-10V Dimmable Waterproof Drivers

96W Part No.: DRVW249610P
288W Part No.: DRVW2428810P
Output Voltage: 24 V (+/- 0.5V)
Voltage Range: 100-277 VAC
Environmental Rating: UL Wet Location
UL Listed



0-10V Dimmable 90W VW/WD Driver

Part No.: DRVRFWDVW2490120

DMX CONTROLLER AND PART NUMBER - FOR COLOR CHANGING VERSIONS



GLASS TOUCH WALL CONTROLLERS
Part Number: AWCRGBWBK
AWCVWBK



1 ZONE WALL CONTROLLER
Part Number: DMXCTRLG



5 ZONE WALL CONTROLLER
Part Number: DMXCTRL



10 ZONE WALL CONTROLLER
Part Number: DMXCTRLD

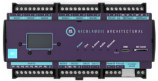

2 UNIVERSE DMX CONTROLLER
Part Number: DMXCTRLDR2U



4 CHANNEL WATERPROOF DMX INTERFACE
Part Number: DMXINFWLCD4



5 CHANNEL DMX INTERFACE
Part Number: DMXINFOLED5



DMX OPTO SPLITTER
Part Number: DMXOS8

6 UNIVERSE DMX CONTROLLER
Part Number: DMXCTRLDR6U

DRIVER AND RIBBONLYTE AT FULL LOAD

Wattages	30		60		96		150		200		240		300		320		
	Wire Gauge	Feet	Meters	Feet	Meters	Feet	Meters	Feet	Meters	Feet	Meters	Feet	Meters	Feet	Meters	Feet	Meters
24 AWG / 0.25 mm ²	14	4.27	9	2.74	5.5	1.68	3.75	1.14	2.75	0.84	2.25	0.69	1.75	0.53	1.75	0.53	
22 AWG / 0.34 mm ²	22	6.71	14	4.27	9	2.74	5.75	1.75	4.5	1.37	3.5	1.07	2.75	0.84	2.75	0.84	
20 AWG / 0.5 mm ²	35	10.67	23	7.01	14	4.27	9	2.74	7	2.13	5.75	1.75	4.5	1.37	4.25	1.30	
18 AWG / 0.75 mm ²	56	17.07	37	11.28	23	7.01	15	4.57	11	3.35	9	2.74	7.5	2.29	7	2.13	
16 AWG / 1.5 mm ²	90	27.44	60	18.29	37	11.28	24	7.32	18	5.49	15	4.57	12	3.66	11	3.35	
14 AWG / 2.5 mm ²	142	43.29	95	28.96	59	17.99	38	11.59	28	8.54	23	7.01	19	5.79	17	5.18	
12 AWG / 4 mm ²	226	68.90	151	46.04	94	28.66	60	18.29	45	13.72	37	11.28	30	9.15	28	8.54	
10 AWG / 6 mm ²	360	109.76	240	73.17	150	45.73	96	29.27	72	21.95	60	18.29	48	14.63	45	13.72	
8 AWG / 10 mm ²	574	175.00	381	116.16	239	72.87	153	46.65	115	35.06	95	28.96	76	23.17	71	21.65	

WIRING DIAGRAMS

0-10V

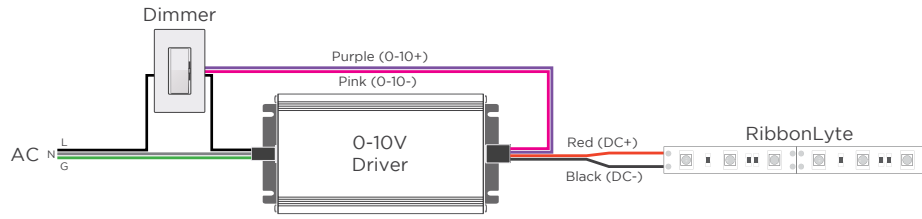

MLV / ELV

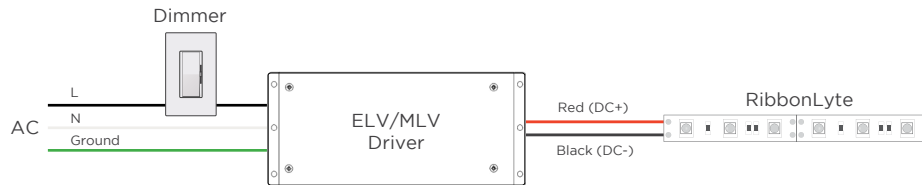

DMX

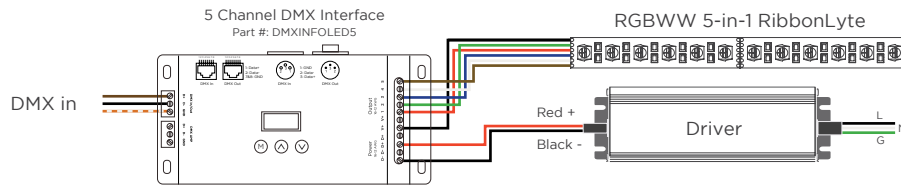

WARM DIM

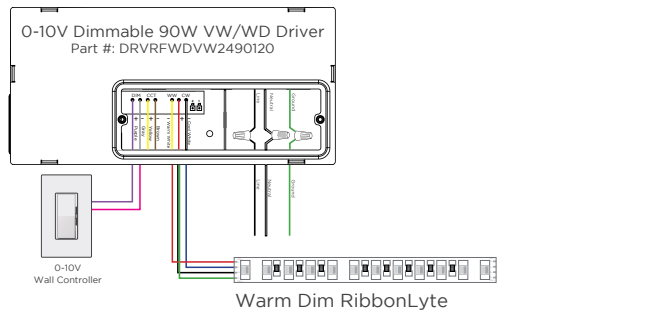

2-CHANNEL VARIABLE WHITE DIMMING

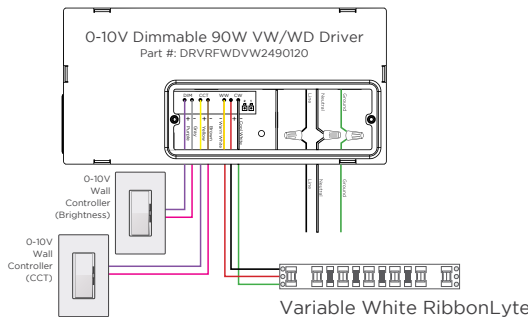

DMX WIRING DIAGRAM - COMPATIBLE WITH ALL MODELS OF VARIABLE WHITE RIBBONLYTE

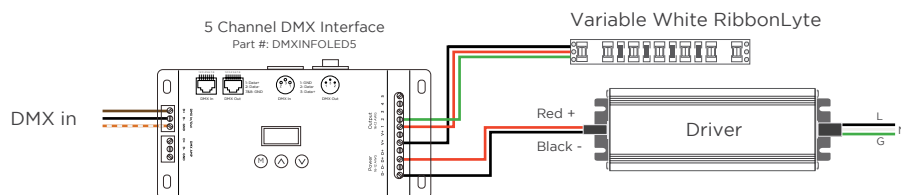

WIRE COLORS PER RIBBONLYTE COLOR

STATIC WHITE + STATIC COLOR

Red Wire (+) Positive
Black Wire (-) Negative

RGBW + RGBA

Black Wire (+) Positive
Green Wire (-) goes to Green Channel
Red Wire (-) goes to Red Channel
Blue Wire (-) goes to Blue Channel
White Wire (-) goes to White Channel

RGBWW

Black (+) Positive
Green Wire (-) goes to Green Channel
Red Wire (-) goes to Red Channel
Blue Wire (-) goes to Blue Channel
White Wire (-) goes to White Channel 1
Brown Wire (-) goes to White Channel 2

WARM DIM

Red Wire (-) goes to Warm White Channel
Blue Wire (-) goes to Cool White Channel
Black Wire (+) goes to Warm White Channel
Green Wire (+) goes to Cool White Channel

VARIABLE WHITE

Black Wire (+) Positive
Red Wire (-) goes to Warm White Channel
Green Wire (-) goes to Cool White Channel