

### AW12 CHANNEL FIXTURE

AW12 Channel is a slanted aluminum extrusion that mounts directly to the wall or ceiling, allowing you to create unique cove lighting with hidden wiring. Cast light up, down or sideways! For outdoor use with appropriate RibbonLyte. Create a custom fixture with AW12 Channel and RibbonLyte products.

- Available for field assembly or factory assembly
- 0.91 in. (23 mm) wide by 2.17 in. (55 mm) deep
- Beam angle: 100°
- Wattage Range from 0.75 W/ft (2.46 W/m) to 8.8 W/ft (28.9 W/m)
- Static White delivered lumen range from 44 lm/ft (145 lm/m) up to 737 lm/ft (2417 lm/m)
- Clear, Milky or Black lens

### HOUSING FINISHES



Silver Standard White\* Custom RAL\*

\*Additional fee applies

### LENS FINISHES



Clear Lens 93% Light Transmission Milky Lens 75% Light Transmission Black Lens\* 70% Light Transmission

\* Our black lens offers great diffusion and helps hide fixtures that aren't in use.

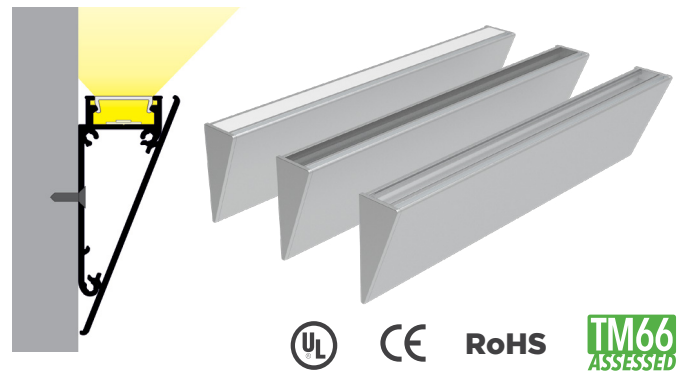

### AVAILABLE COLORS & COLOR TEMPERATURES

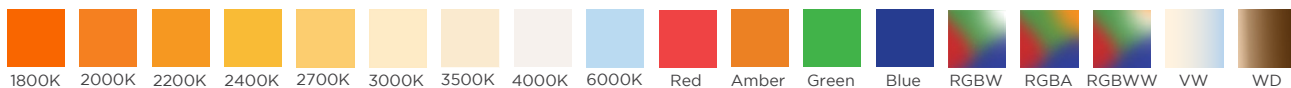

### DIMENSIONS

#### AW12 Channel

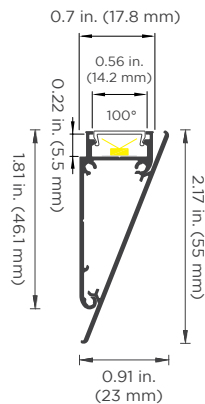

Width: 0.91 in. (23 mm)  
Height: 2.17 in. (55 mm)  
Internal Width: 0.56 in. (14.2 mm)  
Internal Height: 0.22 in. (5.5 mm)

#### Note:

1. This channel does not require mounting clips. Please see our installation guide for instructions.
2. **Exterior channel applications** should be securely attached to the mounting surface with appropriate screws and/or liquid nails. Acolyte strongly recommends field assembly for exterior applications.

Acolyte does not warrant or represent that the information is free from errors or omission. The information may change without notice and Acolyte is not in any way liable for the accuracy of any information printed and stored or in any way interpreted or used.

**SPECIFICATIONS**

<b>Beam Angle</b>	100°
<b>Lens Type</b>	Clear Lens, Milky Lens, Black Lens
<b>Length</b>	Channel is sold by the foot and cut to your exact desired length.
<b>Operating Voltage</b>	24V
<b>Dimming</b>	MLV / 0-10 Volt / ELV / DALI / DMX
<b>Operating Temperature</b>	-40° F to 158° F (-40° C to 70° C)
<b>Colors</b>	1800K, 2000K, 2200K, 2400K, 2700K, 3000K, 3500K, 4000K, 6000K, Red, Amber, Green, Blue, RGBW, RGBWW, RGBA, VW, Warm Dim (1800K, 2000K, 2200K only available in IP20)
<b>CRI</b>	90+ CRI (Static white only)
<b>Lamp Life</b>	L70 at 50,000 Hours
<b>MacAdam Ellipses (SDCM)</b>	2-Step Binning (For Static White LEDs only)
<b>Certifications</b>	UL Listed UL 2108 Issued: 2004/02/27 Ed: 1 Rev: 2014/02/24 Low Voltage Lighting Systems CSA C22.2#9.0 Issued: 1996/06/01 Ed: 1 (R2011) General Requirements for Luminaries; with Gen. Inst. 1: 1997, Gen Inst. 2: 1998. ROHS compliant

**ACCESSORIES**

**180° Coupler (Part #: CHCOUP180AW12)**

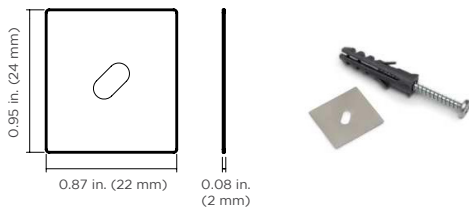

**End Caps**

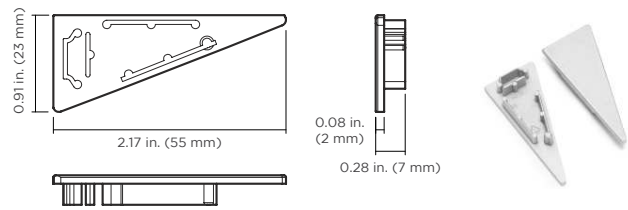

ORDERING GUIDE

**STEP 1 Complete Channel Part Number**

CHANNEL	LENS	HOUSING COLOR
CHAW12		
CHAW12 - AW12 Channel	C - Clear Lens      BK - Black Lens M - Milky Lens	SV - Silver      Consult factory for custom colors WH - White

**STEP 2 Complete RibbonLyte Part Number**

CATEGORY	CRI	RIBBON TYPE & IP RATING
RB		
RB - RibbonLyte	0 - Static Color, Color Changing 90 - 90+ CRI Static White	LINEA20 - Linea RibbonLyte IP20      RGBW20 - RGBWW 5-in-1 IP20      VWS220 - VW Series 2 IP20 SWS220 - Static White Series 2 IP20      RGBWS220 - RGBW Series 2 IP20      VWS265 - VW Series 2 IP65 SWS265 - Static White Series 2 IP65      RGBWS265 - RGBW Series 2 IP65      WD20 - Warm Dim IP20 SCS220 - Static Color Series 2 IP20      VWS220 - VW Series 2 IP20      WD65 - Warm Dim IP65 SCS265 - Static Color Series 2 IP65      VWS265 - VW Series 2 IP65

**NOTE:** To ensure waterproofing standards are met, IP65 RibbonLyte can NOT be cut in the field.

WATTAGE
0.75 - 0.75 W/ft (2.46 W/m - Static White, Static Color)
1.0 - 1.0 W/ft (3.3 W/m - Variable White)
1.5 - 1.5 W/ft (4.9 W/m - Static White, Static Color)
2.2 - 2.2 W/ft (7.2 W/m - Static White, Static Color)
2.4 - 2.4 W/ft (8 W/m - Static White)
3.0 - 3.0 W/ft (9.8 W/m - Static White, Static Color, Variable White)
4.3 - 4.3 W/ft (14 W/m - Static White)
4.4 - 4.4 W/ft (14.4 W/m - Static White, Static Color, RGBW, RGBWW, RGBA)
5.2 - 5.2 W/ft (17.1 W/m - Warm Dim)
5.0 - 5.0 W/ft (16.4 W/m - Static White, Static Color)
5.5 - 5.5 W/ft (18.0 W/m - RGBW, RGBA)
6.0 - 6.0 W/ft (19.7 W/m - Static White, Static Color, Variable White)
6.1 - 6.1 W/ft (20 W/m - Variable White)
8.8 - 8.8 W/ft (28.86 W/m - RGBW, RGBWW, RGBA)

COLOR
18 - 1800K
20 - 2000K
22 - 2200K
24 - 2400K
27 - 2700K
30 - 3000K
35 - 3500K
40 - 4000K
60 - 6000K
R - Red
A - Amber
G - Green
B - Blue
RGB27 - Red, Green, Blue + 2700K
RGB30 - Red, Green, Blue + 3000K
RGB40 - Red, Green, Blue + 4000K
RGB2465 - Red, Green, Blue + 2400K + 6500K
RGBA - Red, Green, Blue + Amber
VW - Variable White
2920 - Warm Dim 2900K-2000K (IP20)
2721 - Warm Dim 2900K-2000K (IP65)
Z - Undecided**
** For quotes only. Must be chosen before final order.

CONNECTION OPTIONS (See diagrams on the right)	Custom Length (ft.)
1 - Back Feed Bare Wire Connection      3 - Soldered Daisy Chain	
2 - Back Feed with IP67 Male Coupler      4 - Daisy Chain With IP67 Couplers	

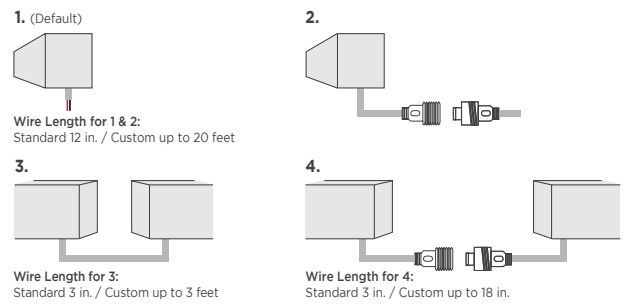

**STEP 3 Complete Assembly Option & Length**

ASSEMBLY OPTION	LENGTH (Standard factory assembled length up to 6 ft 6.7 in. / 2 m)
FI - Field Assembly	
FA - Factory Assembly* (not recommended for exterior applications)	

\* Factory assembled runs exceeding 6 ft 6.7 in. (2 m) will be split into multiple daisy chained fixtures.

**DO NOT BUTT END CAPS AGAINST EACH OTHER WHEN CREATING LONGER FIXTURES**  
Acolyte STRONGLY SUGGESTS field assembly (without using interior end caps) for direct-view fixtures of more than 6 ft 6.7 in. (2 m) in length. Field assembly without interior end caps will eliminate gaps or dead spots that can be caused by butting interior end caps against each other.

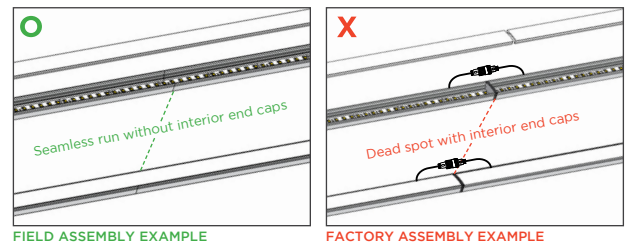

**STEP 4 Add Accessories**

ACCESSORIES
CHCOUP180AW12 - 180° Coupler



**RIBBONLYTE SPECIFICATIONS & COMPATIBILITY**

Available Wattages	Cutttable Length	LED Pitch	Color Temp.	lm/W without Lens	Delivered Lumens with Clear Lens (lm/ft / lm/m)	Delivered Lumens with Milky Lens (lm/ft / lm/m)	Delivered Lumens with Black Lens (lm/ft / lm/m)	Max Length	Compatible with Channel		
									IP20	IP65	IP68
0.75 Static White Series 2	1.97 in. (50 mm)	48 LEDs/ft (160 LEDs/m)	1800K	84	59 / 192	47 / 155	44 / 145	IP20: 49 ft (15 m) IP65: 32.8 ft (10 m)	✓	✓	
			2000K	99	69 / 227	56 / 183	52 / 171				
			2200K	109	76 / 249	61 / 201	57 / 188				
			2400K	113	79 / 259	64 / 209	59 / 195				
			2700K	123	86 / 281	69 / 227	65 / 212				
			3000K	123	86 / 281	69 / 227	65 / 212				
			3500K	130	91 / 297	73 / 240	68 / 224				
			4000K	134	93 / 307	75 / 247	70 / 231				
6000K	131	91 / 300	74 / 242	69 / 226							
1.5 Static White Series 2	1.97 in. (50 mm)	48 LEDs/ft (160 LEDs/m)	1800K	84	117 / 384	95 / 310	88 / 289	IP20: 49 ft (15 m) IP65: 32.8 ft (10 m)	✓	✓	
			2000K	98	137 / 384	110 / 362	103 / 338				
			2200K	109	152 / 499	123 / 402	114 / 375				
			2400K	113	158 / 517	127 / 417	119 / 389				
			2700K	123	172 / 563	138 / 454	129 / 424				
			3000K	123	172 / 563	138 / 454	129 / 424				
			3500K	129	180 / 590	145 / 476	135 / 444				
			4000K	134	187 / 613	151 / 495	141 / 462				
6000K	131	183 / 600	147 / 484	138 / 451							
2.2 Static White Series 2	1.97 in. (50 mm)	48 LEDs/ft (160 LEDs/m)	1800K	83	170 / 557	137 / 449	128 / 419	IP20: 42 ft (12.8 m) IP65: 32.8 ft (10 m)	✓	✓	
			2000K	96	196 / 644	158 / 520	148 / 485				
			2200K	106	217 / 712	175 / 574	163 / 536				
			2400K	111	227 / 745	183 / 601	171 / 561				
			2700K	120	246 / 806	198 / 650	185 / 606				
			3000K	122	250 / 819	201 / 660	188 / 616				
			3500K	127	260 / 852	210 / 687	196 / 642				
			4000K	133	272 / 893	219 / 720	205 / 672				
6000K	128	262 / 859	211 / 693	197 / 647							
3.0 Static White Series 2	1.97 in. (50 mm)	48 LEDs/ft (160 LEDs/m)	1800K	84	234 / 769	189 / 620	176 / 579	IP20: 36 ft (11 m) IP65: 32.8 ft (10 m)	✓	✓	
			2000K	98	273 / 897	221 / 723	206 / 675				
			2200K	108	301 / 989	243 / 797	227 / 744				
			2400K	109.8	306 / 1005	247 / 811	231 / 756				
			2700K	122.9	343 / 1125	277 / 907	258 / 847				
			3000K	130	363 / 1190	293 / 960	273 / 896				
			3500K	133	371 / 1217	299 / 982	279 / 916				
			4000K	133	371 / 1217	299 / 982	279 / 916				
6000K	128	357 / 1172	288 / 945	269 / 882							
4.4 Static White Series 2	1.97 in. (50 mm)	48 LEDs/ft (160 LEDs/m)	1800K	81	331 / 1087	267 / 877	249 / 818	28 ft 4 in. (8.64 m)	✓	✓	
			2000K	95	389 / 1275	314 / 1029	293 / 960				
			2200K	105	430 / 1410	347 / 1137	323 / 1061				
			2400K	109	446 / 1463	360 / 1180	336 / 1101				
			2700K	122	499 / 1638	403 / 1321	376 / 1233				
			3000K	129	528 / 1732	426 / 1397	397 / 1304				
			3500K	132	540 / 1772	436 / 1429	407 / 1334				
			4000K	132	540 / 1772	436 / 1429	407 / 1334				
6000K	126	516 / 1692	416 / 1364	388 / 1273							
5.0 Static White Series 2	1.4 in. (35.7 mm)	68 LEDs/ft (224 LEDs/m)	1800K	83	386 / 1266	311 / 1021	291 / 953	IP20: 33 ft 4 in. (10.1 m) IP65: 32.8 ft (10 m)	✓	✓	
			2000K	98	456 / 1495	368 / 1206	343 / 1125				
			2200K	107	498 / 1632	401 / 1316	375 / 1229				
			2400K	110	511 / 1675	412 / 1351	384 / 1261				
			2700K	123	571 / 1875	461 / 1512	430 / 1411				
			3000K	130	605 / 1983	488 / 1599	455 / 1493				
			3500K	133	618 / 2029	499 / 1636	466 / 1527				
			4000K	133	618 / 2029	499 / 1636	466 / 1527				
6000K	127	591 / 1937	476 / 1562	445 / 1458							
6.0 Static White Series 2	1.4 in. (35.7 mm)	68 LEDs/ft (224 LEDs/m)	1800K	82	458 / 1501	369 / 1211	344 / 1130	28 ft (8.5 m)	✓	✓	
			2000K	95	530 / 1739	428 / 1403	399 / 1309				
			2200K	106	591 / 1941	477 / 1565	445 / 1461				
			2400K	109	608 / 1995	491 / 1609	458 / 1502				
			2700K	122	681 / 2233	549 / 1801	512 / 1681				
			3000K	129	720 / 2362	581 / 1905	542 / 1778				
			3500K	132	737 / 2417	594 / 1949	554 / 1819				
			4000K	132	737 / 2417	594 / 1949	554 / 1819				
6000K	126	703 / 2307	567 / 1860	529 / 1736							

RIBBONLYTE SPECIFICATIONS & COMPATIBILITY

Available Wattages	Cuttable Length	LED Pitch	Color Temp.	lm/W without Lens	Delivered Lumens with Clear Lens (lm/ft / lm/m)	Delivered Lumens with Milky Lens (lm/ft / lm/m)	Delivered Lumens with Black Lens (lm/ft / lm/m)	Max Length	Compatible with Channel		
									IP20	IP65	IP68
0.75 Static Color Series 2	1.97 in. (50 mm)	48 LEDs/ft (160 LEDs/m)	Red	41	29 / 94	23 / 76	22 / 71	IP20: 49 ft (15 m) IP65: 32.8 ft (10 m)	✓	✓	
			Green	175	122 / 400	98 / 323	92 / 301				
			Blue	19	13 / 43	11 / 35	10 / 33				
			Amber	34	24 / 78	19 / 63	18 / 59				
1.5 Static Color Series 2	1.97 in. (50 mm)	48 LEDs/ft (160 LEDs/m)	Red	42	59 / 192	47 / 155	44 / 145	IP20: 49 ft (15 m) IP65: 32.8 ft (10 m)	✓	✓	
			Green	160	223 / 732	180 / 591	168 / 551				
			Blue	18	25 / 82	20 / 66	19 / 62				
			Amber	34	47 / 156	38 / 125	36 / 117				
2.2 Static Color Series 2	1.97 in. (50 mm)	48 LEDs/ft (160 LEDs/m)	Red	42	86 / 282	69 / 227	65 / 212	IP20: 42 ft (12.8 m) IP65: 32.8 ft (10 m)	✓	✓	
			Green	145	297 / 973	239 / 785	223 / 733				
			Blue	18	37 / 121	30 / 97	28 / 91				
			Amber	34	70 / 228	56 / 184	52 / 172				
3.0 Static Color Series 2	1.97 in. (50 mm)	48 LEDs/ft (160 LEDs/m)	Red	40	112 / 366	90 / 295	84 / 267	32.8 ft (10 m)	✓	✓	
			Green	127	354 / 1162	286 / 937	267 / 875				
			Blue	25	70 / 229	56 / 185	53 / 172				
			Amber	29	81 / 265	65 / 214	61 / 200				
4.4 Static Color Series 2	1.97 in. (50 mm)	48 LEDs/ft (160 LEDs/m)	Red	38	155 / 510	125 / 411	117 / 384	29 ft (8.8 m)	✓	✓	
			Green	117	479 / 1571	386 / 1267	360 / 1182				
			Blue	24	98 / 322	79 / 260	74 / 243				
			Amber	25	102 / 336	83 / 271	77 / 253				
5.0 Static Color Series 2	1.4 in. (35.7 mm)	68 LEDs/ft (224 LEDs/m)	Red	37	172 / 564	139 / 455	130 / 425	30 ft (9.14 m)	✓	✓	
			Green	116	539 / 1770	435 / 1427	406 / 1332				
			Blue	24	112 / 366	90 / 295	84 / 276				
			Amber	26	121 / 397	98 / 320	91 / 299				
6.0 Static Color Series 2	1.4 in. (35.7 mm)	68 LEDs/ft (224 LEDs/m)	Red	37	206 / 677	167 / 546	155 / 510	28 ft (8.5 m)	✓	✓	
			Green	113	631 / 2069	509 / 1668	475 / 1557				
			Blue	23	128 / 421	104 / 340	97 / 317				
			Amber	24	134 / 439	108 / 354	101 / 331				
2.4 Static White Linea	1.97 in. (50 mm)	146 LEDs/ft (480 LEDs/m)	2700K	67	149.7 / 491	120.8 / 396	112.7 / 369.6	21.3 ft (6.5 m)	✓	N/A	N/A
			3000K	71	158.1 / 519.9	127.5 / 419.3	119 / 391.3				
			3500K	83	185.1 / 608.2	149.3 / 490.5	139.3 / 457.8				
			4000K	83	185.1 / 608.2	149.3 / 490.5	139.3 / 457.8				
3.0 Static White Linea	1.97 in. (50 mm)	146 LEDs/ft (480 LEDs/m)	2700K	66	184.1 / 604.5	148.5 / 487.5	138.6 / 455	21.3 ft (6.5 m)	✓	N/A	N/A
			3000K	73	203.7 / 668.7	164.3 / 539.3	153.3 / 503.3				
			3500K	78	217.6 / 714.2	175.5 / 576	163.8 / 537.6				
			4000K	83	231.6 / 759.8	186.8 / 612.8	174.3 / 571.9				
4.3 Static White Linea	1.97 in. (50 mm)	146 LEDs/ft (480 LEDs/m)	2700K	75	300.4 / 983.9	242.3 / 793.5	226.1 / 740.6	24.6 ft (7.5 m)	✓	N/A	N/A
			3000K	78	311.6 / 023	251.3 / 825	234.5 / 770				
			3500K	86	344.1 / 129	277.5 / 910.5	259 / 849.8				
			4000K	86	344.1 / 29	277.5 / 910.5	259 / 849.8				
6.1 Variable White Linea	1.09 in. (27.78 mm)	175 LEDs/ft (576 LEDs/m)	2700K + 6500K	95	539.4 / 1769.8	435 / 427.3	406 / 332.1	16.4 ft (5 m)	✓	N/A	N/A

**RIBBONLYTE SPECIFICATIONS & COMPATIBILITY**

Available Wattages	Cuttable Length	LED Pitch	Color Temp.	lm/W without Lens	Delivered Lumens with Clear Lens (lm/ft / lm/m)	Delivered Lumens with Milky Lens (lm/ft / lm/m)	Delivered Lumens with Black Lens (lm/ft / lm/m)	Max Length	Compatible with Channel		
									IP20	IP65	IP68
1.0 Variable White Series 2	1.97 in. (50 mm)	42 LEDs/ft (140 LEDs/m)	2000K + 6500K	85	79 / 259	64 / 209	60 / 195	32.8 ft (10 m)	✓	✓	
3.0 Variable White Series 2	1.97 in. (50 mm)	42 LEDs/ft (140 LEDs/m)	2000K + 6500K	80	223 / 732	180 / 591	168 / 551	32.8 ft (10 m)	✓	✓	
6.0 Variable White Series 2	1.97 in. (50 mm)	42 LEDs/ft (140 LEDs/m)	2000K + 6500K	75	419 / 1373	338 / 1107	315 / 1033	19 ft 8 in. (6 m)	✓	✓	
4.4 RGBW Series 2	1.97 in. (50 mm)	36 LEDs/ft (120 LEDs/m)	RGBW	45	188.1 / 617.2	148.5 / 487.2	138.6 / 454.7	19 ft 8 in. (6 m)	✓	N/A	N/A
5.5 RGBW Series 2	1.97 in. (50 mm)	36 LEDs/ft (120 LEDs/m)	RGBW	59	308.8 / 1013	243.3 / 798.5	227.2 / 745.3	IP65: 16 ft 4 in. (5 m) IP68: 19 ft 7.9 in. (6 m)	N/A	✓	
8.8 RGBW Series 2	1.97 in. (50 mm)	36 LEDs/ft (120 LEDs/m)	RGBW	61	510.2 / 1673.8	402.6 / 1320.9	375.8 / 1232.9	16 ft 4 in. (5 m)	✓	N/A	N/A
4.4 5-in-1 RGBWW	2.46 in. (62.5 mm)	29 LED/ft (96 LED/m)	RGBWW	59	241.4 / 792.1	194.7 / 638.8	181.7 / 596.2	16 ft 4 in. (5 m)	✓	N/A	N/A
8.8 5-in-1 RGBWW	2.46 in. (62.5 mm)	29 LED/ft (96 LED/m)	RGBWW	50	409.2 / 1342.6	330.0 / 1082.7	308.0 / 1010.5	11 ft 6 in. (3.5 m)	✓	N/A	N/A
5.2 Warm Dim	3.94 in. (100 mm)	36 LEDs/ft (120 LEDs/m)	WARM DIM	55	266 / 873	215 / 704	200 / 657	16 ft 4 in. (5 m)	✓	✓	

**DIODE VISIBILITY CHART** (Data below applies to installations with Milky lens only)

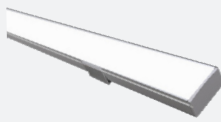
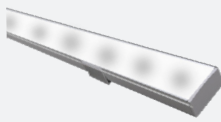
 <b>No Visible Diode = N</b> Note: Linea RibbonLyte has no visible diode			 <b>With Visible Diode = Y</b>						
Static White & Static Color RibbonLyte			Color Changing RibbonLyte						
0.75/1.5/2.2	3.0/4.4	5.0/6.0	4.4 RGBW Series 2	5.5 RGBW Series 2	8.8 RGBW Series 2	4.4 5-in-1 RGBWW	8.8 5-in-1 RGBWW	Warm Dim	Variable White
IP20 IP65	IP20 IP65	IP20 IP65	IP20	IP65	IP20	IP20	IP20	IP20 IP65	IP20 IP65
<b>N</b>	<b>N</b>	<b>N</b>	<b>Y</b>	<b>Y</b>	<b>Y</b>	<b>Y</b>	<b>Y</b>	<b>N</b>	<b>N</b>

AVAILABLE DRIVERS / CONTROLLERS AND DIMMING OPTIONS / WIRE GAUGE CHART

NON-DIMMING ELECTRONIC DRIVERS

ELV & MLV DRIVERS



**30W, 60W, 96W**  
Non-Dimming Electronic  
Class 2 Drivers

Part No.:  
• DRVW2430 (30 Watt)  
• DRVW2460 (60 Watt)  
• DRVW2496 (96 Watt)  
Output Voltage: 24 V  
Voltage Range: 120-277 VAC  
IP Rating: Dry or Damp  
UL Listed



**240W, 320W**  
Non-Dimming  
Electronic Drivers

Part No.:  
• DRVW24240 (240 Watt)  
• DRVW24320 (320 Watt)  
Output Voltage: 24 V  
Voltage Range: 90-305 VAC  
IP Rating: Dry or Damp  
UL Recognized



**60W, 96W, 150W, 300W, 600W**  
ELV/MLV Dimmable Drivers

Part No.:  
• DRVW2460ELVMLV (60 Watt)  
• DRVW2496ELVMLV (96 Watt)  
• DRVW24150ELVMLV (150 Watt)  
• DRVW24300ELVMLV (300 Watt)  
Line Voltage Dimmable Drivers  
Output Voltage: 24 V  
Voltage Range: 100-277 VAC  
IP Rating: IP67  
UL, CE, and CSA Listed

0-10V DRIVERS



**0-10V Dimmable Waterproof Drivers**

**96W** Part No.: DRVW249610P  
**288W** Part No.: DRVW2428810P  
Output Voltage: 24 V (+/- 0.5V)  
Voltage Range: 100-277 VAC  
Environmental Rating: UL Wet Location  
UL Listed



**0-10V Dimmable 90W VW/WD Driver**

Part No.: DRVRFWDVW2490120

DMX CONTROLLER AND PART NUMBER - FOR COLOR CHANGING VERSIONS



**GLASS TOUCH**  
WALL CONTROLLERS  
Part Number: AWCRCBWWBK  
AWCVWBK



**1 ZONE WALL CONTROLLER**  
Part Number: DMXCTRLG



**5 ZONE WALL CONTROLLER**  
Part Number: DMXCTRL



**10 ZONE WALL CONTROLLER**  
Part Number: DMXCTRLD

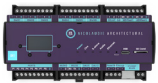

**2 UNIVERSE DMX CONTROLLER**  
Part Number: DMXCTRLDR2U



**4 CHANNEL WATERPROOF**  
DMX INTERFACE  
Part Number: DMXINFWLCD4



**5 CHANNEL**  
DMX INTERFACE  
Part Number: DMXINFOLED5



**DMX OPTO SPLITTER**  
Part Number: DMXOS8

**6 UNIVERSE DMX CONTROLLER**  
Part Number: DMXCTRLDR6U

DRIVER AND RIBBONLYTE AT FULL LOAD

Wattages	30		60		96		150		200		240		300		320		
	Wire Gauge	Feet	Meters	Feet	Meters	Feet	Meters	Feet	Meters	Feet	Meters	Feet	Meters	Feet	Meters	Feet	Meters
24 AWG / 0.25 mm <sup>2</sup>	14	4.27	9	2.74	5.5	1.68	3.75	1.14	2.75	0.84	2.25	0.69	1.75	0.53	1.75	0.53	0.53
22 AWG / 0.34 mm <sup>2</sup>	22	6.71	14	4.27	9	2.74	5.75	1.75	4.5	1.37	3.5	1.07	2.75	0.84	2.75	0.84	0.84
20 AWG / 0.5 mm <sup>2</sup>	35	10.67	23	7.01	14	4.27	9	2.74	7	2.13	5.75	1.75	4.5	1.37	4.25	1.30	1.30
18 AWG / 0.75 mm <sup>2</sup>	56	17.07	37	11.28	23	7.01	15	4.57	11	3.35	9	2.74	7.5	2.29	7	2.13	2.13
16 AWG / 1.5 mm <sup>2</sup>	90	27.44	60	18.29	37	11.28	24	7.32	18	5.49	15	4.57	12	3.66	11	3.35	3.35
14 AWG / 2.5 mm <sup>2</sup>	142	43.29	95	28.96	59	17.99	38	11.59	28	8.54	23	7.01	19	5.79	17	5.18	5.18
12 AWG / 4 mm <sup>2</sup>	226	68.90	151	46.04	94	28.66	60	18.29	45	13.72	37	11.28	30	9.15	28	8.54	8.54
10 AWG / 6 mm <sup>2</sup>	360	109.76	240	73.17	150	45.73	96	29.27	72	21.95	60	18.29	48	14.63	45	13.72	13.72
8 AWG / 10 mm <sup>2</sup>	574	175.00	381	116.16	239	72.87	153	46.65	115	35.06	95	28.96	76	23.17	71	21.65	21.65

WIRING DIAGRAMS

0-10V

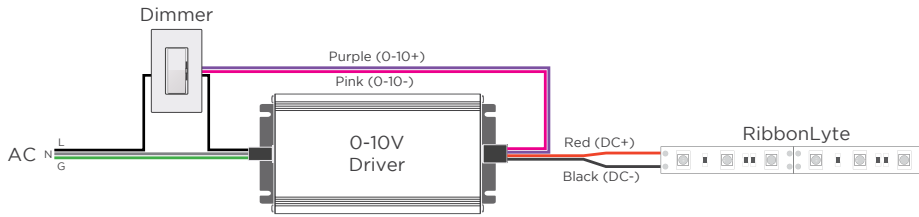

MLV / ELV

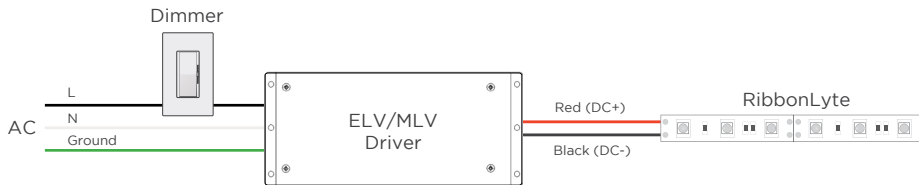

DMX

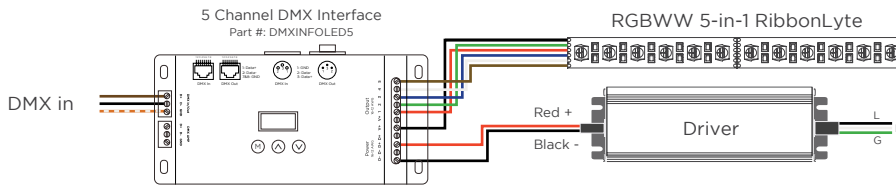

WARM DIM

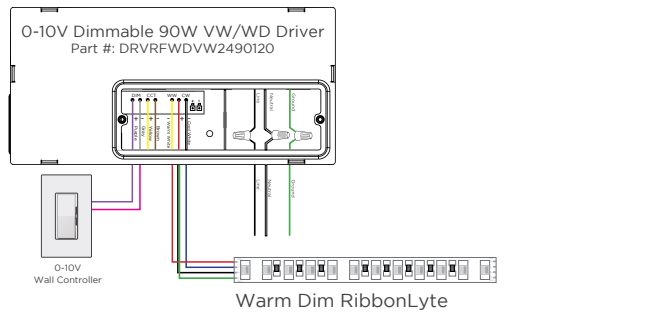

2-CHANNEL VARIABLE WHITE DIMMING

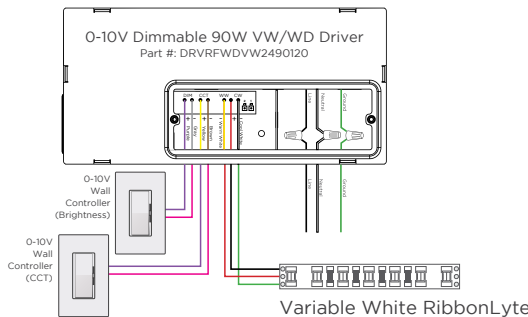

DMX WIRING DIAGRAM - COMPATIBLE WITH ALL MODELS OF VARIABLE WHITE RIBBONLYTE

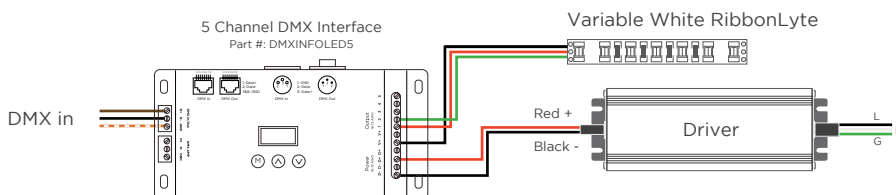

WIRE COLORS PER RIBBONLYTE COLOR

STATIC WHITE + STATIC COLOR

Red Wire (+) Positive  
Black Wire (-) Negative

RGBW + RGBA

Black Wire (+) Positive  
Green Wire (-) goes to Green Channel  
Red Wire (-) goes to Red Channel  
Blue Wire (-) goes to Blue Channel  
White Wire (-) goes to White Channel

RGBWW

Black (+) Positive  
Green Wire (-) goes to Green Channel  
Red Wire (-) goes to Red Channel  
Blue Wire (-) goes to Blue Channel  
White Wire (-) goes to White Channel 1  
Brown Wire (-) goes to White Channel 2

WARM DIM

Red Wire (-) goes to Warm White Channel  
Blue Wire (-) goes to Cool White Channel  
Black Wire (+) goes to Warm White Channel  
Green Wire (+) goes to Cool White Channel

VARIABLE WHITE

Black Wire (+) Positive  
Red Wire (-) goes to Warm White Channel  
Green Wire (-) goes to Cool White Channel