

AR3 CHANNEL FIXTURE

AR3 Channel Fixture is a recessed fixture with a 120-degree beam angle. We offer choices of clear, frosted and milky lenses to create a full range of light output and design options. Custom design a fixture for nearly any application with our AR3 Channel Fixture and RibbonLyte products.

- Available for field assembly or factory assembly
- Beam angle 120°
- Wattage Range from 0.75 W/ft (2.46 W/m) to 8.8 W/ft (28.9 W/m)
- Static White delivered lumen range from 44.1 lm/ft (144.6 lm/m) up to 729.4 lm/ft (2392.5 lm/m)
- Assembled in USA

HOUSING FINISHES



*Additional fee applies

AVAILABLE LENS FINISHES



AVAILABLE COLORS & COLOR TEMPERATURES

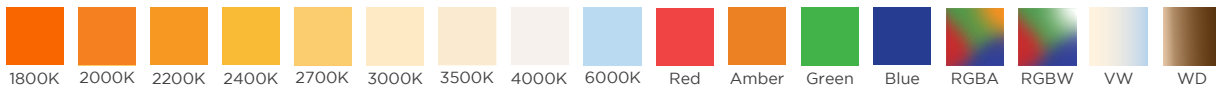

DIMENSIONS

AR3 Channel

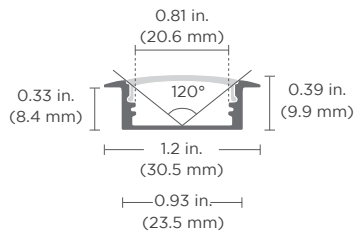

Width: 1.2 in. (30.5 mm)
Height: 0.39 in. (9.9 mm)
Internal Width: 0.81 in. (20.6 mm)
Recessed Width: 0.93 in. (23.5 mm)

Note: This channel does not require mounting clips. Please see our installation guide for instructions.

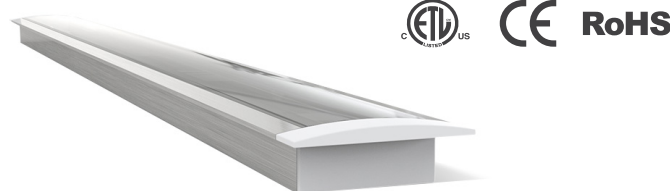

SPECIFICATIONS

Beam Angle	120°
Lens Type	Clear Lens, Frosted Lens, Milky Lens
Length	Channel is sold by the foot and cut to your exact desired length
Operating Voltage	24V
Dimming	MLV / 0-10 Volt / Lutron Hi-Lume 1% dimming LED drivers / Lutron VIVE code compliance available / ELV / DALI / DMX
Operating Temperature	-40° F to 158° F (-40° C to 70° C)
Colors	1800K, 2000K, 2200K, 2400K, 2700K, 3000K, 3500K, 4000K, 6000K, Red, Amber, Green, Blue, RGBW, RGBA, VW, Warm Dim RGBW Addressable (1800K, 2000K, 2200K only available in IP20)
CRI	90+ CRI (Static white only)
Lamp Life	L70 at 50,000 Hours
MacAdam Ellipses (SDCM)	2-Step Binning (For Static White LEDs only)
Certifications	ETL Listed: UL 2108 Issued: 2004/02/27 Ed: 1 Rev: 2014/02/24 Low Voltage Lighting Systems CSA C22.2#9.0 Issued: 1996/06/01 Ed: 1 (R2011) General Requirements for Luminaires; with Gen. Inst. 1: 1997, Gen Inst. 2: 1998. ROHS compliant UL 2108 - Low Voltage Lighting Systems UL 8750 - Light Emitting Diode (LED) Equipment for Use in Lighting Products UL 1598 / CSA 250.0-08 - Luminaires

ORDERING GUIDE

STEP 1 Complete Channel Part Number

CHANNEL	LENS		HOUSING COLOR	
CHAR3				
CHAR3 - AR3 Channel	C - Clear Lens*	M - Milky Lens	SV - Silver (default)	WH - White
	F - Frosted Lens	* Clear lens is the default option if not specified.	BK - Black	Consult factory for custom colors

STEP 2 Complete RibbonLyte Part Number

CATEGORY	CRI	RIBBON TYPE & IP RATING		
RB				
RB - RibbonLyte	0 - Static Color, Color Changing	SWS220 - Static White Series 2 IP20	RGBWS220 - RGBW Series 2 IP20	VWS220 - VW Series 2 IP20
	90 - 90+ CRI Static White	SWS265 - Static White Series 2 IP65	RGBWS265 - RGBW Series 2 IP65	VWS265 - VW Series 2 IP65
		SWS268 - Static White Series 2 IP68	RGBWS268 - RGBW Series 2 IP68	VWS268 - VW Series 2 IP68
		SCS220 - Static Color Series 2 IP20	RGBWA20 - RGBW/A IP20	WD20 - Warm Dim IP20
		SCS265 - Static Color Series 2 IP65	RGBWA65 - RGBW/A IP65	WD65 - Warm Dim IP65
		SCS268 - Static Color Series 2 IP68	RGBWA68 - RGBW/A IP68	WD68 - Warm Dim IP68
		RGBWADD - Addressable RGBW IP67		

NOTE: To ensure waterproofing standards are met, IP65 and IP68 RibbonLyte can NOT be cut in the field.

WATTAGE	COLOR
0.75 - 0.75 W/ft (2.46 W/m - Static White, Static Color)	18 - 1800K
1.0 - 1.0 W/ft (3.3 W/m - Variable White)	20 - 2000K
1.5 - 1.5 W/ft (4.9 W/m - Static White, Static Color)	22 - 2200K
2.2 - 2.2 W/ft (7.2 W/m - Static White, Static Color)	24 - 2400K
3.0 - 3.0 W/ft (9.8 W/m - Static White, Static Color, Variable White)	27 - 2700K
4.4 - 4.4 W/ft (14.4 W/m - Static White, Static Color, RGBW, RGBA)	30 - 3000K
5.2 - 5.2 W/ft (17.1 W/m - Warm Dim)	35 - 3500K
5.0 - 5.0 W/ft (16.4 W/m - Static White, Static Color)	40 - 4000K
5.5 - 5.5 W/ft (18.0 W/m - RGBW, RGBA)	60 - 6000K
6.0 - 6.0 W/ft (19.7 W/m - Static White, Static Color, Variable White, RGBW Addressable)	R - Red
8.8 - 8.8 W/ft (28.86 W/m - RGBW)	A - Amber
	G - Green
	B - Blue
	VW - Variable White
	RGB27 - Red, Green, Blue + 2700K
	RGB30 - Red, Green, Blue + 3000K
	RGB40 - Red, Green, Blue + 4000K
	RGB60 - Red, Green, Blue + 6000K
	RGBA - Red, Green, Blue + Amber
	RGBW30 - RGB + 3000K Addressable
	RGBW40 - RGB + 4000K Addressable
	RGBW60 - RGB + 6000K Addressable
	2920 - Warm Dim 2900K - 2000K (IP20)
	2721 - Warm Dim 2700K - 2100K (IP65+IP68)
	Z - Undecided**
	** For quotes only. Must be chosen before final order.

CONNECTION OPTIONS (See diagrams on the right)

- 1 - End Feed Bare Wire Connection
- 2 - Back Feed Bare Wire Connection
- 3 - Side Feed Bare Wire Connection
- 4 - End Feed with IP67 Male Coupler
- 5 - Soldered Daisy Chain
- 6 - Daisy Chain With IP67 Couplers

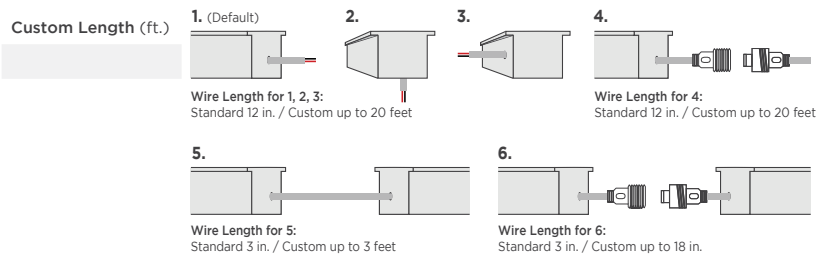

STEP 3 Complete Assembly Option & Length

ASSEMBLY OPTION	LENGTH (Standard factory assembled length up to 78 in. / 2 m)
FI - Field Assembly	
FA - Factory Assembly	

RIBBONLYTE SPECIFICATIONS & COMPATIBILITY

Available Wattages	Cuttable Length	LED Pitch	Color Temp.	lm/W without Lens	Delivered Lumens with Clear Lens	Delivered Lumens with Frosted Lens	Delivered Lumens with Milky Lens	Max Length	Compatible with Channel		
									IP20	IP65	IP68
0.75 Static White Series 2	1.97 in. (50 mm)	48 LEDs/ft (160 LEDs/m)	1800K	84	58 lm/ft (190.3 lm/m)	53.6 lm/ft (175.8 lm/m)	44.1 lm/ft (144.6 lm/m)	IP20: 49 ft (15 m) IP65/ IP68: 32.8 ft (10 m)	✓	✓	✓
			2000K	99	68.3 lm/ft (224 lm/m)	63.1 lm/ft (207 lm/m)	52 lm/ft (170.6 lm/m)				
			2200K	109	75.2 lm/ft (246.7 lm/m)	69.5 lm/ft (228 lm/m)	57.2 lm/ft (187.6 lm/m)				
			2400K	113	78 lm/ft (255.8 lm/m)	72.0 lm/ft (236.2 lm/m)	59.3 lm/ft (194.5 lm/m)				
			2700K	123	84.9 lm/ft (278.5 lm/m)	78.4 lm/ft (257.2 lm/m)	64.6 lm/ft (211.9 lm/m)				
			3000K	123	84.9 lm/ft (278.5 lm/m)	78.4 lm/ft (257.2 lm/m)	64.6 lm/ft (211.9 lm/m)				
			3500K	130	89.7 lm/ft (294.2 lm/m)	82.9 lm/ft (272 lm/m)	68.3 lm/ft (224 lm/m)				
			4000K	134	92.5 lm/ft (303.4 lm/m)	85.4 lm/ft (280.1 lm/m)	70.4 lm/ft (230.9 lm/m)				
6000K	131	90.4 lm/ft (296.5 lm/m)	83.5 lm/ft (273.9 lm/m)	68.8 lm/ft (225.7 lm/m)							
1.5 Static White Series 2	1.97 in. (50 mm)	48 LEDs/ft (160 LEDs/m)	1800K	84	115.9 lm/ft (380.2 lm/m)	107.1 lm/ft (351.3 lm/m)	88.2 lm/ft (289.3 lm/m)	IP20: 49 ft (15 m) IP65/ IP68: 32.8 ft (10 m)	✓	✓	✓
			2000K	98	135.2 lm/ft (443.5 lm/m)	125 lm/ft (410 lm/m)	102.9 lm/ft (337.5 lm/m)				
			2200K	109	150.4 lm/ft (493.3 lm/m)	139 lm/ft (455.9 lm/m)	114.5 lm/ft (375.6 lm/m)				
			2400K	113	155.9 lm/ft (511.4 lm/m)	144.1 lm/ft (472.6 lm/m)	118.7 lm/ft (389.3 lm/m)				
			2700K	123	169.7 lm/ft (556.6 lm/m)	156.8 lm/ft (514.3 lm/m)	129.2 lm/ft (423.8 lm/m)				
			3000K	123	169.7 lm/ft (556.6 lm/m)	156.8 lm/ft (514.3 lm/m)	129.2 lm/ft (423.8 lm/m)				
			3500K	129	178 lm/ft (583.8 lm/m)	164.5 lm/ft (539.6 lm/m)	135.5 lm/ft (444.4 lm/m)				
			4000K	134	184.9 lm/ft (606.5 lm/m)	170.9 lm/ft (560.6 lm/m)	140.7 lm/ft (461.5 lm/m)				
6000K	131	180.8 lm/ft (593 lm/m)	167 lm/ft (547.8 lm/m)	137.6 lm/ft (451.3 lm/m)							
2.2 Static White Series 2	1.97 in. (50 mm)	48 LEDs/ft (160 LEDs/m)	1800K	83	168 lm/ft (551 lm/m)	155.2 lm/ft (509.1 lm/m)	127.8 lm/ft (419.2 lm/m)	IP20: 42 ft (12.8 m) IP65/ IP68: 32.8 ft (10 m)	✓	✓	✓
			2000K	96	194.3 lm/ft (637.3 lm/m)	179.5 lm/ft (588.8 lm/m)	147.8 lm/ft (484.8 lm/m)				
			2200K	106	214.5 lm/ft (703.6 lm/m)	198.2 lm/ft (650.1 lm/m)	163.2 lm/ft (535.3 lm/m)				
			2400K	111	224.7 lm/ft (737 lm/m)	207.6 lm/ft (680.9 lm/m)	170.9 lm/ft (560.6 lm/m)				
			2700K	120	242.9 lm/ft (796.7 lm/m)	224.4 lm/ft (736 lm/m)	184.8 lm/ft (606.1 lm/m)				
			3000K	122	246.9 lm/ft (809.8 lm/m)	228.1 lm/ft (748.2 lm/m)	187.9 lm/ft (616.3 lm/m)				
			3500K	127	257 lm/ft (843 lm/m)	237.5 lm/ft (779 lm/m)	195.6 lm/ft (641.6 lm/m)				
			4000K	133	269.2 lm/ft (883 lm/m)	248.7 lm/ft (779 lm/m)	204.8 lm/ft (671.7 lm/m)				
6000K	128	259.1 lm/ft (849.8 lm/m)	239.4 lm/ft (785.2 lm/m)	197.1 lm/ft (646.5 lm/m)							
3.0 Static White Series 2	1.97 in. (50 mm)	48 LEDs/ft (160 LEDs/m)	2400K	109.8	303.1 lm/ft (994.1 lm/m)	280.1 lm/ft (918.6 lm/m)	230.6 lm/ft (756.5 lm/m)	IP20: 36 ft (11 m) IP65/ IP68: 32.8 ft (10 m)	✓	✓	✓
			2700K	122.9	339.6 lm/ft (1114 lm/m)	313.5 lm/ft (1028.1 lm/m)	258.1 lm/ft (846.7 lm/m)				
			3000K	130	359.1 lm/ft (1177.9 lm/m)	331.4 lm/ft (1087.1 lm/m)	273 lm/ft (895.3 lm/m)				
			3500K	133	367.5 lm/ft (1205.3 lm/m)	339.2 lm/ft (1112.4 lm/m)	279.3 lm/ft (916.1 lm/m)				
			4000K	133	367.5 lm/ft (1205.3 lm/m)	339.2 lm/ft (1112.4 lm/m)	279.3 lm/ft (916.1 lm/m)				
6000K	127	350.8 lm/ft (1150.5 lm/m)	323.7 lm/ft (1061.8 lm/m)	266.6 lm/ft (874.5 lm/m)							
4.4 Static White Series 2	1.97 in. (50 mm)	48 LEDs/ft (160 LEDs/m)	2400K	109	441.2 lm/ft (1447 lm/m)	407.7 lm/ft (1337.1 lm/m)	335.7 lm/ft (1101.2 lm/m)	28 ft 4 in. (8.64 m)	✓	✓	✓
			2700K	122	494.4 lm/ft (1621.6 lm/m)	456.3 lm/ft (1496.6 lm/m)	375.8 lm/ft (1232.5 lm/m)				
			3000K	129	522.8 lm/ft (1714.7 lm/m)	482.5 lm/ft (1582.5 lm/m)	397.3 lm/ft (1303.2 lm/m)				
			3500K	132	534.9 lm/ft (1754.5 lm/m)	493.7 lm/ft (1619.3 lm/m)	406.6 lm/ft (1333.5 lm/m)				
			4000K	132	534.9 lm/ft (1754.5 lm/m)	493.7 lm/ft (1619.3 lm/m)	406.6 lm/ft (1333.5 lm/m)				
6000K	126	510.6 lm/ft (1674.8 lm/m)	471.2 lm/ft (1545.7 lm/m)	388.1 lm/ft (1272.9 lm/m)							
5.0 Static White Series 2	1.4 in. (35.7 mm)	68 LEDs/ft (224 LEDs/m)	2400K	109.8	505.1 lm/ft (1656.8 lm/m)	466.8 lm/ft (1531 lm/m)	384.4 lm/ft (1260.8 lm/m)	IP20: 33 ft 4 in. (10.1 m) IP65/ IP68: 32.8 ft (10 m)	✓	✓	✓
			2700K	122.9	566.1 lm/ft (1856.7 lm/m)	522.4 lm/ft (1713.6 lm/m)	430.2 lm/ft (1411.2 lm/m)				
			3000K	130	598.5 lm/ft (1963.2 lm/m)	552.4 lm/ft (1811.9 lm/m)	454.9 lm/ft (1492.1 lm/m)				
			3500K	133	612.5 lm/ft (2008.9 lm/m)	565.3 lm/ft (1854 lm/m)	465.5 lm/ft (1526.8 lm/m)				
			4000K	133	612.5 lm/ft (2008.9 lm/m)	565.3 lm/ft (1854 lm/m)	465.5 lm/ft (1526.8 lm/m)				
6000K	127	584.6 lm/ft (1917.6 lm/m)	539.6 lm/ft (1769.7 lm/m)	444.3 lm/ft (1457.4 lm/m)							

RIBBONLYTE SPECIFICATIONS & COMPATIBILITY

Available Wattages	Cuttable Length	LED Pitch	Color Temp.	lm/W without Lens	Delivered Lumens with Clear Lens	Delivered Lumens with Frosted Lens	Delivered Lumens with Milky Lens	Max Length	Compatible with Channel		
									IP20	IP65	IP68
6.0 Static White Series 2	1.4 in. (35.7 mm)	68 LEDs/ft (224 LEDs/m)	2400K	109	601.6 lm/ft (1973.2 lm/m)	555.9 lm/ft (1823.4 lm/m)	457.8 lm/ft (1501.6 lm/m)	28 ft (8.5 m)	✓	✓	✓
			2700K	122	674.2 lm/ft (2211.3 lm/m)	622.2 lm/ft (2040.8 lm/m)	512.4 lm/ft (1680.7 lm/m)				
			3000K	129	712.9 lm/ft (2338.2 lm/m)	657.9 lm/ft (2157.9 lm/m)	541.8 lm/ft (1777.1 lm/m)				
			3500K	132	729.4 lm/ft (2392.5 lm/m)	673.2 lm/ft (2208.1 lm/m)	554.4 lm/ft (1818.4 lm/m)				
			4000K	132	612.5 lm/ft (2008.9 lm/m)	673.2 lm/ft (2208.1 lm/m)	554.4 lm/ft (1818.4 lm/m)				
			6000K	126	696.3 lm/ft (2283.8 lm/m)	642.6 lm/ft (2107.7 lm/m)	529.2 lm/ft (1735.8 lm/m)				
0.75 Static Color Series 2	1.97 in. (50 mm)	48 LEDs/ft (160 LEDs/m)	Red	41	28 lm/ft (93 lm/m)	26 lm/ft (86 lm/m)	22 lm/ft (70.6 lm/m)	IP20: 49 ft (15 m) IP65/ IP68: 32.8 ft (10 m)	✓	✓	✓
			Green	175	121 lm/ft (396 lm/m)	112 lm/ft (366 lm/m)	92 lm/ft (301.4 lm/m)				
			Blue	19	13 lm/ft (43 lm/m)	12 lm/ft (40 lm/m)	10 lm/ft (32.7 lm/m)				
			Amber	34	23 lm/ft (77 lm/m)	22 lm/ft (71 lm/m)	18 lm/ft (58.6 lm/m)				
1.5 Static Color Series 2	1.97 in. (50 mm)	48 LEDs/ft (160 LEDs/m)	Red	42	58 lm/ft (190 lm/m)	54 lm/ft (176 lm/m)	44 lm/ft (144.7 lm/m)	IP20: 49 ft (15 m) IP65/ IP68: 32.8 ft (10 m)	✓	✓	✓
			Green	160	221 lm/ft (724 lm/m)	204 lm/ft (669 lm/m)	168 lm/ft (551.1 lm/m)				
			Blue	18	25 lm/ft (81 lm/m)	23 lm/ft (75 lm/m)	19 lm/ft (62 lm/m)				
			Amber	34	47 lm/ft (154 lm/m)	43 lm/ft (142 lm/m)	36 lm/ft (117.1 lm/m)				
2.2 Static Color Series 2	1.97 in. (50 mm)	48 LEDs/ft (160 LEDs/m)	Red	42	85 lm/ft (279 lm/m)	79 lm/ft (258 lm/m)	65 lm/ft (212.2 lm/m)	IP20: 42 ft (12.8 m) IP65/ IP68: 32.8 ft (10 m)	✓	✓	✓
			Green	145	293 lm/ft (963 lm/m)	271 lm/ft (889 lm/m)	223 lm/ft (732.4 lm/m)				
			Blue	18	36 lm/ft (119 lm/m)	34 lm/ft (110 lm/m)	28 lm/ft (90.9 lm/m)				
			Amber	33	67 lm/ft (219 lm/m)	62 lm/ft (202 lm/m)	51 lm/ft (166.7 lm/m)				
3.0 Static Color Series 2	1.97 in. (50 mm)	48 LEDs/ft (160 LEDs/m)	Red	40.0	110.4 lm/ft (362.1 lm/m)	102.0 lm/ft (334.6 lm/m)	84.0 lm/ft (275.52 lm/m)	32.8 ft (10 m)	✓	✓	✓
			Green	127.0	350.9 lm/ft (1151.0 lm/m)	323.9 lm/ft (1062.2 lm/m)	266.7 lm/ft (874.776 lm/m)				
			Blue	25.0	69.1 lm/ft (226.6 lm/m)	63.8 lm/ft (209.1 lm/m)	52.5 lm/ft (172.2 lm/m)				
			Amber	29.0	80.1 lm/ft (262.8 lm/m)	74.0 lm/ft (242.6 lm/m)	60.9 lm/ft (199.752 lm/m)				
4.4 Static Color Series 2	1.97 in. (50 mm)	48 LEDs/ft (160 LEDs/m)	Red	38.0	153.8 lm/ft (504.5 lm/m)	142.1 lm/ft (466.2 lm/m)	117.0 lm/ft (383.8912 lm/m)	29 ft (8.8 m)	✓	✓	✓
			Green	117.0	474.1 lm/ft (1555.1 lm/m)	437.6 lm/ft (1435.3 lm/m)	360.4 lm/ft (1181.981 lm/m)				
			Blue	24.0	97.3 lm/ft (319.0 lm/m)	89.8 lm/ft (294.4 lm/m)	73.9 lm/ft (242.4576 lm/m)				
			Amber	25.0	101.3 lm/ft (332.2 lm/m)	93.5 lm/ft (306.7 lm/m)	77.0 lm/ft (252.56 lm/m)				
5.0 Static Color Series 2	1.4 in. (35.7 mm)	68 LEDs/ft (224 LEDs/m)	Red	37.0	170.2 lm/ft (558.2 lm/m)	157.3 lm/ft (515.8 lm/m)	129.5 lm/ft (424.76 lm/m)	30 ft (9.14 m)	✓	✓	✓
			Green	116.0	534.2 lm/ft (1752.1 lm/m)	493.0 lm/ft (1617.0 lm/m)	406.0 lm/ft (1331.68 lm/m)				
			Blue	24.0	110.5 lm/ft (362.5 lm/m)	102.0 lm/ft (334.6 lm/m)	84.0 lm/ft (275.52 lm/m)				
			Amber	26.0	119.7 lm/ft (392.7 lm/m)	110.5 lm/ft (362.4 lm/m)	91.0 lm/ft (298.48 lm/m)				
6.0 Static Color Series 2	1.4 in. (35.7 mm)	68 LEDs/ft (224 LEDs/m)	Red	37.0	204.2 lm/ft (669.8 lm/m)	188.7 lm/ft (618.9 lm/m)	155.4 lm/ft (509.712 lm/m)	28 ft (8.5 m)	✓	✓	✓
			Green	113.0	624.4 lm/ft (2048.2 lm/m)	576.3 lm/ft (1890.3 lm/m)	474.6 lm/ft (1556.688 lm/m)				
			Blue	23.0	127.1 lm/ft (416.9 lm/m)	117.3 lm/ft (384.8 lm/m)	96.6 lm/ft (316.9 lm/m)				
			Amber	24.0	132.6 lm/ft (435.0 lm/m)	122.4 lm/ft (401.6 lm/m)	100.8 lm/ft (330.7 lm/m)				
1.0 Variable White Series 2	1.97 in. (50 mm)	42 LEDs/ft (140 LEDs/m)	2000K + 6500K	85.0	78.2 lm/ft (257 lm/m)	72.3 lm/ft (237 lm/m)	60 lm/ft (200 lm/m)	32.8 ft (10 m)	✓	✓	✓
3.0 Variable White Series 2	1.97 in. (50 mm)	42 LEDs/ft (140 LEDs/m)	2000K + 6500K	80.0	220.8 lm/ft (725 lm/m)	205.0 lm/ft (670 lm/m)	168.0 lm/ft (551.2 lm/m)	32.8 ft (10 m)	✓	✓	✓
6.0 Variable White Series 2	1.97 in. (50 mm)	42 LEDs/ft (140 LEDs/m)	2000K + 6500K	75.0	415 lm/ft (1,362 lm/m)	382.5 lm/ft (1255 lm/m)	315.0 lm/ft (1033.5 lm/m)	32.8 ft (10 m)	✓	✓	✓

RIBBONLYTE SPECIFICATIONS & COMPATIBILITY

Available Wattages	Cuttable Length	LED Pitch	Color Temp.	lm/W without Lens	Delivered Lumens with Clear Lens	Delivered Lumens with Frosted Lens	Delivered Lumens with Milky Lens	Max Length	Compatible with Channel		
									IP20	IP65	IP68
4.4 RGBW Series 2	1.97 in. (50 mm)	36 LEDs/ft (120 LEDs/m)	RGBW	45	188.1 lm/ft (617.2 lm/m) All LEDs at 100%	168.3 lm/ft (552.2 lm/m) All LEDs at 100%	148.5 lm/ft (487.2 lm/m) All LEDs at 100%	19 ft 8 in. (6 m)	✓	N/A	N/A
5.5 RGBW Series 2	1.97 in. (50 mm)	36 LEDs/ft (120 LEDs/m)	RGBW	59	308.8 lm/ft (1013.0 lm/m) All LEDs at 100%	275.8 lm/ft (904.9 lm/m) All LEDs at 100%	243.3 lm/ft (798.5 lm/m) All LEDs at 100%	19 ft 7.9 in. (6 m)	N/A	✓	✓
8.8 RGBW Series 2	1.97 in. (50 mm)	36 LEDs/ft (120 LEDs/m)	RGBW	61	510.2 lm/ft (1673.8 lm/m) All LEDs at 100%	456.3 lm/ft (1497.1 lm/m) All LEDs at 100%	402.6 lm/ft (1320.9 lm/m) All LEDs at 100%	16 ft 4 in. (5 m)	✓	N/A	N/A
4.4 RGBW	6.55 in. (166.4 mm)	18 LEDs/ft (60 LEDs/m)	RGBW	65	263.1 lm/ft (863 lm/m)	243.95 lm/ft (799.85 lm/m) All LEDs at 100%	200.9 lm/ft (658.7 lm/m) All LEDs at 100%	19 ft 7.9 in. (6 m)	✓	✓	✓
4.4 RGBA	6.55 in. (166.4 mm)	18 LEDs/ft (60 LEDs/m)	RGBA	33	133.6 lm/ft (438.1 lm/m)	243.95 lm/ft (799.85 lm/m) All LEDs at 100%	200.9 lm/ft (658.7 lm/m) All LEDs at 100%	19 ft 7.9 in. (6 m)	✓	✓	✓
5.5 4-in-1 RGBW	3.94 in. (100 mm)	18 LEDs/ft (60 LEDs/m)	RGBW	51	305 lm/ft (1000.3 lm/m)	237.15 lm/ft (777.75 lm/m) All LEDs at 100%	195.3 lm/ft (640.5 lm/m) All LEDs at 100%	19 ft 7.9 in. (6 m)	✓	✓	✓
5.5 4-in-1 RGBA	3.94 in. (100 mm)	18 LEDs/ft (60 LEDs/m)	RGBA	27	161.5 lm/ft (529.6 lm/m)	237.15 lm/ft (777.75 lm/m) All LEDs at 100%	195.3 lm/ft (640.5 lm/m) All LEDs at 100%	19 ft 7.9 in. (6 m)	✓	✓	✓
RGBW Addressable	3.94 in. (100 mm)	18 LEDs/ft (60 LEDs/m)	Red	33.5	30.8 lm/ft (101.2 lm/m)	28.5 lm/ft (93.5 lm/m)	23.5 lm/ft (77 lm/m)	16 ft 5.64 in. (5.02 m)	N/A	N/A	✓ IP67
			Green	82	75.4 lm/ft (247.5 lm/m)	69.7 lm/ft (228.7 lm/m)	57.4 lm/ft (188.3 lm/m)				
			Blue	15.5	14.2 lm/ft (46.7 lm/m)	13.2 lm/ft (43.2 lm/m)	10.8 lm/ft (35.6 lm/m)				
			White	103	94.8 lm/ft (310.9 lm/m)	87.6 lm/ft (287.3 lm/m)	72.1 lm/ft (236.6 lm/m)				
			All	40	222.8 lm/ft (730.8 lm/m)	205.8 lm/ft (675.2 lm/m)	169.5 lm/ft (556.1 lm/m)				
5.2 Warm Dim	3.94 in. (100 mm)	36 LEDs/ft (120 LEDs/m)	WARM DIM	55	263.1 lm/ft (863 lm/m)	244.8 lm/ft (803.25 lm/m)	201.6 lm/ft (661.5 lm/m)	16 ft 4 in. (5 m)	✓	✓	✓

DIODE VISIBILITY CHART (Data below applies to installations with Milky lens only)

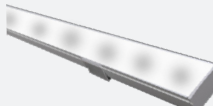
 No Visible Diode = N				 With Visible Diode = Y						
Static White & Static Color RibbonLyte				Color Changing RibbonLyte						
0.75/1.5/2.2	3.0/4.4		5.0/6.0	4.4 RGBW Series 2	5.5 RGBW Series 2	8.8 RGBW Series 2	4.4 RGBW/A	5.5 4-in-1 RGBW/A	Warm Dim	Variable White
IP20 IP65 IP68	IP20 IP65	IP68	IP20 IP65 IP68	IP20	IP65 IP68	IP20	IP20 IP65	IP20 IP65	IP20 IP65 IP68	IP20 IP65 IP68
Y	N	Y	N	Y	Y	Y	Y	Y	Y	Y

AVAILABLE DRIVERS

NON-DIMMING ELECTRONIC DRIVERS



**30W, 60W, 96W
Non-Dimming Electronic
Class 2 Drivers**

Part No.:

- DRVW2430 (30 Watt)
- DRVW2460 (60 Watt)
- DRVW2496 (96 Watt)

Output Voltage: 24 V
Voltage Range: 120-277 VAC
IP Rating: Dry or Damp
UL Listed



**240W, 320W
Non-Dimming
Electronic Drivers**

Part No.:

- DRVW24240 (240 Watt)
- DRVW24320 (320 Watt)

Output Voltage: 24 V
Voltage Range: 90-305 VAC
IP Rating: Dry or Damp
UL Recognized

LUTRON HI-LUME DRIVERS



**40W
Lutron Hi-Lume 1% Dimming
Class 2 Drivers**

Part No.:

- DRVLUT24403W (40 Watt, 3-wire)
- DRVLUT24402W (40 Watt, 2-wire)

Output Voltage: 24 V
Voltage Range: 120-277 VAC (3-wire model)
or 120V (2-wire model)
IP Rating: Dry or Damp
Dimmable using 2-wire forward phase,
3-wire+G or digital EcoSystem
UL Listed

ELV & MLV DRIVERS WITH COMPATIBLE DIMMERS



**60W, 96W, 150W, 300W
ELV/MLV Dimmable Drivers**

Part No.:

- DRVW2460ELVMLV (60 Watt)
- DRVW2496ELVMLV (96 Watt)
- DRVW24150ELVMLV (150 Watt)
- DRVW24300ELVMLV (300 Watt)

Line Voltage Dimmable Drivers
Output Voltage: 24 V
Voltage Range: 100-277 VAC
IP Rating: IP67
Dimmable
UL, CE, and CSA Listed



LUTRON Skylark Contour Dimmer

Part No.: TRIDIMSKY

Width: 2.94 in (75 mm)
Length: 4.69 in (120 mm)
Depth: 0.30 in (7.6 mm)

- Single pole and 3-way versions
- Compatible with Acolyte MLV drivers
- Slide adjusts brightness and On/Off control
- 30 mA max control current
- Available in white finish



LUTRON NOVA-T Dimmer

Part No.: TRIDIMNOVA

Width: 2.75 in (70 mm)
Length: 4.56 in (116 mm)
Depth: 0.30 in (7.6 mm)

- Slide adjusts brightness and On/Off control
- 30 mA max control current
- Available in white finish



LUTRON DIVA Dimmer

Part No.: TRIDIMDIVA

(With Locator Light) TRIDIMDIVAL
Width: 2.94 in (75 mm)
Length: 4.69 in (120 mm)
Depth: 0.30 in (7.6 mm)

- Large paddle switch with a captive linear-slide dimmer
- 30 mA max control current
- Available in white finish
- Available with locator light which glows green when the switch is off

Note: For more options, please reference the Optional Dimmer List on Acolyte product website page.

AVAILABLE DRIVERS / CONTROLLERS AND DIMMING OPTIONS / WIRE GAUGE CHART

0-10V DRIVERS AND DIMMERS

DIMMING MODULE



0-10V Dimmable Waterproof Drivers

96W Part No.: DRVW249610P
288W Part No.: DRVW2428810P
Output Voltage: 24 V (+/- 0.5V)
Voltage Range: 100-277 VAC
Environmental Rating: UL Wet Location
UL Listed



LUTRON DIVA Dimmer

Part No.: LVDIMDIVA
Width: 2.94 in (75 mm)
Length: 4.69 in (120 mm)
Depth: 0.30 in (7.6 mm)

- Compatible with 0-10 V Dimming Module
- Large paddle switch with a captive linear-slide dimmer
- 30 mA max control current
- Available in white finish



LUTRON NOVA-T Dimmer

Part No.: LVDIMNOVA
Width: 2.75 in (70 mm)
Length: 4.56 in (116 mm)
Depth: 0.30 in (7.6 mm)

- Compatible with 0-10 V Dimming Module
- Slide adjusts brightness and On/Off control
- 30 mA max control current
- Available in white finish



Variable White Dimming Module

Part No.: VWDIMMOD

- 1 dimming module required per 30 ft (9.1 m)
- This product is only compatible with Variable White RibbonLyte, not Variable White Amber or Variable White Red. Works with any 0-10V dimmers to provide CCT change with one dimmer and brightness change with the other.

Note: Max length before additional power is introduced

DMX CONTROLLER AND PART NUMBER - FOR COLOR CHANGING VERSIONS



GLASS TOUCH

WALL CONTROLLERS

Part Number: AWCRGBWW
AWCVWW



1 ZONE WALL CONTROLLER

Part Number: DMXCTRLG



5 ZONE WALL CONTROLLER

Part Number: DMXCTRL



10 ZONE WALL CONTROLLER

Part Number: DMXCTRLD

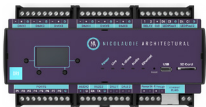

2 UNIVERSE DMX CONTROLLER

Part Number: DMXCTRLDR2U

6 UNIVERSE DMX CONTROLLER

Part Number: DMXCTRLDR6U



4 CHANNEL WATERPROOF DMX INTERFACE

Part Number: DMXINFWLCD4



5 CHANNEL DMX INTERFACE

Part Number: DMXINFLCD5



DMX OPTO SPLITTER

Part Number: DMXOS8

DRIVER AND RIBBONLYTE AT FULL LOAD

Wattages	30		60		96		150		200		240		300		320	
Wire Gauge	Feet	Meters	Feet	Meters	Feet	Meters	Feet	Meters	Feet	Meters	Feet	Meters	Feet	Meters	Feet	Meters
24 AWG	14	4.27	9	2.74	5.5	1.68	3.75	1.14	2.75	0.84	2.25	0.69	1.75	0.53	1.75	0.53
22 AWG	22	6.71	14	4.27	9	2.74	5.75	1.75	4.5	1.37	3.5	1.07	2.75	0.84	2.75	0.84
20 AWG	35	10.67	23	7.01	14	4.27	9	2.74	7	2.13	5.75	1.75	4.5	1.37	4.25	1.30
18 AWG	56	17.07	37	11.28	23	7.01	15	4.57	11	3.35	9	2.74	7.5	2.29	7	2.13
16 AWG	90	27.44	60	18.29	37	11.28	24	7.32	18	5.49	15	4.57	12	3.66	11	3.35
14 AWG	142	43.29	95	28.96	59	17.99	38	11.59	28	8.54	23	7.01	19	5.79	17	5.18
12 AWG	226	68.90	151	46.04	94	28.66	60	18.29	45	13.72	37	11.28	30	9.15	28	8.54
10 AWG	360	109.76	240	73.17	150	45.73	96	29.27	72	21.95	60	18.29	48	14.63	45	13.72
8 AWG	574	175.00	381	116.16	239	72.87	153	46.65	115	35.06	95	28.96	76	23.17	71	21.65

WIRING DIAGRAMS

0-10V

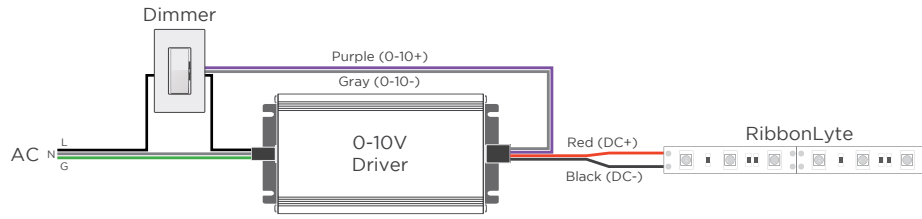

MLV / ELV

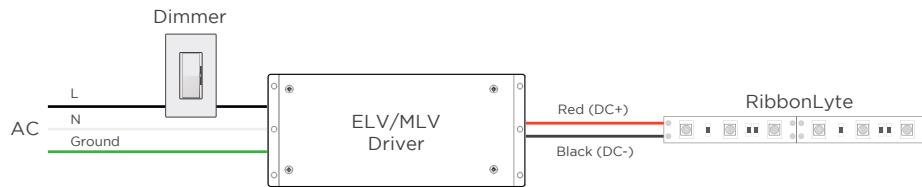

DMX

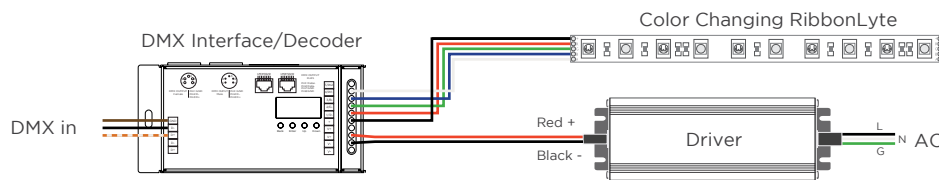

WARM DIM

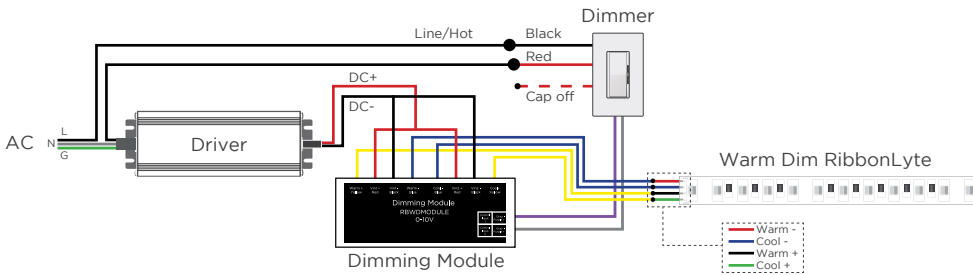

2-CHANNEL VARIABLE WHITE DIMMING

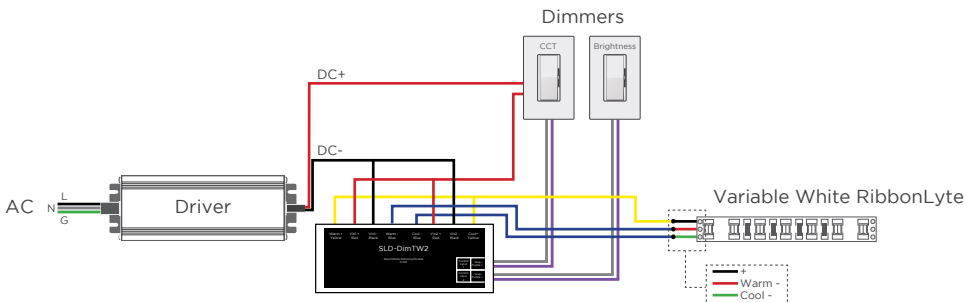

DMX WIRING DIAGRAM - COMPATIBLE WITH ALL MODELS OF VARIABLE WHITE RIBBONLYTE

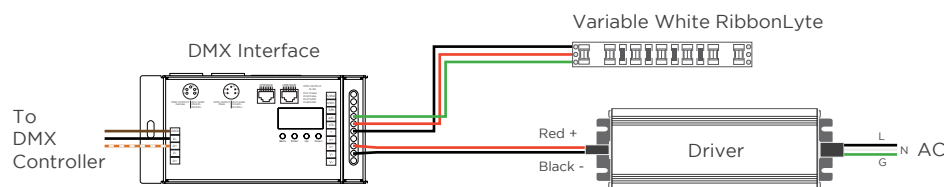

WIRE COLORS PER RIBBONLYTE COLOR

STATIC WHITE + STATIC COLOR

Red Wire (+) Positive
Black Wire (-) Negative

RGBW + RGBA

Black Wire (+) Positive
Red Wire (-) goes to Red Channel
Green Wire (-) goes to Green Channel
Blue Wire (-) goes to Blue Channel
White Wire (-) goes to White Channel

WARM DIM

Red Wire (-) goes to Warm White Channel
Blue Wire (-) goes to Cool White Channel
Black Wire (+) goes to Warm White Channel
Green Wire (+) goes to Cool White Channel

VARIABLE WHITE

Black Wire (+) Positive
Red Wire (-) goes to Warm White Channel
Green Wire (-) goes to Cool White Channel

WIRING DIAGRAMS WITH RGBW ADDRESSABLE RIBBONLYTE

1 DMX Universe consists of 128 addresses and 512 channels. (42 ft 8 in. of RibbonLyte)

If RibbonLyte is more than 16 feet 4 inches then DMX Opto Splitter will need to be introduced. Every individual run needs its own DMX Opto Splitter output.

WIRING OPTION 1

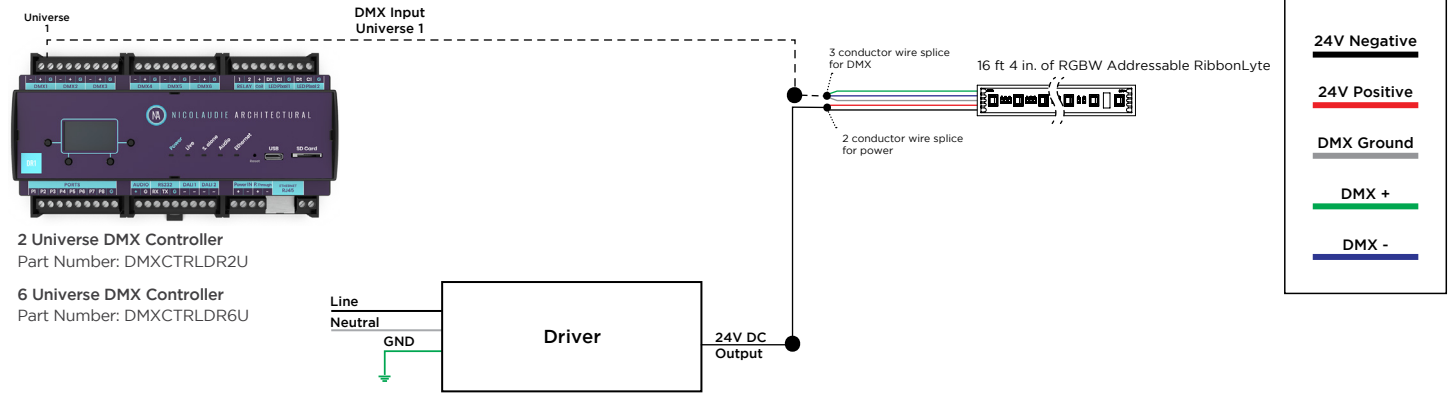

WIRING OPTION 2 (with DMX Opto Splitter)

