

### AR3 CHANNEL FIXTURE

AR3 Channel Fixture is a recessed fixture with a 110-degree beam angle. We offer choices of clear, frosted and milky lenses to create a full range of light output and design options. Custom design a fixture for nearly any application with our AR3 Channel Fixture and RibbonLyte products.

- Available for field assembly or factory assembly
- Beam angle 110°
- Wattage Range from 0.75 W/ft (2.46 W/m) to 8.8 W/ft (28.9 W/m)
- Static White delivered lumen range from 44.1 lm/ft (144.6 lm/m) up to 729.4 lm/ft (2392.5 lm/m)
- Assembled in USA

### HOUSING FINISHES



\*Additional fee applies

### AVAILABLE LENS FINISHES



### AVAILABLE COLORS & COLOR TEMPERATURES



### DIMENSIONS

#### AR3 Channel

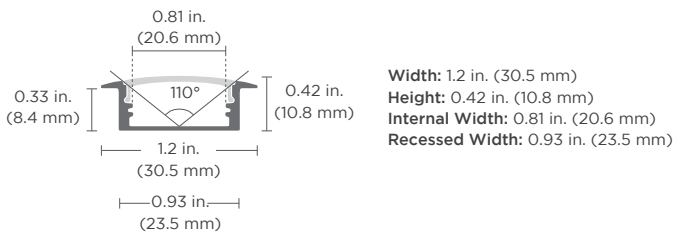

#### Mounting Clip

Material: stainless steel

#### Side View

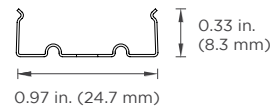

#### Top View

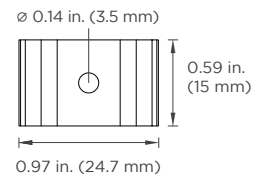

**Width:** 0.59 in. (15 mm)  
**Length:** 0.97 in. (24.7 mm)  
**Height:** 0.33 in. (8.3 mm)

#### NOTE:

1. This channel does not require mounting clips. Please see our installation guide for instructions.
2. Exterior channel applications should be securely attached to the mounting surface with appropriate screws and/or liquid nails.
3. Acolyte strongly recommends field assembly for exterior applications.

Acolyte does not warrant or represent that the information is free from errors or omission. The information may change without notice and Acolyte is not in any way liable for the accuracy of any information printed and stored or in any way interpreted or used.



RoHS

Declare.

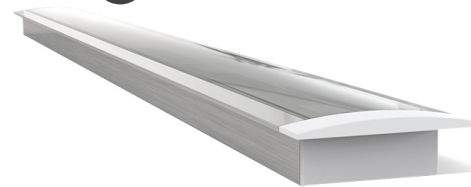

**SPECIFICATIONS**

<b>Beam Angle</b>	110°
<b>Lens Type</b>	Clear Lens, Frosted Lens, Milky Lens
<b>Length</b>	Channel is sold by the foot and cut to your exact desired length
<b>Operating Voltage</b>	24 V
<b>Dimming</b>	MLV / 0-10 Volt / ELV / DALI / DMX
<b>Operating Temperature</b>	-40 – 158 °F (-40 – 70 °C)
<b>Colors</b>	1800K, 2000K, 2200K, 2400K, 2700K, 3000K, 3500K, 4000K, 6000K, Red, Amber, Green, Blue, RGBW, RGBWW, RGBA, VW, Warm Dim RGBW Addressable (1800K, 2000K, 2200K only available in IP20)
<b>CRI</b>	90+ CRI (Static white only)
<b>Lifetime (L70 reported)</b>	50,000 hours
<b>MacAdam ellipse (SDCM)</b>	2-Step Binning (For Static White LEDs only)
<b>Certifications</b>	UL Listed UL 2108 Issued: 2004/02/27 Ed: 1 Rev: 2014/02/24 Low Voltage Lighting Systems CSA C22.2#9.0 Issued: 1996/06/01 Ed: 1 (R2011) General Requirements for Luminaries; with Gen. Inst. 1: 1997, Gen Inst. 2: 1998. ROHS compliant

**ACCESSORIES**

**End Caps**

Material: ABS

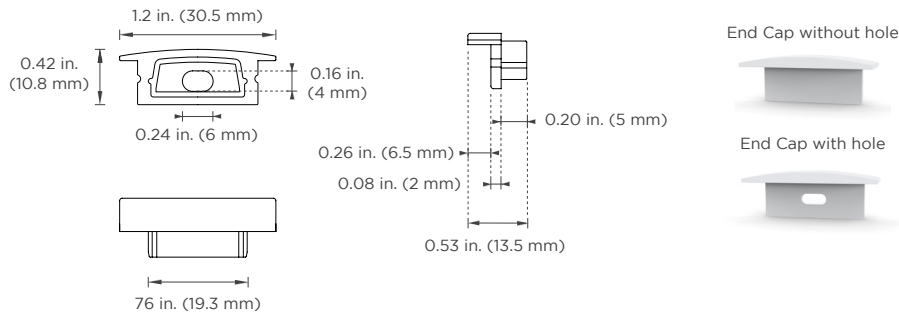

Acolyte does not warrant or represent that the information is free from errors or omission. The information may change without notice and Acolyte is not in any way liable for the accuracy of any information printed and stored or in any way interpreted or used.

ORDERING GUIDE

**STEP 1** Complete Channel Part Number

CHANNEL	LENS	HOUSING COLOR
<b>CHAR3</b>		
CHAR3 - AR3 Channel	C - Clear Lens*    M - Milky Lens F - Frosted Lens    * Clear lens is the default option if not specified.	SV - Silver (default)    WH - White** BK - Black**    ** Additional fee applies Consult factory for custom colors

**STEP 2** Complete RibbonLyte Part Number

CATEGORY	CRI	RIBBON TYPE & IP RATING
<b>RB</b>		
RB - RibbonLyte	0 - Static Color, Color Changing 90 - 90+ CRI Static White	<b>LINEA20</b> - Linea RibbonLyte IP20 <b>SWS220</b> - Static White Series 2 IP20 <b>SWS265</b> - Static White Series 2 IP65 <b>SWS268</b> - Static White Series 2 IP68 <b>SCS220</b> - Static Color Series 2 IP20 <b>SCS265</b> - Static Color Series 2 IP65 <b>SCS268</b> - Static Color Series 2 IP68 <b>RGBWW20</b> - RGBWW 5-in-1 IP20 <b>RGBWS220</b> - RGBW Series 2 IP20 <b>RGBWS265</b> - RGBW Series 2 IP65 <b>RGBWS268</b> - RGBW Series 2 IP68 <b>VWS220</b> - VW Series 2 IP20 <b>VWS265</b> - VW Series 2 IP65 <b>VWS268</b> - VW Series 2 IP68 <b>RGBWADD</b> - Addressable RGBW IP67 <b>WD20</b> - Warm Dim IP20 <b>WD65</b> - Warm Dim IP65 <b>WD68</b> - Warm Dim IP68

**NOTE:** To ensure waterproofing standards are met, IP65 and IP68 RibbonLyte can NOT be cut in the field.

WATTAGE	COLOR
0.75 - 0.75 W/ft (2.46 W/m - Static White, Static Color)	18 - 1800K    VW - Variable White
1.0 - 1.0 W/ft (3.3 W/m - Variable White)	20 - 2000K    RGB27 - Red, Green, Blue + 2700K
1.5 - 1.5 W/ft (4.9 W/m - Static White, Static Color)	22 - 2200K    RGB30 - Red, Green, Blue + 3000K
2.2 - 2.2 W/ft (7.2 W/m - Static White, Static Color)	24 - 2400K    RGB40 - Red, Green, Blue + 4000K
2.4 - 2.4 W/ft (8 W/m - Static White Linea)	27 - 2700K    RGB2465 - Red, Green, Blue + 2400K + 6500K
3.0 - 3.0 W/ft (9.8 W/m - Static White, Static Color, Variable White)	30 - 3000K    RGBA - Red, Green, Blue + Amber
4.3 - 4.3 W/ft (14 W/m - Static White Linea)	35 - 3500K    RGBW30 - RGB + 3000K Addressable
4.4 - 4.4 W/ft (14.4 W/m - Static White, Static Color, RGBW, RGBWW, RGBA)	40 - 4000K    RGBW40 - RGB + 4000K Addressable
5.2 - 5.2 W/ft (17.1 W/m - Warm Dim)	60 - 6000K    RGBW60 - RGB + 6000K Addressable
5.0 - 5.0 W/ft (16.4 W/m - Static White, Static Color)	R - Red    2920 - Warm Dim 2900K - 2000K (IP20)
5.5 - 5.5 W/ft (18.0 W/m - RGBW, RGBA)	A - Amber    2721 - Warm Dim 2700K - 2100K (IP65+IP68)
6.0 - 6.0 W/ft (19.7 W/m - Static White, Static Color, Variable White, RGBW Addressable)	G - Green    Z - Undecided**
6.1 - 6.1 W/ft (20 W/m - Variable White Linea)	B - Blue    ** For quotes only. Must be chosen before final order.
8.8 - 8.8 W/ft (28.86 W/m - RGBW, RGBWW)	

CONNECTION OPTIONS (See diagrams on the right)

- 1 - End Feed Bare Wire Connection
- 2 - Back Feed Bare Wire Connection
- 3 - Side Feed Bare Wire Connection
- 4 - End Feed with IP67 Male Coupler
- 5 - Soldered Daisy Chain
- 6 - Daisy Chain With IP67 Couplers

Custom Length (ft.)

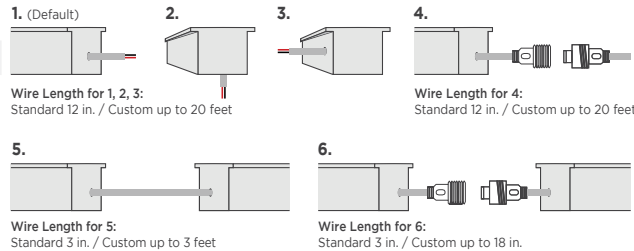

**STEP 3** Complete Assembly Option & Length

ASSEMBLY OPTION	LENGTH (Standard factory assembled length up to 6 ft 6.7 in. / 2 m)
FI - Field Assembly	
FA - Factory Assembly* (not recommended for exterior applications)	

\* Factory assembled runs exceeding 6 ft 6.7 in. (2 m) will be split into multiple daisy chained fixtures.

**DO NOT BUTT END CAPS AGAINST EACH OTHER WHEN CREATING LONGER FIXTURES**

Acolyte STRONGLY SUGGESTS field assembly (without using interior end caps) for direct-view fixtures of more than 6 ft 6.7 in. (2 m) in length. Field assembly without interior end caps will eliminate gaps or dead spots that can be caused by butting interior end caps against each other.

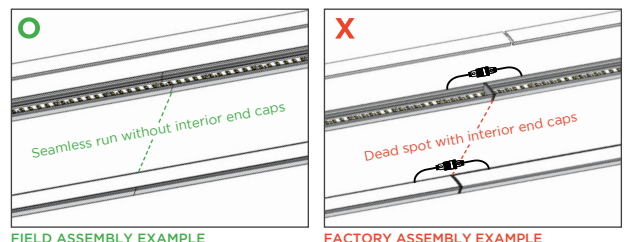

RIBBONLYTE SPECIFICATIONS & COMPATIBILITY

Available Wattages	Cutttable Length	LED Pitch	Color Temp.	lm/W without Lens	Delivered Lumens with Clear Lens		Delivered Lumens with Frosted Lens		Delivered Lumens with Milky Lens		Max Length	Compatible with Channel		
					lm/ft	lm/m	lm/ft	lm/m	lm/ft	lm/m		IP20	IP65	IP68
0.75 Static White Series 2	1.97 in. (50 mm)	48 LEDs/ft (160 LEDs/m)	1800K	84	58	190.3	53.6	175.8	44.1	144.6	IP20: 49 ft (15 m) IP65: 32.8 ft (10 m)	✓	✓	✓
			2000K	99	68.3	224	63.1	207	52	170.6				
			2200K	109	75.2	246.7	69.5	228	57.2	187.6				
			2400K	113	78	255.8	72	236.2	59.3	194.5				
			2700K	123	84.9	278.5	78.4	257.2	64.6	211.9				
			3000K	123	84.9	278.5	78.4	257.2	64.6	211.9				
			3500K	130	89.7	294.2	82.9	272	68.3	224				
			4000K	134	92.5	303.4	85.4	280.1	70.4	230.9				
6000K	131	90.4	296.5	83.5	273.9	68.8	225.7							
1.5 Static White Series 2	1.97 in. (50 mm)	48 LEDs/ft (160 LEDs/m)	1800K	84	115.9	380.2	107.1	351.3	88.2	289.3	IP20: 49 ft (15 m) IP65: 32.8 ft (10 m)	✓	✓	✓
			2000K	98	135.2	443.5	125	410	102.9	337.5				
			2200K	109	150.4	493.3	139	455.9	114.5	375.6				
			2400K	113	155.9	511.4	144.1	472.6	118.7	389.3				
			2700K	123	169.7	556.6	156.8	514.3	129.2	423.8				
			3000K	123	169.7	556.6	156.8	514.3	129.2	423.8				
			3500K	129	178	583.8	164.5	539.6	135.5	444.4				
			4000K	134	184.9	606.5	170.9	560.6	140.7	461.5				
6000K	131	180.8	593	167	547.8	137.6	451.3							
2.2 Static White Series 2	1.97 in. (50 mm)	48 LEDs/ft (160 LEDs/m)	1800K	83	168	51	155.2	509.1	127.8	419.2	IP20: 42 ft (12.8 m) IP65: 32.8 ft (10 m)	✓	✓	✓
			2000K	96	194.3	637.3	179.5	588.8	147.8	484.8				
			2200K	106	214.5	703.6	198.2	650.1	163.2	535.3				
			2400K	111	224.7	737	207.6	680.9	170.9	560.6				
			2700K	120	242.9	796.7	224.4	736	184.8	606.1				
			3000K	122	246.9	809.8	228.1	748.2	187.9	616.3				
			3500K	127	257	843	237.5	779	195.6	641.6				
			4000K	133	269.2	883	248.7	779	204.8	671.7				
6000K	128	259.1	849.8	239.4	785.2	197.1	646.5							
3.0 Static White Series 2	1.97 in. (50 mm)	48 LEDs/ft (160 LEDs/m)	1800K	84	231.8	760.4	214.2	702.6	176.4	578.6	IP20: 36 ft (11 m) IP65: 32.8 ft (10 m)	✓	✓	✓
			2000K	98	270.5	887.2	249.9	819.7	205.8	675				
			2200K	108	298.1	977.7	275.4	903.3	226.8	743.9				
			2400K	109.8	303.1	994.1	280.1	918.6	230.6	756.5				
			2700K	122.9	339.6	1114	313.5	1028.1	258.1	846.7				
			3000K	130	359.1	1177.9	331.4	1087.1	273	895.3				
			3500K	133	367.5	1205.3	339.2	1112.4	279.3	916.1				
			4000K	133	367.5	1205.3	339.2	1112.4	279.3	916.1				
6000K	127	350.8	1150.5	323.7	1061.8	266.6	874.5							
4.4 Static White Series 2	1.97 in. (50 mm)	48 LEDs/ft (160 LEDs/m)	1800K	81	327.9	1075.5	302.9	993.6	249.5	818.3	28 ft 4 in. (8.64 m)	✓	✓	✓
			2000K	95	384.6	1261.4	355.3	1165.4	292.6	959.7				
			2200K	105	425	1394.1	392.7	1288.1	323.4	1060.8				
			2400K	109	441.2	1447	407.7	1337.1	335.7	1101.2				
			2700K	124	494.4	1621.6	456.3	1496.6	375.8	1232.5				
			3000K	131	522.8	1714.7	482.5	1582.5	397.3	1303.2				
			3500K	133	534.9	1754.5	493.7	1619.3	406.6	1333.5				
			4000K	133	534.9	1754.5	493.7	1619.3	406.6	1333.5				
6000K	128	510.6	1674.8	471.2	1545.7	388.1	1272.9							
5.0 Static White Series 2	1.4 in. (35.7 mm)	68 LEDs/ft (224 LEDs/m)	1800K	83	381.8	1252.3	352.8	1157	290.5	952.8	IP20: 33 ft 4 in. (10.1 m) IP65: 32.8 ft (10 m)	✓	✓	
			2000K	98	450.8	1478.6	416.5	1366.1	343	1125				
			2200K	107	492.2	1614.4	454.8	1491.6	374.5	1228.4				
			2400K	110	505.1	1656.8	466.8	1531	384.4	1260.8				
			2700K	124	566.1	1856.7	522.4	1713.6	430.2	1411.2				
			3000K	134	598.5	1963.2	552.4	1811.9	454.9	1492.1				
			3500K	135	612.5	2008.9	565.3	1854	465.5	1526.8				
			4000K	134	612.5	2008.9	565.3	1854	465.5	1526.8				
6000K	130	584.6	1917.6	539.6	1769.7	444.3	1457.4							
6.0 Static White Series 2	1.4 in. (35.7 mm)	68 LEDs/ft (224 LEDs/m)	1800K	82	452.6	1484.7	418.2	1371.7	344.4	1129.6	28 ft (8.5 m)	✓	✓	
			2000K	95	524.4	1720	484.5	1589.2	399.0	1308.7				
			2200K	106	585.1	1919.2	540.6	1773.2	445.2	1460.3				
			2400K	109	601.6	1973.2	555.9	1823.4	457.8	1501.6				
			2700K	122	674.2	2211.3	622.2	2040.8	512.4	1680.7				
			3000K	129	712.9	2338.2	657.9	2157.9	541.8	1777.1				
			3500K	132	729.4	2392.5	673.2	2208.1	554.4	1818.4				
			4000K	132	729.4	2392.5	673.2	2208.1	554.4	1818.4				
6000K	126	696.3	2283.8	642.6	2107.7	529.2	1735.8							

**RIBBONLYTE SPECIFICATIONS & COMPATIBILITY**

Available Wattages	Cuttable Length	LED Pitch	Color Temp.	lm/W without Lens	Delivered Lumens with Clear Lens	Delivered Lumens with Frosted Lens	Delivered Lumens with Milky Lens	Max Length	Compatible with Channel		
									IP20	IP65	IP68
0.75 Static Color Series 2	1.97 in. (50 mm)	48 LEDs/ft (160 LEDs/m)	Red	41	28 lm/ft (93 lm/m)	26 lm/ft (86 lm/m)	22 lm/ft (70.6 lm/m)	IP20: 49 ft (15 m) IP65/ IP68: 32.8 ft (10 m)	✓	✓	✓
			Green	175	121 lm/ft (396 lm/m)	112 lm/ft (366 lm/m)	92 lm/ft (301.4 lm/m)				
			Blue	19	13 lm/ft (43 lm/m)	12 lm/ft (40 lm/m)	10 lm/ft (32.7 lm/m)				
			Amber	34	23 lm/ft (77 lm/m)	22 lm/ft (71 lm/m)	18 lm/ft (58.6 lm/m)				
1.5 Static Color Series 2	1.97 in. (50 mm)	48 LEDs/ft (160 LEDs/m)	Red	42	58 lm/ft (190 lm/m)	54 lm/ft (176 lm/m)	44 lm/ft (144.7 lm/m)	IP20: 49 ft (15 m) IP65/ IP68: 32.8 ft (10 m)	✓	✓	✓
			Green	160	221 lm/ft (724 lm/m)	204 lm/ft (669 lm/m)	168 lm/ft (551.1 lm/m)				
			Blue	18	25 lm/ft (81 lm/m)	23 lm/ft (75 lm/m)	19 lm/ft (62 lm/m)				
			Amber	34	47 lm/ft (154 lm/m)	43 lm/ft (142 lm/m)	36 lm/ft (117.1 lm/m)				
2.2 Static Color Series 2	1.97 in. (50 mm)	48 LEDs/ft (160 LEDs/m)	Red	42	85 lm/ft (279 lm/m)	79 lm/ft (258 lm/m)	65 lm/ft (212.2 lm/m)	IP20: 42 ft (12.8 m) IP65/ IP68: 32.8 ft (10 m)	✓	✓	✓
			Green	145	293 lm/ft (963 lm/m)	271 lm/ft (889 lm/m)	223 lm/ft (732.4 lm/m)				
			Blue	18	36 lm/ft (119 lm/m)	34 lm/ft (110 lm/m)	28 lm/ft (90.9 lm/m)				
			Amber	33	67 lm/ft (219 lm/m)	62 lm/ft (202 lm/m)	51 lm/ft (166.7 lm/m)				
3.0 Static Color Series 2	1.97 in. (50 mm)	48 LEDs/ft (160 LEDs/m)	Red	40.0	110.4 lm/ft (362.1 lm/m)	102.0 lm/ft (334.6 lm/m)	84.0 lm/ft (275.52 lm/m)	32.8 ft (10 m)	✓	✓	✓
			Green	127.0	350.9 lm/ft (1151.0 lm/m)	323.9 lm/ft (1062.2 lm/m)	266.7 lm/ft (874.776 lm/m)				
			Blue	25.0	69.1 lm/ft (226.6 lm/m)	63.8 lm/ft (209.1 lm/m)	52.5 lm/ft (172.2 lm/m)				
			Amber	29.0	80.1 lm/ft (262.8 lm/m)	74.0 lm/ft (242.6 lm/m)	60.9 lm/ft (199.752 lm/m)				
4.4 Static Color Series 2	1.97 in. (50 mm)	48 LEDs/ft (160 LEDs/m)	Red	38.0	153.8 lm/ft (504.5 lm/m)	142.1 lm/ft (466.2 lm/m)	117.0 lm/ft (383.8912 lm/m)	29 ft (8.8 m)	✓	✓	✓
			Green	117.0	474.1 lm/ft (1555.1 lm/m)	437.6 lm/ft (1435.3 lm/m)	360.4 lm/ft (1181.981 lm/m)				
			Blue	24.0	97.3 lm/ft (319.0 lm/m)	89.8 lm/ft (294.4 lm/m)	73.9 lm/ft (242.4576 lm/m)				
			Amber	25.0	101.3 lm/ft (332.2 lm/m)	93.5 lm/ft (306.7 lm/m)	77.0 lm/ft (252.56 lm/m)				
5.0 Static Color Series 2	1.4 in. (35.7 mm)	68 LEDs/ft (224 LEDs/m)	Red	37.0	170.2 lm/ft (558.2 lm/m)	157.3 lm/ft (515.8 lm/m)	129.5 lm/ft (424.76 lm/m)	30 ft (9.14 m)	✓	✓	✓
			Green	116.0	534.2 lm/ft (1752.1 lm/m)	493.0 lm/ft (1617.0 lm/m)	406.0 lm/ft (1331.68 lm/m)				
			Blue	24.0	110.5 lm/ft (362.5 lm/m)	102.0 lm/ft (334.6 lm/m)	84.0 lm/ft (275.52 lm/m)				
			Amber	26.0	119.7 lm/ft (392.7 lm/m)	110.5 lm/ft (362.4 lm/m)	91.0 lm/ft (298.48 lm/m)				
6.0 Static Color Series 2	1.4 in. (35.7 mm)	68 LEDs/ft (224 LEDs/m)	Red	37.0	204.2 lm/ft (669.8 lm/m)	188.7 lm/ft (618.9 lm/m)	155.4 lm/ft (509.712 lm/m)	28 ft (8.5 m)	✓	✓	✓
			Green	113.0	624.4 lm/ft (2048.2 lm/m)	576.3 lm/ft (1890.3 lm/m)	474.6 lm/ft (1556.688 lm/m)				
			Blue	23.0	127.1 lm/ft (416.9 lm/m)	117.3 lm/ft (384.8 lm/m)	96.6 lm/ft (316.9 lm/m)				
			Amber	24.0	132.6 lm/ft (435.0 lm/m)	122.4 lm/ft (401.6 lm/m)	100.8 lm/ft (330.7 lm/m)				
2.4 Static White Linea	1.97 in. (50 mm)	146 LEDs/ft (480 LEDs/m)	2700K	67	148.1 lm/ft (485.8 lm/m)	136.9 lm/ft (448.8 lm/m)	112.7 lm/ft (369.6 lm/m)	21.3 ft (6.5 m)	✓	N/A	N/A
			3000K	71	156.4 lm/ft (514.3 lm/m)	144.5 lm/ft (475.2 lm/m)	119 lm/ft (391.3 lm/m)				
			3500K	83	183.1 lm/ft (601.7 lm/m)	169.2 lm/ft (555.9 lm/m)	139.3 lm/ft (457.8 lm/m)				
			4000K	83	183.1 lm/ft (601.7 lm/m)	169.2 lm/ft (555.9 lm/m)	139.3 lm/ft (457.8 lm/m)				
3.0 Static White Linea	1.97 in. (50 mm)	146 LEDs/ft (480 LEDs/m)	2700K	66	182.2 lm/ft (598 lm/m)	168.3 lm/ft (552.5 lm/m)	138.6 lm/ft (455 lm/m)	21.3 ft (6.5 m)	✓	N/A	N/A
			3000K	73	201.5 lm/ft (661.5 lm/m)	186.2 lm/ft (611.2 lm/m)	153.3 lm/ft (503.3 lm/m)				
			3500K	78	215.3 lm/ft (706.6 lm/m)	198.9 lm/ft (652.8 lm/m)	163.8 lm/ft (537.6 lm/m)				
			4000K	83	229.1 lm/ft (751.6 lm/m)	211.7 lm/ft (694.5 lm/m)	174.3 lm/ft (571.9 lm/m)				
4.3 Static White Linea	1.97 in. (50 mm)	146 LEDs/ft (480 LEDs/m)	2700K	75	297.2 lm/ft (973.4 lm/m)	274.6 lm/ft (899.3 lm/m)	226.1 lm/ft (740.6 lm/m)	24.6 ft (7.5 m)	✓	N/A	N/A
			3000K	78	308.2 lm/ft (1012 lm/m)	284.8 lm/ft (935 lm/m)	234.5 lm/ft (770 lm/m)				
			3500K	86	340.4 lm/ft (1169.9 lm/m)	314.5 lm/ft (1031.9 lm/m)	259 lm/ft (849.8 lm/m)				
			4000K	86	340.4 lm/ft (1169.9 lm/m)	314.5 lm/ft (1031.9 lm/m)	259 lm/ft (849.8 lm/m)				
6.1 Variable White Linea	1.09 in. (27.78 mm)	175 LEDs/ft (576 LEDs/m)	2700K + 6500K	95	533.6 lm/ft (1750.8 lm/m)	493 lm/ft (1617.6 lm/m)	406 lm/ft (1332.1 lm/m)	16.4 ft (5 m)	✓	N/A	N/A



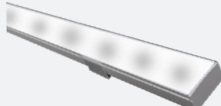

**RIBBONLYTE SPECIFICATIONS & COMPATIBILITY**

Available Wattages	Cutttable Length	LED Pitch	Color Temp.	lm/W without Lens	Delivered Lumens with Clear Lens	Delivered Lumens with Frosted Lens	Delivered Lumens with Milky Lens	Max Length	Compatible with Channel		
									IP20	IP65	IP68
1.0 Variable White Series 2	1.97 in. (50 mm)	42 LEDs/ft (140 LEDs/m)	2000K + 6500K	85.0	78.2 lm/ft (257 lm/m)	72.3 lm/ft (237 lm/m)	60 lm/ft (200 lm/m)	32.8 ft (10 m)	✓	✓	✓
3.0 Variable White Series 2	1.97 in. (50 mm)	42 LEDs/ft (140 LEDs/m)	2000K + 6500K	80.0	220.8 lm/ft (725 lm/m)	205.0 lm/ft (670 lm/m)	168.0 lm/ft (551.2 lm/m)	32.8 ft (10 m)	✓	✓	✓
6.0 Variable White Series 2	1.97 in. (50 mm)	42 LEDs/ft (140 LEDs/m)	2000K + 6500K	75.0	415 lm/ft (1,362 lm/m)	382.5 lm/ft (1255 lm/m)	315.0 lm/ft (1033.5 lm/m)	19 ft 8 in. (6 m)	✓	✓	✓
4.4 RGBW Series 2	1.97 in. (50 mm)	36 LEDs/ft (120 LEDs/m)	RGBW	45	188.1 lm/ft (617.2 lm/m) All LEDs at 100%	168.3 lm/ft (552.2 lm/m) All LEDs at 100%	148.5 lm/ft (487.2 lm/m) All LEDs at 100%	19 ft 8 in. (6 m)	✓	N/A	N/A
5.5 RGBW Series 2	1.97 in. (50 mm)	36 LEDs/ft (120 LEDs/m)	RGBW	59	308.8 lm/ft (1013.0 lm/m) All LEDs at 100%	275.8 lm/ft (904.9 lm/m) All LEDs at 100%	243.3 lm/ft (798.5 lm/m) All LEDs at 100%	16 ft 4 in. (5 m) IP68: 19 ft 7.9 in. (6 m)	N/A	✓	✓
8.8 RGBW Series 2	1.97 in. (50 mm)	36 LEDs/ft (120 LEDs/m)	RGBW	61	510.2 lm/ft (1673.8 lm/m) All LEDs at 100%	456.3 lm/ft (1497.1 lm/m) All LEDs at 100%	402.6 lm/ft (1320.9 lm/m) All LEDs at 100%	16 ft 4 in. (5 m)	✓	N/A	N/A
4.4 5-in-1 RGBWW	2.46 in. (62.5 mm)	29 LED/ft (96 LED/m)	RGBWW	59	241.4 lm/ft (792.1 lm/m) All LEDs at 100%	220.7 lm/ft (724.0 lm/m) All LEDs at 100%	194.7 lm/ft (638.8 lm/m) All LEDs at 100%	16 ft 4 in (5 m)	✓	N/A	N/A
8.8 5-in-1 RGBWW	2.46 in. (62.5 mm)	29 LED/ft (96 LED/m)	RGBWW	50	409.2 lm/ft (1342.6 lm/m) All LEDs at 100%	374.0 lm/ft (1227.1 lm/m) All LEDs at 100%	330.0 lm/ft (1082.7 lm/m) All LEDs at 100%	11 ft 6 in (3.5 m)	✓	N/A	N/A
RGBW Addressable	3.94 in. (100 mm)	18 LEDs/ft (60 LEDs/m)	Red	33.5	30.8 lm/ft (101.2 lm/m)	28.5 lm/ft (93.5 lm/m)	23.5 lm/ft (77 lm/m)	16 ft 5.64 in. (5.02 m)	N/A	N/A	✓ IP67
			Green	82	75.4 lm/ft (247.5 lm/m)	69.7 lm/ft (228.7 lm/m)	57.4 lm/ft (188.3 lm/m)				
			Blue	15.5	14.2 lm/ft (46.7 lm/m)	13.2 lm/ft (43.2 lm/m)	10.8 lm/ft (35.6 lm/m)				
			White	103	94.8 lm/ft (310.9 lm/m)	87.6 lm/ft (287.3 lm/m)	72.1 lm/ft (236.6 lm/m)				
			All	40	222.8 lm/ft (730.8 lm/m)	205.8 lm/ft (675.2 lm/m)	169.5 lm/ft (556.1 lm/m)				
5.2 Warm Dim	3.94 in. (100 mm)	36 LEDs/ft (120 LEDs/m)	WARM DIM	55	263.1 lm/ft (863 lm/m)	244.8 lm/ft (803.25 lm/m)	201.6 lm/ft (661.5 lm/m)	16 ft 4 in. (5 m)	✓	✓	✓









**DIODE VISIBILITY CHART** (Data below applies to installations with Milky lens only)

 <p><b>No Visible Diode = N</b> Note: Linea RibbonLyte has no visible diode</p>				 <p><b>With Visible Diode = Y</b></p>							
<b>Static White &amp; Static Color RibbonLyte</b>				<b>Color Changing RibbonLyte</b>							
<b>0.75/1.5/2.2</b>		<b>3.0/4.4</b>		<b>5.0/6.0</b>	<b>4.4 RGBW Series 2</b>	<b>5.5 RGBW Series 2</b>	<b>8.8 RGBW Series 2</b>	<b>4.4 5-in-1 RGBWW</b>	<b>8.8 5-in-1 RGBWW</b>	<b>Warm Dim</b>	<b>Variable White</b>
IP20 IP65 IP68	IP20 IP65	IP68	IP20 IP65 IP68	IP20 IP65 IP68	IP20	IP65 IP68	IP20	IP20	IP20	IP20 IP65 IP68	IP20 IP65 IP68
<b>Y</b>	<b>N</b>	<b>Y</b>	<b>N</b>	<b>Y</b>	<b>Y</b>	<b>Y</b>	<b>Y</b>	<b>Y</b>	<b>Y</b>	<b>Y</b>	<b>Y</b>

AVAILABLE DRIVERS / CONTROLLERS AND DIMMING OPTIONS / WIRE GAUGE CHART

NON-DIMMING ELECTRONIC DRIVERS			0-10V/ELV/MLV 3-IN-1		0-10V VW/WD	
						
<b>30W, 60W, 96W Non-Dimming Electronic Class 2 Drivers</b>  Part No.: • DRVW2430 (30 W) • DRVW2460 (60 W) • DRVW2496 (96 W)  24 VDC 120-277 VAC IP65, dry/damp locations UL Listed	<b>240W, 320W Non-Dimming Electronic Drivers</b>  Part No.: • DRVW24240 (240 W) • DRVW24320 (320 W)  24 VDC 90-305 VAC IP65, dry/damp locations UL Recognized	<b>60W, 96W Non-Dimming Compact Drivers</b>  Part No.: • DRV2460C (60 W) • DRV2496C (96 W)  24 VDC 120-277 VAC IP20, dry locations UL Class P	<b>60W, 96W, 288W 0-10V/ELV/MLV 3-in-1 Dimmable Drivers</b>  Part No.: • DRVW2460TRI010 (60 W) • DRVW2496TRI010 (96 W) • DRVW24288TRI010 (288 W)  24 VDC 120-277 VAC IP65, dry/damp/wet locations UL Listed		<b>0-10V Dimmable 90W VW/WD Driver</b>  Part No.: • DRVRFWDVW2490120  24 VDC 100-277 VAC IP23, dry/damp locations UL Listed	

ATHENA WIRELESS COMPATIBLE		CASAMBI COMPATIBLE DRIVERS		DIMMABLE DALI-2 DRIVERS		DIMMABLE DALI-2 DRIVERS	
							
<b>94W Athena Wireless Compatible Drivers</b>  Part No.: • DRVW2494ATH1CH (1 channel) • DRVW2494ATH2CH (2 channel)  24 VDC 100-277 VAC Dry locations UL Listed		<b>100W &amp; 200W Casambi Compatible 4 Channel Drivers</b>  Part No.: • DRVW24100CAS4CH (100 W) • DRVW24200CAS4CH (200 W)  24 VDC 100-277 VAC IP66, dry/damp/wet locations UL Listed, CE, RoHS, Bluetooth, CASAMBI		<b>96W DIMMABLE DALI-2 DT6 D4I &amp; DALI-2 DT8 D4I DRIVERS</b>  Part No.: • DRVW2496DALI1CH (1 channel) • DRVW2496DALI2CH (2 channel)  24-26 VDC 120-277 VAC IP67, dry/damp/wet locations UL Listed		<b>75W, 150W, 240W DALI-2 Dimmable Drivers</b>  Part No.: • DRVW2475DALI1CH (75 W, 1 channel) • DRVW24150DALI1CH (150 W, 1 channel) • DRVW24240DALI1CH (240 W, 1 channel) • DRV24150DALI2CH (150 W, 2 channels) • DRV24150DALI4CH (150 W, 4 channels)  24 VDC 120-277 VAC IP67, damp/wet locations (1-channel drivers only) IP20, dry location (2-channel & 4-channel drivers only) CE, RoHS, SELV	

DMX CONTROLLERS, VARIABLE WHITE DIMMER, WARM DIM DIMMER - FOR COLOR CHANGING FIXTURES					
					
<b>GLASS TOUCH WALL CONTROLLERS</b> Part No.: • AWCRCBWBK • AWCVWBK		<b>1 ZONE WALL CONTROLLER</b> Part No.: DMXCTRLG		<b>5 ZONE WALL CONTROLLER</b> Part No.: DMXCTRL	
					
<b>VARIABLE WHITE DIMMER</b> Part No.: • RFDIMVWWH (White) • RFDIMVWBK (Black)		<b>WARM DIM DIMMER</b> Part No.: • RFDIMWDWH (White) • RFDIMWDBK (Black)		<b>4 CHANNEL WATERPROOF DMX INTERFACE</b> Part No.: DMXINFWLCD4	
					
<b>6 UNIVERSE DMX CONTROLLER</b> Part No.: DMXCTRLDR6U		<b>5 CHANNEL DMX DECODER</b> Part No.: DMXINF5		<b>DMX OPTO SPLITTER</b> Part No.: DMXOS8	

Wattages	30		60		96		150		200		240		300		320	
	Feet	Meters	Feet	Meters	Feet	Meters	Feet	Meters	Feet	Meters	Feet	Meters	Feet	Meters	Feet	Meters
24 AWG / 0.25 mm <sup>2</sup>	14	4.27	9	2.74	5.5	1.68	3.75	1.14	2.75	0.84	2.25	0.69	1.75	0.53	1.75	0.53
22 AWG / 0.34 mm <sup>2</sup>	22	6.71	14	4.27	9	2.74	5.75	1.75	4.5	1.37	3.5	1.07	2.75	0.84	2.75	0.84
20 AWG / 0.5 mm <sup>2</sup>	35	10.67	23	7.01	14	4.27	9	2.74	7	2.13	5.75	1.75	4.5	1.37	4.25	1.30
18 AWG / 0.75 mm <sup>2</sup>	56	17.07	37	11.28	23	7.01	15	4.57	11	3.35	9	2.74	7.5	2.29	7	2.13
16 AWG / 1.5 mm <sup>2</sup>	90	27.44	60	18.29	37	11.28	24	7.32	18	5.49	15	4.57	12	3.66	11	3.35
14 AWG / 2.5 mm <sup>2</sup>	142	43.29	95	28.96	59	17.99	38	11.59	28	8.54	23	7.01	19	5.79	17	5.18
12 AWG / 4 mm <sup>2</sup>	226	68.90	151	46.04	94	28.66	60	18.29	45	13.72	37	11.28	30	9.15	28	8.54
10 AWG / 6 mm <sup>2</sup>	360	109.76	240	73.17	150	45.73	96	29.27	72	21.95	60	18.29	48	14.63	45	13.72
8 AWG / 10 mm <sup>2</sup>	574	175.00	381	116.16	239	72.87	153	46.65	115	35.06	95	28.96	76	23.17	71	21.65

WIRING DIAGRAMS - STATIC WHITE / STATIC COLOR / RGBW / RGBA / RGBWW

0-10 V

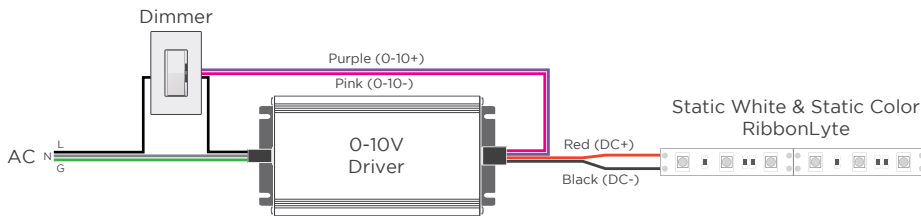

MLV / ELV

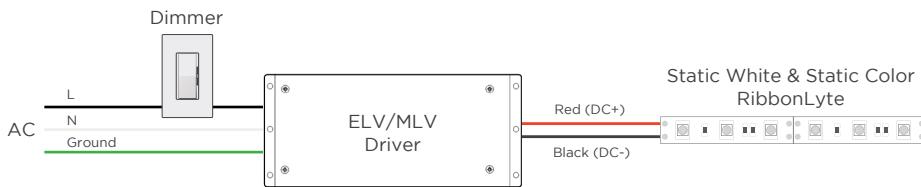

DMX WIRING WITH STATIC WHITE & STATIC COLOR RIBBONLYTE

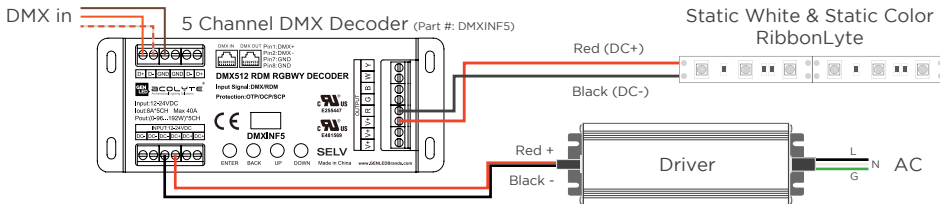

DALI-2 WIRING WITH STATIC WHITE & STATIC COLOR RIBBONLYTE

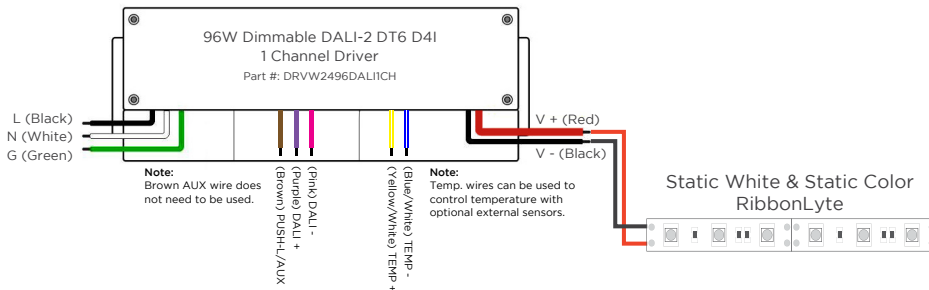

STATIC WHITE & STATIC COLOR RIBBONLYTE WIRING WITH ATHENA WIRELESS COMPATIBLE DRIVER

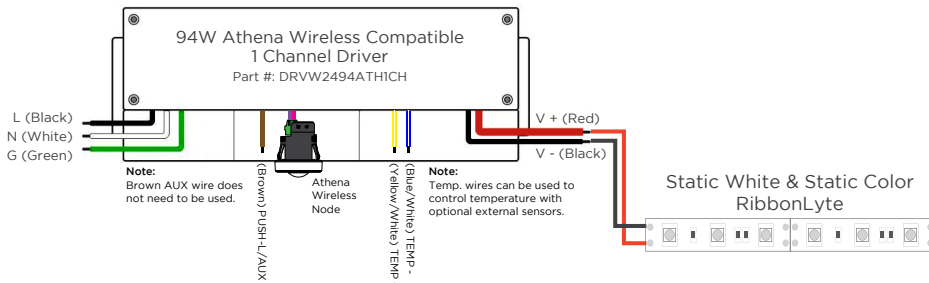

DMX WITH RGBWW 5-IN-1 RIBBONLYTE

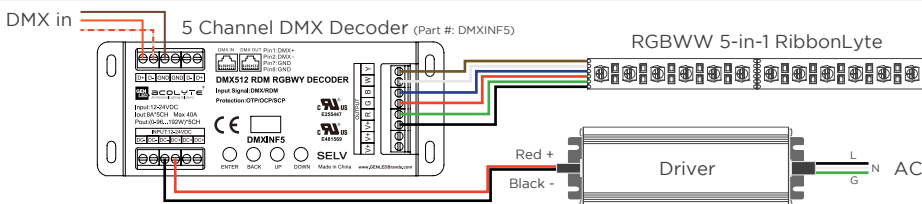

WIRE COLORS PER RIBBONLYTE COLOR

**STATIC WHITE + STATIC COLOR**

Red Wire (+) Positive  
Black Wire (-) Negative

**RGBW + RGBA**

Black Wire (+) Positive  
Green Wire (-) goes to Green Channel  
Red Wire (-) goes to Red Channel  
Blue Wire (-) goes to Blue Channel  
White Wire (-) goes to White Channel

**RGBWW**

Black (+) Positive  
Green Wire (-) goes to Green Channel  
Red Wire (-) goes to Red Channel  
Blue Wire (-) goes to Blue Channel  
White Wire (-) goes to White Channel 1  
Brown Wire (-) goes to White Channel 2







WIRING DIAGRAMS WITH RGBW ADDRESSABLE RIBBONLYTE

One DMX Universe consists of 128 addresses and 512 channels (42 ft / 12.8 m of RibbonLyte).

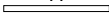
Any single run of RibbonLyte that is less than 16 ft, 4 in. can be wired directly to the controller.

For additional runs, Opto Splitter must be used. Each individual run will need its own Opto Splitter output.

WIRE INDEX	
+	
PI	
A+	
B-	
GND	

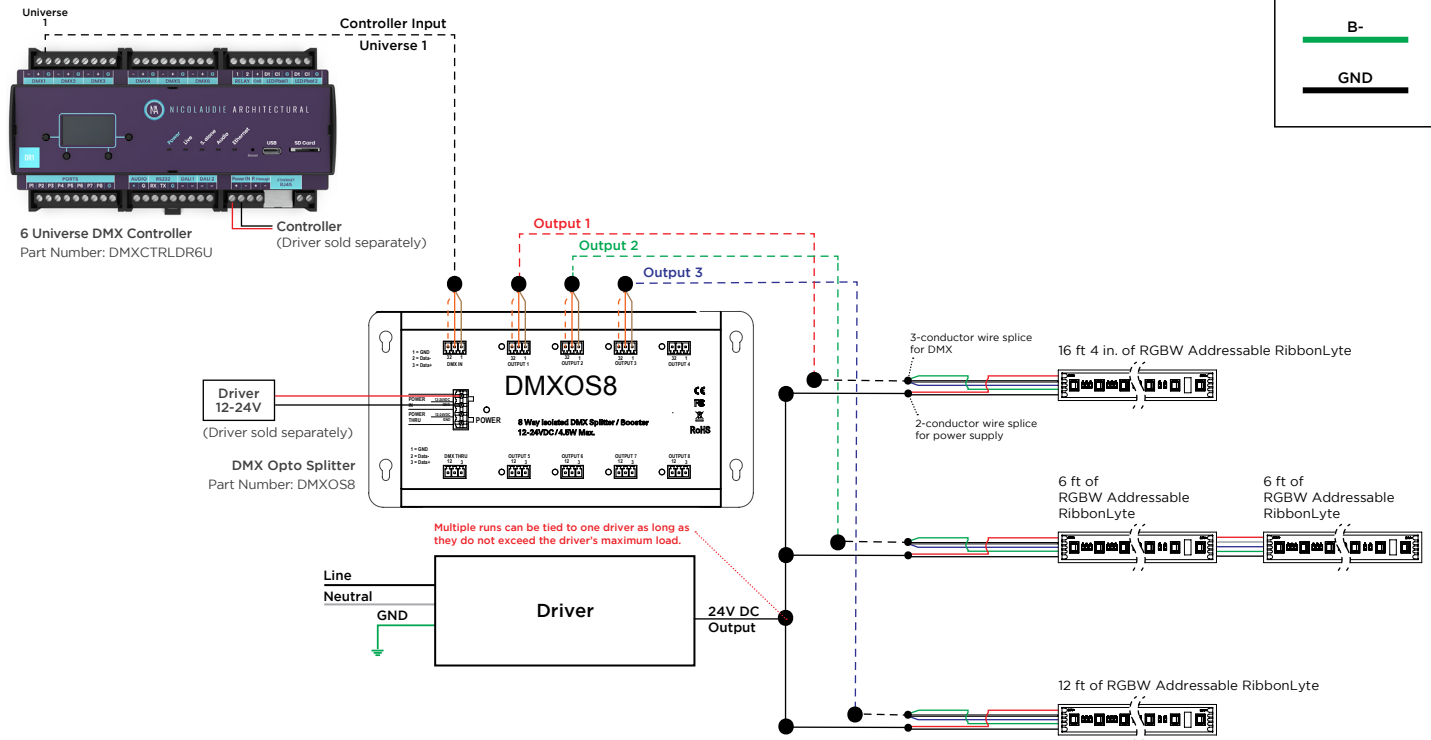

REV.08MAY2026

**GLOBAL HQ**

320 Murray Hill Pkwy  
East Rutherford, NJ 07073  
U.S.  
T: (+1) 212 629 6830  
E: Sales-US@GENLEDBrands.com

**EUROPEAN HQ**

Hogeweyselaan 119  
1382 JK Weesp  
Netherlands  
T: (+31) 346 235 000  
E: SalesEurope@GENLEDBrands.com

**MEINA HQ**

PO Box 371378, #823, Building 4EA  
Dubai Airport Free Zone  
Dubai, UAE  
T: (+971) 4 701 7901  
E: SalesMEINA@genledbrands.com

**ASIA-PACIFIC HQ**

Room 402, Building D  
Shenshi Tongchuang Science and Technology Park  
No. 16 Hongyin Road  
Xingqiang Community, Xihu Street  
Guangming District, Shenzhen, China 518107  
T: (+86) 755 8529 0710  
E: Sales-Pacific@GENLEDBrands.com