

AR9 CHANNEL FIXTURE

Our AR9 Channel Fixture is a recessed mounted linear fixture designed to work with the new Micro RibbonLyte 1.0, 3.0 & 4.5. AR9's ultra slim width of 0.31 in. (8 mm) can create clean and modern linear designs for retail stores, commercial buildings and residential interiors.

- Available for field assembly or factory assembly
- Beam Angle 110°
- Wattage: 1.0 W/ft (3.3 W/m), 3.0 W/ft (9.84 W/m) or 4.5 W/ft (14.76 W/m)
- Delivered Lumen Range from 1 lm/ft (3 lm/m) to 500 lm/ft (1638 lm/m)
- Assembled in USA

HOUSING FINISHES

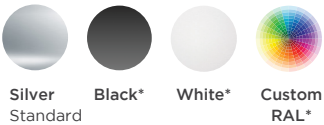

*Additional fee applies

AVAILABLE LENS FINISHES



Milky Lens
63% Light Transmission

AVAILABLE COLORS & COLOR TEMPERATURES

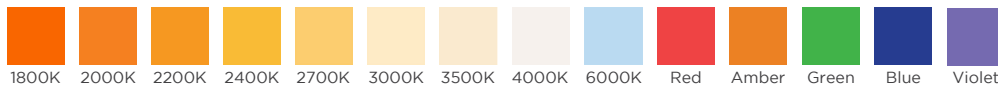

DIMENSIONS

AR9 Channel

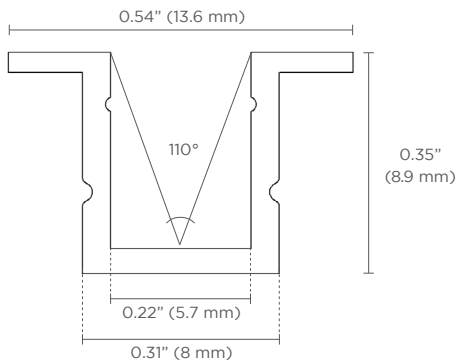

Overall Width: 0.54 in. (13.6 mm)
Recessed Width: 0.31 in. (8 mm)
Height: 0.35 in. (8.9 mm)
Internal Width: 0.22 in (5.7 mm)

- Note:**
1. This channel does not require mounting clips. Please see our installation guide for instructions.
 2. **Exterior channel applications** should be securely attached to the mounting surface with appropriate screws and/or liquid nails. Acolyte strongly recommends field assembly for exterior applications.

Acolyte does not warrant or represent that the information is free from errors or omission. The information may change without notice and Acolyte is not in any way liable for the accuracy of any information printed and stored or in any way interpreted or used.



SPECIFICATIONS

Beam Angle	110°
Lens Type	Milky Lens
Length	Channel is sold by the foot and cut to your exact desired length
Operating Voltage	24V
Dimming	MLV / 0-10 Volt / Lutron Hi-Lume 1% dimming LED drivers / Lutron VIVE code compliance available / ELV / DALI / DMX
Operating Temperature	-40° F to 158° F (-40° C to 70° C)
Colors	1800K, 2000K, 2200K, 2400K, 2700K, 3000K, 3500K, 4000K, 6000K, Red, Amber, Green, Blue, Violet (1800K, 2000K, 2200K only available in IP20)
CRI	90+ CRI (Static white only)
Lamp Life	L70 at 50,000 Hours
MacAdam Ellipses (SDCM)	2-Step Binning (For Static White LEDs only)
Certifications	ETL Listed: UL 2108 Issued: 2004/02/27 Ed: 1 Rev: 2014/02/24 Low Voltage Lighting Systems CSA C22.2#9.0 Issued: 1996/06/01 Ed: 1 (R2011) General Requirements for Luminaires; with Gen. Inst. 1: 1997, Gen Inst. 2: 1998. ROHS compliant UL 2108 - Low Voltage Lighting Systems UL 8750 - Light Emitting Diode (LED) Equipment for Use in Lighting Products UL 1598 / CSA 250.0-08 - Luminaires

Acolyte does not warrant or represent that the information is free from errors or omission. The information may change without notice and Acolyte is not in any way liable for the accuracy of any information printed and stored or in any way interpreted or used.

ORDERING GUIDE

STEP 1 Complete Channel Part Number

CHANNEL	LENS	HOUSING COLOR	
CHAR9	M		
CHAR9 - AR9 Channel Fixture	M - Milky Lens	SV - Silver (default) BK - Black	WH - White
Consult factory for custom colors			

STEP 2 Complete RibbonLyte Part Number

CATEGORY	CRI	RIBBON TYPE & IP RATING	
RB			
RB - RibbonLyte	0 - Static Color, Color Changing 90 - 90+ CRI Static White	SWMC20 - Static White Micro IP20 SWMC65 - Static White Micro IP65	SCMC20 - Static Color Micro IP20 SCMC65 - Static Color Micro IP65

WATTAGE	COLOR
1.0 - 1.0 W/ft (3.3 W/m - Static White, Static Color)	18 - 1800K R - Red
3.0 - 3.0 W/ft (9.8 W/m - Static White, Static Color)	20 - 2000K A - Amber
4.5 - 4.5 W/ft (14.8 W/m - Static White, Static Color)	22 - 2200K G - Green
	24 - 2400K B - Blue
	27 - 2700K V - Violet
	30 - 3000K Z - Undecided**
	35 - 3500K ** For quotes only. Must be chosen before final order.
	40 - 4000K
	60 - 6000K

NOTE: To ensure waterproofing standards are met, IP65 RibbonLyte can NOT be cut in the field.

CONNECTION OPTIONS (See diagrams on the right)

- 1 - Back Feed Bare Wire Connection
- 2 - Back Feed with IP67 Male Coupler
- 3 - Soldered Daisy Chain
- 4 - Daisy Chain With IP67 Couplers

Custom Length (ft.)

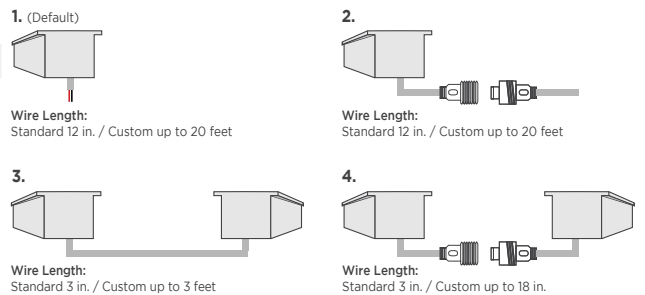

STEP 3 Complete Assembly Option & Length

ASSEMBLY OPTION	LENGTH (Standard factory assembled length up to 78 in. / 2 m)
FI - Field Assembly	
FA - Factory Assembly*	* Factory assembly is not recommended for exterior applications

RIBBONLYTE SPECIFICATIONS & COMPATIBILITY

Available Wattages	Cuttable Length	LED Pitch	Color Temperature	lm/W without Lens	Delivered Lumens with Milky Lens	Max Length	Compatible with Channel	
							IP20	IP65
1.0 Static White Micro & 1.0 Static Color Micro	1.97 in. (50 mm)	43 LEDs/ft (140 LEDs/m)	2400K	79	49.8 lm/ft (163.3 lm/m)	28 ft (8.5 m)	✓	✓
			2700K	90	56.7 m/ft (186 lm/m)			
			3000K	94	59.2 lm/ft (194 lm/m)			
			3500K	98	61.7 lm/ft (202.5 lm/m)			
			4000K	97	61.1 lm/ft (200.5 lm/m)			
			6000K	93	58.6 lm/ft (192.2 lm/m)			
			Red	27	16.8 lm/ft (55.0 lm/m)			
			Green	78	49.2 lm/ft (161.3 lm/m)			
			Blue	17	10.6 lm/ft (34.9 lm/m)			
			Amber	19	11.8 lm/ft (38.8 lm/m)			
			Violet	1	0.3 lm/ft (1.0 lm/m)			
			3.0 Static White Micro & 3.0 Static Color Micro	1.97 in. (50 mm)	43 LEDs/ft (140 LEDs/m)			
2700K	90	170.1 lm/ft (557.9 lm/m)						
3000K	94	177.7 lm/ft (582.7 lm/m)						
3500K	98	185.2 lm/ft (607.5 lm/m)						
4000K	97	183.3 lm/ft (601.3 lm/m)						
6000K	93	175.8 lm/ft (576.5 lm/m)						
Red	27	50.3 lm/ft (164.9 lm/m)						
Green	78	147.5 lm/ft (483.9 lm/m)						
Blue	17	31.9 lm/ft (104.6 lm/m)						
Amber	19	35.5 lm/ft (116.4 lm/m)						
Violet	1	0.9 lm/ft (2.9529lm/m)						
4.5 Static White Micro & 4.5 Static Color Micro	1.97 in. (50 mm)	43 LEDs/ft (140 LEDs/m)				2400K	80	223.5 lm/ft (733.2 lm/m)
			2700K	88	247.8 lm/ft (812.7 lm/m)			
			3000K	93	259.8 lm/ft (852.2 lm/m)			
			3500K	87	244.7 lm/ft (802.6 lm/m)			
			4000K	97	268.2 lm/ft (879.7 lm/m)			
			6000K	94	263.1 lm/ft (862.9 lm/m)			
			Red	26	73.5 lm/ft (241.1 lm/m)			
			Green	83	243.8 lm/ft (799.9 lm/m)			
			Blue	17	52.8 lm/ft (173.2 lm/m)			
			Amber	17	51.7 lm/ft (169.6 lm/m)			
			Violet	1	1.4 lm/ft (4.5 lm/m)			

DIODE VISIBILITY CHART (Data below applies to installations with Milky lens only)

	No Visible Diode = N		With Visible Diode = Y
Static White & Static Color Micro RibbonLyte			
1.0		3.0	4.5
IP20 IP65		IP20 IP65	IP20 IP65
N		N	N

AVAILABLE DRIVERS

NON-DIMMING ELECTRONIC DRIVERS



**30W, 60W, 96W
Non-Dimming Electronic
Class 2 Drivers**

Part No.:

- DRVW2430 (30 Watt)
- DRVW2460 (60 Watt)
- DRVW2496 (96 Watt)

Output Voltage: 24 V
Voltage Range: 120-277 VAC
IP Rating: Dry or Damp
UL Listed



**240W, 320W
Non-Dimming
Electronic Drivers**

Part No.:

- DRVW24240 (240 Watt)
- DRVW24320 (320 Watt)

Output Voltage: 24 V
Voltage Range: 90-305 VAC
IP Rating: Dry or Damp
UL Recognized

ELV & MLV DRIVERS WITH COMPATIBLE DIMMERS



**60W, 96W, 150W, 300W
ELV/MLV Dimmable Drivers**

Part No.:

- DRVW2460ELVMLV (60 Watt)
- DRVW2496ELVMLV (96 Watt)
- DRVW24150ELVMLV (150 Watt)
- DRVW24300ELVMLV (300 Watt)

Line Voltage Dimmable Drivers
Output Voltage: 24 V
Voltage Range: 100-277 VAC
IP Rating: IP67
Dimmable
UL, CE, and CSA Listed



LUTRON Skylark Contour Dimmer

Part No.: TRIDIMSKY

Width: 2.94 in (75 mm)
Length: 4.69 in (120 mm)
Depth: 0.30 in (7.6 mm)

- Single pole and 3-way versions
- Compatible with Acolyte MLV drivers
- Slide adjusts brightness and On/Off control
- 30 mA max control current
- Available in white finish



LUTRON NOVA-T Dimmer

Part No.: TRIDIMNOVA

Width: 2.75 in (70 mm)
Length: 4.56 in (116 mm)
Depth: 0.30 in (7.6 mm)

- Slide adjusts brightness and On/Off control
- 30 mA max control current
- Available in white finish



LUTRON DIVA Dimmer

Part No.: TRIDIMDIVA

(With Locator Light) TRIDIMDIVAL

Width: 2.94 in (75 mm)
Length: 4.69 in (120 mm)
Depth: 0.30 in (7.6 mm)

- Large paddle switch with a captive linear-slide dimmer
- 30 mA max control current
- Available in white finish
- Available with locator light which glows green when the switch is off

Note: For more options, please reference the Optional Dimmer List on Acolyte product website page.

AVAILABLE DRIVERS / CONTROLLERS AND DIMMING OPTIONS / WIRE GAUGE CHART

0-10V DRIVERS AND DIMMERS



0-10V Dimmable Waterproof Drivers

96W Part No.: DRVW249610P
288W Part No.: DRVW2428810P
 Output Voltage: 24 V (+/- 0.5V)
 Voltage Range: 100-277 VAC
 Environmental Rating: UL Wet Location
 UL Listed



LUTRON DIVA Dimmer

Part No.: LVDIMDIVA
 Width: 2.94 in (75 mm)
 Length: 4.69 in (120 mm)
 Depth: 0.30 in (7.6 mm)

- Compatible with 0-10 V Dimming Module
- Large paddle switch with a captive linear-slide dimmer
- 30 mA max control current
- Available in white finish



LUTRON NOVA-T Dimmer

Part No.: LVDIMNOVA
 Width: 2.75 in (70 mm)
 Length: 4.56 in (116 mm)
 Depth: 0.30 in (7.6 mm)

- Compatible with 0-10 V Dimming Module
- Slide adjusts brightness and On/Off control
- 30 mA max control current
- Available in white finish

DRIVER AND RIBBONLYTE AT FULL LOAD

Wattages	30		60		96		150		200		240		300		320	
	Feet	Meters	Feet	Meters	Feet	Meters	Feet	Meters	Feet	Meters	Feet	Meters	Feet	Meters	Feet	Meters
24 AWG	14	4.27	9	2.74	5.5	1.68	3.75	1.14	2.75	0.84	2.25	0.69	1.75	0.53	1.75	0.53
22 AWG	22	6.71	14	4.27	9	2.74	5.75	1.75	4.5	1.37	3.5	1.07	2.75	0.84	2.75	0.84
20 AWG	35	10.67	23	7.01	14	4.27	9	2.74	7	2.13	5.75	1.75	4.5	1.37	4.25	1.30
18 AWG	56	17.07	37	11.28	23	7.01	15	4.57	11	3.35	9	2.74	7.5	2.29	7	2.13
16 AWG	90	27.44	60	18.29	37	11.28	24	7.32	18	5.49	15	4.57	12	3.66	11	3.35
14 AWG	142	43.29	95	28.96	59	17.99	38	11.59	28	8.54	23	7.01	19	5.79	17	5.18
12 AWG	226	68.90	151	46.04	94	28.66	60	18.29	45	13.72	37	11.28	30	9.15	28	8.54
10 AWG	360	109.76	240	73.17	150	45.73	96	29.27	72	21.95	60	18.29	48	14.63	45	13.72
8 AWG	574	175.00	381	116.16	239	72.87	153	46.65	115	35.06	95	28.96	76	23.17	71	21.65

WIRING DIAGRAM

0-10V

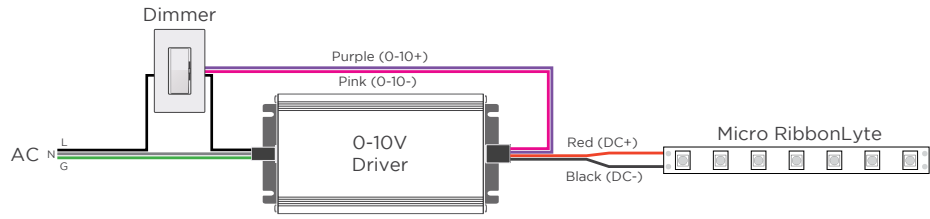

MLV / ELV

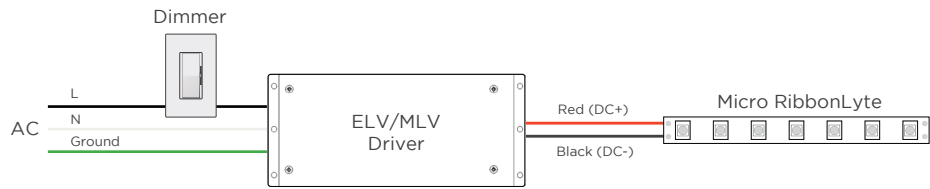

DMX

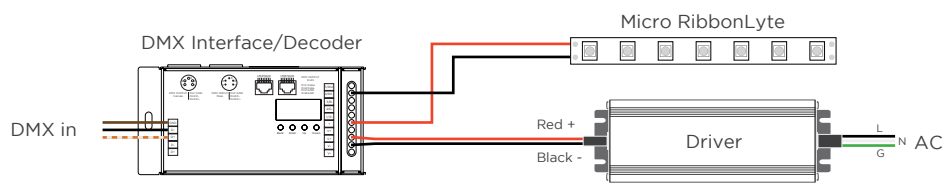

WIRE COLORS PER RIBBONLYTE COLOR

- STATIC WHITE + STATIC COLOR MICRO
- Red Wire (+) Positive
- Black Wire (-) Negative