

AS13 CHANNEL FIXTURE

The AS13 is a shallow aluminum surface mounted channel available with round milky or square milky lens. This sleek, wide channel mounts flush to the surface. Create a custom fixture with AS13, your choice of round milky or square milky lenses and our RibbonLyte products.

- Available for field assembly or factory assembly
- 1.31 in. (33.4 mm) wide by 1.29 in. (32.7 mm) deep with round lens, 1.37 in. (34.8 mm) deep with square lens
- Beam angles: 100x140° with Round Lens, 100x150° with Square Lens
- Wattage Range from 0.75 W/ft (2.46 W/m) to 12 W/ft (39.4 W/m)
- Static White delivered lumen range: 47 lm/ft (155 lm/m) up to 975 lm/ft (3199 lm/m)
- Round Milky Lens or Square Milky Lens
- For interior applications only

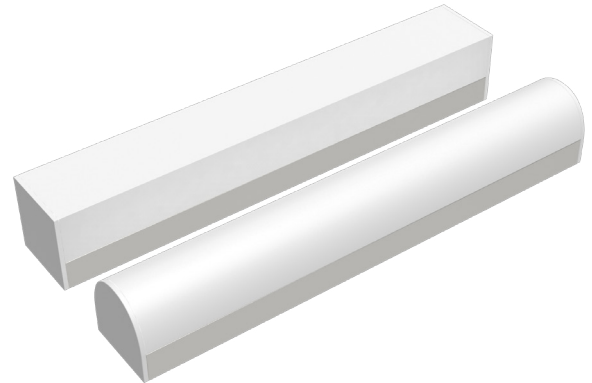

HOUSING FINISHES

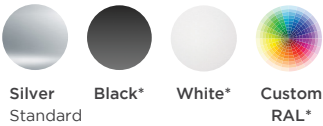

*Additional fee applies

LENS FINISHES

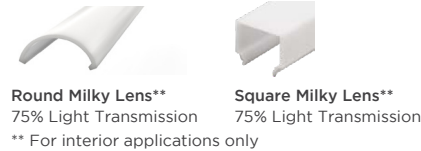

AVAILABLE COLORS & COLOR TEMPERATURES



DIMENSIONS

AS13 Channel	Mounting Clip (included accessory)
<p>Width: 1.31 in. (33.4 mm) Height: 1.29 in. (32.7 mm) Internal Width: 1.22 in. (31 mm) Internal Height: 1 in. (25.3 mm)</p> <p>Width: 1.31 in. (33.4 mm) Height: 1.37 in. (34.8 mm) Internal Width: 1.22 in. (31 mm) Internal Height: 1.07 in. (27.3 mm)</p>	<p>Material: stainless steel</p> <p>Side View 0.14 in. (3.5 mm) height, 0.74 in. (18.8 mm) width</p> <p>Top View 0.87 in. (22 mm) length</p> <p>Assembled View 1.29 in. (32.7 mm) height (Round Lens) 1.37 in. (34.8 mm) height (Square Lens)</p> <p>Width: 0.74 in. (18.8 mm) Length: 0.87 in. (22 mm)</p> <p>Note: 1. Raised lenses are for interior applications only 2. Magnetic mounting option available (see page 2)</p>

Acolyte does not warrant or represent that the information is free from errors or omission. The information may change without notice and Acolyte is not in any way liable for the accuracy of any information printed and stored or in any way interpreted or used.

SPECIFICATIONS

Beam Angle	100x140° with Round Milky Lens, 100x150° with Square Milky Lens
Lens Type	Round Milky Lens, Square Milky Lens
Length	Channel is sold by the foot and cut to your exact desired length. Required amount of mounting clips included.
Operating Voltage	24 V
Dimming	MLV / 0-10 Volt / ELV / DALI / DMX / CASAMBI
Operating Temperature	-40 – 158 °F (-40 – 70 °C)
Colors	1800K, 2000K, 2200K, 2400K, 2700K, 3000K, 3500K, 4000K, 6000K, Red, Amber, Green, Blue, RGBA, RGBW, RGBWW, VW, Pixel RGB, RGBW Addressable, Warm Dim (1800K, 2000K, 2200K, Pixel RGB only available in IP20)
CRI	90+ CRI (for Static White LEDs only)
Lamp Life	L70 at 50,000 hours
MacAdam ellipse (SDCM)	1-Step Binning (for Static White LEDs only)
Certifications	UL Listed UL 2108 Issued: 2004/02/27 Ed: 1 Rev: 2014/02/24 Low Voltage Lighting Systems CSA C22.2#9.0 Issued: 1996/06/01 Ed: 1 (R201) General Requirements for Luminaries; with Gen. Inst. 1: 1997, Gen Inst. 2: 1998. ROHS compliant

ACCESSORIES (SEE PART NUMBERS AT STEP 4 ON PAGE 3)

End Cap (D) for channel with Round Lens	End Cap (E) for channel with Square Lens	Tiltable Stand
Material: ABS	Material: ABS	
<p>End Cap options when using channel with Round Lens or Square Lens:</p> <ol style="list-style-type: none"> Use End Cap (D) for channel with Round Lens Use End Cap (E) for channel with Square Lens 		<p>Assembled Height with channel & Round Lens: 2.15 in. (54.5 mm)</p> <p>Assembled Height with channel & Square Lens: 2.23 in. (56.6 mm)</p>

Magnetic Mount (Part #: CHMAGO.5)

Features:

- High-energy neodymium magnets come attached to mounting clips with countersink hex nuts
- Create easy-mount magnetic channels with minimal surface gaps; no tools or drilling necessary
- Magnets rated for 8 lbs. of pull force with static load

Applications:

- Industrial lighting retrofits for troffers and other metal fixtures
- Metal retail shelf lighting
- Temporary light fixture installations

With Square Lens: 1.5 in. (37.98 mm)

With Round Lens: 1.41 in. (35.9 mm)

Acolyte does not warrant or represent that the information is free from errors or omission. The information may change without notice and Acolyte is not in any way liable for the accuracy of any information printed and stored or in any way interpreted or used.

ORDERING GUIDE

STEP 1 Complete Channel Part Number

CHANNEL	LENS	HOUSING COLOR	END CAPS
CHAS13			
CHAS13 - AS13 Channel	RM - Round Milky Lens* SM - Square Milky Lens* * For interior applications only	SV - Silver (standard) BK - Black** WH - White** ** Additional fee applies Consult factory for custom colors	D - End Cap for channel with Round Milky Lens E - End Cap for channel with Square Milky Lens

STEP 2 Complete RibbonLyte Part Number

CATEGORY	CRI	RIBBON TYPE & IP RATING		
RB				
RB - RibbonLyte	0 - Static Color, Color Changing 90 - 90+ CRI Static White	SWS220 - Static White Series 2 IP20 SWS265 - Static White Series 2 IP65 SWS268 - Static White Series 2 IP68 SWDR20 - Static White Double Row IP20 SCS220 - Static Color Series 2 IP20 SCS265 - Static Color Series 2 IP65 SCS268 - Static Color Series 2 IP68 LINEA20 - Linea RibbonLyte IP20	RGBWW20 - RGBWW 5-in-1 IP20 RGBWS220 - RGBW Series 2 IP20 RGBWS265 - RGBW Series 2 IP65 RGBWS268 - RGBW Series 2 IP68 RGBWADD - Addressable RGBW IP67 RGBWADR20 - RGBW/A Double Row IP20 VWDR20 - Variable White Double Row IP20 XACTA20 - Xacta RibbonLyte IP20	VWS220 - VW Series 2 IP20 VWS265 - VW Series 2 IP65 VWS268 - VW Series 2 IP68 WD20 - Warm Dim IP20 WD65 - Warm Dim IP65 WD68 - Warm Dim IP68

NOTE: To ensure waterproofing standards are met, IP65, IP67, and IP68 RibbonLyte can NOT be cut in the field.

WATTAGE

- 0.75 - 0.75 W/ft (2.46 W/m - Static White, Static Color)
- 1.0 - 1.0 W/ft (3.3 W/m - Variable White)
- 1.5 - 1.5 W/ft (4.9 W/m - Static White, Static Color)
- 2.2 - 2.2 W/ft (7.2 W/m - Static White, Static Color)
- 2.4 - 2.4 W/ft (8 W/m - Static White Linea)
- 3.0 - 3.0 W/ft (9.8 W/m - Static White, Static Color, Variable White, RGBW, RGBA)
- 4.3 - 4.3 W/ft (14 W/m - Static White Linea)
- 4.4 - 4.4 W/ft (14.4 W/m - Static White, Static Color, RGBW, RGBWW,, RGBA)
- 4.5 - 4.5 W/ft (14.8 W/m - Static White, Variable White)
- 5.0 - 5.0 W/ft (16.4 W/m - Static White, Static Color)
- 5.2 - 5.2 W/ft (17.1 W/m - Warm Dim)
- 5.5 - 5.5 W/ft (18.0 W/m - RGBW, RGBA)
- 6.0 - 6.0 W/ft (19.7 W/m - Static White, Static Color, Variable White, RGBW, RGBA, RGBW Addressable)
- 6.1 - 6.1 W/ft (20 W/m - Variable White Linea, Pixel RGB)
- 8.8 - 8.8 W/ft (28.9 W/m - RGBW, RGBWW, RGBA)
- 12.0 - 12.0 W/ft (39.4 W/m - Static White, Variable White, RGBW, RGBA)

COLOR

- 18 - 1800K RGB27 - Red, Green, Blue + 2700K
 - 20 - 2000K RGB30 - Red, Green, Blue + 3000K
 - 22 - 2200K RGB40 - Red, Green, Blue + 4000K
 - 24 - 2400K RGB2465 - Red, Green, Blue + 2400K + 6500K
 - 27 - 2700K RGBA - Red, Green, Blue + Amber
 - 30 - 3000K RGBW30 - RGB + 3000K Addressable
 - 35 - 3500K RGBW40 - RGB + 4000K Addressable
 - 40 - 4000K RGBW60 - RGB + 6000K Addressable
 - 60 - 6000K VW - Variable White (2000K-6500K)
 - R - Red VW1833 - Variable White 1800K-3300K (IP20 only)
 - A - Amber 2920 - Warm Dim 2900K-2000K (IP20)
 - G - Green 2721 - Warm Dim 2700K - 2100K (IP65/IP68)
 - B - Blue Z - Undecided**
- ** For quotes only. Must be chosen before final order.

CONNECTION OPTIONS (See diagrams on the right)

Custom Length (ft.)

- 1 - End Feed Bare Wire Connection
- 2 - Back Feed Bare Wire Connection
- 3 - End Feed with IP67 Male Coupler
- 4 - Soldered Daisy Chain
- 5 - Daisy Chain With IP67 Couplers

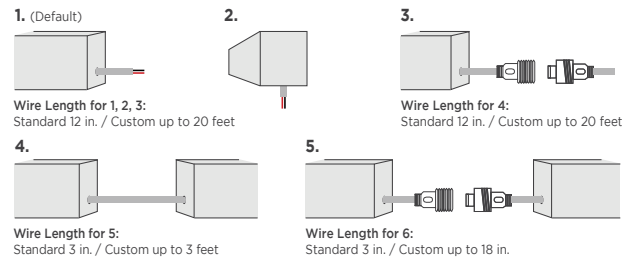

DO NOT BUTT END CAPS AGAINST EACH OTHER WHEN CREATING LONGER FIXTURES
Acolyte STRONGLY SUGGESTS field assembly (without using interior end caps) for direct-view fixtures of more than 6 ft 6.7 in. (2 m) in length. Field assembly without interior end caps will eliminate gaps or dead spots that can be caused by butting interior end caps against each other.

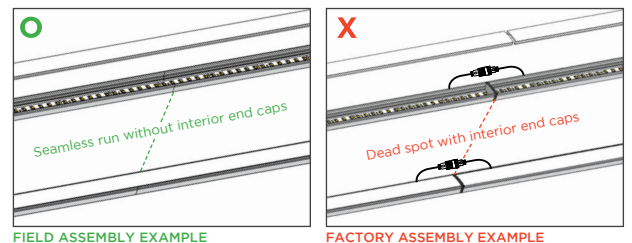

STEP 3 Complete Assembly Option & Length

ASSEMBLY OPTION LENGTH (Standard factory assembled length up to 6 ft 6.7 in. / 2 m)

- FI - Field Assembly
- FA - Factory Assembly*

* Factory assembled runs exceeding 6 ft 6.7 in. (2 m) will be split into multiple daisy chained fixtures.

STEP 4 Add Accessories

ACCESSORIES

- TILTSTANDST - Tiltable Stand
- CHMAG0.5 - Magnetic Mount

RIBBONLYTE SPECIFICATIONS & COMPATIBILITY

Available Wattage	Cutable Length	LED Pitch	Color Temp.	lm/W without Lens	Delivered Lumens with Round Milky Lens		Delivered Lumens with Square Milky Lens		Max Length	Compatible with Channel		
					lm/ft	lm/m	lm/ft	lm/m		IP20	IP65	IP68
0.75 Static White Series 2	1.97 in. (50 mm)	48 LEDs/ft (160 LEDs/m)	1800K	84	47	155	47	155	IP20: 49 ft (15 m) IP65/IP68: 32.8 ft (10 m)	✓	✓	✓
			2000K	99	56	183	56	183				
			2200K	109	61	201	61	201				
			2400K	113	64	209	64	209				
			2700K	123	69	227	69	227				
			3000K	123	69	227	69	227				
			3500K	130	73	240	73	240				
			4000K	134	75	247	75	247				
6000K	131	74	242	74	242							
1.5 Static White Series 2	1.97 in. (50 mm)	48 LEDs/ft (160 LEDs/m)	1800K	84	95	310	95	310	IP20: 49 ft (15 m) IP65/IP68: 32.8 ft (10 m)	✓	✓	✓
			2000K	98	110	362	110	362				
			2200K	109	123	402	123	402				
			2400K	113	127	417	127	417				
			2700K	123	138	454	138	454				
			3000K	123	138	454	138	454				
			3500K	129	145	476	145	476				
			4000K	134	151	495	151	495				
6000K	131	147	484	147	484							
2.2 Static White Series 2	1.97 in. (50 mm)	48 LEDs/ft (160 LEDs/m)	1800K	83	137	449	137	449	IP20: 42 ft (12.8 m) IP65/IP68: 32.8 ft (10 m)	✓	✓	✓
			2000K	96	158	520	158	520				
			2200K	106	175	574	175	574				
			2400K	111	183	601	183	601				
			2700K	120	198	650	198	650				
			3000K	122	201	660	201	660				
			3500K	127	210	684	210	684				
			4000K	133	219	720	219	720				
6000K	128	211	693	211	693							
3.0 Static White Series 2	1.97 in. (50 mm)	48 LEDs/ft (160 LEDs/m)	1800K	84	189	620	189	620	IP20: 36 ft (11 m) IP65/IP68: 32.8 ft (10 m)	✓	✓	✓
			2000K	98	221	723	221	723				
			2200K	108	243	797	243	797				
			2400K	109.8	247	811	247	811				
			2700K	122.9	277	907	277	907				
			3000K	130	293	960	293	960				
			3500K	133	299	982	299	982				
			4000K	133	299	982	299	982				
6000K	128	288	945	288	945							
4.4 Static White Series 2	1.97 in. (50 mm)	48 LEDs/ft (160 LEDs/m)	1800K	81	267	877	267	877	28 ft 4 in. (8.64 m)	✓	✓	✓
			2000K	95	314	1029	314	1029				
			2200K	105	347	1137	347	1137				
			2400K	109	360	1180	360	1180				
			2700K	122	403	1321	403	1321				
			3000K	129	426	1397	426	1397				
			3500K	132	436	1429	436	1429				
			4000K	132	436	1429	436	1429				
6000K	126	416	1364	416	1364							
5.0 Static White Series 2	1.4 in. (35.7 mm)	68 LEDs/ft (224 LEDs/m)	1800K	83	311	1021	311	1021	IP20: 33 ft 4 in. (10.1 m) IP65/IP68: 32.8 ft (10 m)	✓	✓	✓
			2000K	98	368	1206	368	1206				
			2200K	107	401	1316	401	1316				
			2400K	110	412	1351	412	1351				
			2700K	123	461	1512	461	1512				
			3000K	130	488	1599	488	1599				
			3500K	133	499	1636	499	1636				
			4000K	133	499	1636	499	1636				
6000K	127	476	1562	476	1562							
6.0 Static White Series 2	1.4 in. (35.7 mm)	68 LEDs/ft (224 LEDs/m)	1800K	82	369	1211	369	1211	28 ft (8.5 m)	✓	✓	✓
			2000K	95	428	1403	428	1403				
			2200K	106	477	1565	477	1565				
			2400K	109	491	1609	491	1609				
			2700K	122	549	1801	549	1801				
			3000K	129	581	1905	581	1905				
			3500K	132	594	1949	594	1949				
			4000K	132	594	1949	594	1949				
6000K	126	567	1860	567	1860							

RIBBONLYTE SPECIFICATIONS & COMPATIBILITY

Available Wattages	Cuttable Length	LED Pitch	Color Temp.	lm/W without Lens	Delivered Lumens with Round Milky Lens		Delivered Lumens with Square Milky Lens		Max Length	Compatible with Channel		
					lm/ft	lm/m	lm/ft	lm/m		IP20	IP65	IP68
3.0 Static White Double Row	0.7 in. (17.9 mm)	136 LEDs/ft (448 LEDs/m)	1800K	73	158	518	158	518	65 ft 7 in. (20 m)	✓	N/A	N/A
			2000K	86	186	612	186	612				
			2200K	94	204	668	204	668				
			2400K	97	209	686	209	686				
			2700K	109	236	774	236	774				
			3000K	118	255	836	255	836				
			3500K	119	257	843	257	843				
			4000K	118	255	836	255	836				
			6000K	114	247	811	247	811				
6.0 Static White Double Row	0.7 in. (17.9 mm)	136 LEDs/ft (448 LEDs/m)	1800K	73	316	1036	316	1036	39 ft (12 m)	✓	N/A	N/A
			2000K	86	373	1223	373	1223				
			2200K	94	407	1336	407	1336				
			2400K	97	418	1373	418	1373				
			2700K	109	472	1548	472	1548				
			3000K	118	510	1673	510	1673				
			3500K	119	514	1685	514	1685				
			4000K	118	510	1673	510	1673				
			6000K	114	495	1623	495	1623				
12.0 Static White Double Row	0.7 in. (17.9 mm)	136 LEDs/ft (448 LEDs/m)	1800K	69	599	1967	599	1967	26 ft 3 in. (8 m)	✓	N/A	N/A
			2000K	82	708	2322	708	2322				
			2200K	89	773	2535	773	2535				
			2400K	92	794	2606	794	2606				
			2700K	104	895	2938	895	2938				
			3000K	112	968	3175	968	3175				
			3500K	113	975	3199	975	3199				
			4000K	112	968	3175	968	3175				
			6000K	109	939	3080	939	3080				
0.75 Static Color Series 2	1.97 in. (50 mm)	48 LEDs/ft (160 LEDs/m)	Red	41	23	76	23	76	IP20: 49 ft (15 m) IP65/IP68: 32.8 ft (10 m)	✓	✓	✓
			Green	175	98	323	98	323				
			Blue	19	11	35	11	35				
			Amber	34	19	63	19	63				
1.5 Static Color Series 2	1.97 in. (50 mm)	48 LEDs/ft (160 LEDs/m)	Red	42	47	155	47	155	IP20: 49 ft (15 m) IP65/IP68: 32.8 ft (10 m)	✓	✓	✓
			Green	160	180	591	180	591				
			Blue	18	20	66	20	66				
			Amber	34	38	125	38	125				
2.2 Static Color Series 2	1.97 in. (50 mm)	48 LEDs/ft (160 LEDs/m)	Red	42	69	277	69	277	IP20: 42 ft (12.8 m) IP65/IP68: 32.8 ft (10 m)	✓	✓	✓
			Green	145	239	785	239	785				
			Blue	18	30	97	30	97				
			Amber	34	56	184	56	184				
3.0 Static Color Series 2	1.97 in. (50 mm)	48 LEDs/ft (160 LEDs/m)	Red	40	90	295	90	295	32.8 ft (10 m)	✓	✓	✓
			Green	127	286	937	286	937				
			Blue	25	56	185	56	185				
			Amber	29	65	214	65	214				
4.4 Static Color Series 2	1.97 in. (50 mm)	48 LEDs/ft (160 LEDs/m)	Red	38	125	411	125	411	29 ft (8.8 m)	✓	✓	✓
			Green	117	386	1267	386	1267				
			Blue	24	79	260	79	260				
			Amber	25	83	271	83	271				
5.0 Static Color Series 2	1.4 in. (35.7 mm)	68 LEDs/ft (224 LEDs/m)	Red	37	139	455	139	455	30 ft (9.14 m)	✓	✓	✓
			Green	116	435	1427	435	1427				
			Blue	24	90	295	90	295				
			Amber	26	98	320	98	320				
6.0 Static Color Series 2	1.4 in. (35.7 mm)	68 LEDs/ft (224 LEDs/m)	Red	37	167	546	167	546	28 ft (8.5 m)	✓	✓	✓
			Green	113	509	1668	509	1668				
			Blue	23	104	340	104	340				
			Amber	24	108	354	108	354				

RIBBONLYTE SPECIFICATIONS & COMPATIBILITY

Available Wattages	Cuttable Length	LED Pitch	Color Temp.	lm/W without Lens	Delivered Lumens with Round Milky Lens		Delivered Lumens with Square Milky Lens		Max Length	Compatible with Channel		
					lm/ft	lm/m	lm/ft	lm/m		IP20	IP65	IP68
2.4 Static White Linea	1.97 in. (50 mm)	146 LEDs/ft (480 LEDs/m)	2700K	67	120.8	396	120.8	396	21.3 ft (6.5 m)	✓	n/a	n/a
			3000K	71	127.5	419.3	127.5	419.3				
			3500K	83	149.3	490.5	149.3	490.5				
			4000K	83	149.3	490.5	149.3	490.5				
3.0 Static White Linea	1.97 in. (50 mm)	146 LEDs/ft (480 LEDs/m)	2700K	66	148.5	487.5	148.5	487.5	21.3 ft (6.5 m)	✓	n/a	n/a
			3000K	73	164.3	539.3	164.3	539.3				
			3500K	78	175.5	576	175.5	576				
			4000K	83	186.8	612.8	186.8	612.8				
4.3 Static White Linea	1.97 in. (50 mm)	146 LEDs/ft (480 LEDs/m)	2700K	75	242.3	793.5	242.3	793.5	24.6 ft (7.5 m)	✓	n/a	n/a
			3000K	78	251.3	825	251.3	825				
			3500K	86	277.5	910.5	277.5	910.5				
			4000K	86	277.5	910.5	277.5	910.5				
6.1 Variable White Linea	1.09 in. (27.78 mm)	175 LEDs/ft (576 LEDs/m)	2700K + 6500K	95	435	1427.3	435	1427.3	16.4 ft (5 m)	✓	n/a	n/a
1.0 Variable White Series 2	1.97 in. (50 mm)	42 LEDs/ft (140 LEDs/m)	2000K + 6500K	85	64	209	64	209	32.8 ft (10 m)	✓	✓	✓
3.0 Variable White Series 2	1.97 in. (50 mm)	42 LEDs/ft (140 LEDs/m)	2000K + 6500K	80	180	591	180	591	32.8 ft (10 m)	✓	✓	✓
6.0 Variable White Series 2	1.97 in. (50 mm)	42 LEDs/ft (140 LEDs/m)	2000K + 6500K	75	337.5	1107	337.5	1107	19 ft 8 in. (6 m)	✓	✓	✓
3.0 Variable White Double Row	1.97 in. (50 mm)	84 LEDs/ft (280 LEDs/m)	2000K + 6500K	87	188	617	188	617	65 ft 7 in. (20 m)	✓	n/a	n/a
6.0 Variable White Double Row	1.97 in. (50 mm)	84 LEDs/ft (280 LEDs/m)	2000K + 6500K	82	354	1162	354	1162	45 ft 11 in. (14 m)	✓	n/a	n/a
12.0 Variable White Double Row	1.97 in. (50 mm)	84 LEDs/ft (280 LEDs/m)	2000K + 6500K	71	613	2013	613	2013	22 ft 11 in. (7 m)	✓	n/a	n/a
1.5 Static White Xacta	0.2 in. (5 mm)	61 LEDs/ft (200 LEDs/m)	1800K	71	89.9	294.8	89.9	294.8	32.74 ft (9.98 m)	✓	n/a	n/a
			2000K	84	106.1	347.9	106.1	347.9				
			2200K	92	116.4	381.7	116.4	381.7				
			2400K	96	120.8	396.2	120.8	396.2				
			2700K	109	137.0	449.4	137.0	449.4				
			3000K	113	142.9	468.7	142.9	468.7				
			3500K	117	147.3	483.2	147.3	483.2				
			4000K	115	144.4	473.6	144.4	473.6				
3.0 Static White Xacta	0.2 in. (5 mm)	61 LEDs/ft (200 LEDs/m)	1800K	71	160.0	524.9	160.0	524.9	23.62 ft (7.2 m)	✓	n/a	n/a
			2000K	84	188.8	619.6	188.8	619.6				
			2200K	92	207.2	679.8	207.2	679.8				
			2400K	95	215.1	705.7	215.1	705.7				
			2700K	108	243.9	800.3	243.9	800.3				
			3000K	113	254.4	834.7	254.4	834.7				
			3500K	116	262.3	860.6	262.3	860.6				
			4000K	114	257.0	843.3	257.0	843.3				
4.5 Static White Xacta	0.2 in. (5 mm)	61 LEDs/ft (200 LEDs/m)	1800K	72	244.3	801.4	244.3	801.4	19.03 ft (5.8 m)	✓	n/a	n/a
			2000K	85	288.3	945.9	288.3	945.9				
			2200K	93	316.3	1037.8	316.3	1037.8				
			2400K	97	328.3	1077.2	328.3	1077.2				
			2700K	110	372.4	1221.7	372.4	1221.7				
			3000K	114	388.4	1274.3	388.4	1274.3				
			3500K	118	400.4	1313.7	400.4	1313.7				
			4000K	116	392.4	1287.4	392.4	1287.4				
6000K	113	384.4	1261.2	384.4	1261.2							





RIBBONLYTE SPECIFICATIONS & COMPATIBILITY

Available Wattages	Cuttable Length	LED Pitch	Color Temp.	lm/W without Lens	Delivered Lumens with Round Milky Lens		Delivered Lumens with Square Milky Lens		Max Length	Compatible with Channel		
					lm/ft	lm/m	lm/ft	lm/m		IP20	IP65	IP68
1.5 Variable White Xacta	0.2 in. (5 mm)	122 LEDs/ft (400 LEDs/m)	2400K + 6000K	138	154.1	505.7	154.1	505.7	32.15 ft (9.8 m)	✓	n/a	n/a
3.0 Variable White Xacta	0.2 in. (5 mm)	122 LEDs/ft (400 LEDs/m)	2400K + 6000K	136	302.6	992.7	302.6	992.7	22.31 ft (6.8 m)	✓	n/a	n/a
4.5 Variable White Xacta	0.2 in. (5 mm)	122 LEDs/ft (400 LEDs/m)	2400K + 6000K	134	427.4	1402	427.4	1402	19.03 ft (5.8 m)	✓	n/a	n/a
4.4 RGBW Series 2	1.97 in. (50 mm)	36 LEDs/ft (120 LEDs/m)	RGBW (All on)	45	138.6	454.7	138.6	454.7	19 ft 8 in. (6 m)	✓	n/a	n/a
5.5 RGBW Series 2	1.97 in. (50 mm)	36 LEDs/ft (120 LEDs/m)	RGBW (All on)	59	272.2	745.3	272.2	745.3	IP65: 16 ft 4 in. (5 m) IP68: 19 ft 7.9 in. (6 m)	n/a	✓	✓
8.8 RGBW Series 2	1.97 in. (50 mm)	36 LEDs/ft (120 LEDs/m)	RGBW (All on)	61	375.8	1232.9	375.8	1232.9	16 ft 4 in. (5 m)	✓	n/a	n/a
3.0 RGBW Double Row	1.3 in. (33 mm)	72 LEDs/ft (240 LEDs/m)	RGBW (All on)	91	205	672	205	672	26 ft 3 in. (8 m)	✓	n/a	n/a
3.0 RGBA Double Row	1.3 in. (33 mm)	72 LEDs/ft (240 LEDs/m)	RGBA (All on)	78	205	672	205	672	26 ft 3 in. (8 m)	✓	n/a	n/a
6.0 RGBW Double Row	1.3 in. (33 mm)	72 LEDs/ft (240 LEDs/m)	RGBW (All on)	91	410	1344	410	1344	22 ft 11 in. (7 m)	✓	n/a	n/a
6.0 RGBA Double Row	1.3 in. (33 mm)	72 LEDs/ft (240 LEDs/m)	RGBA (All on)	80	410	1344	410	1344	22 ft 11 in. (7 m)	✓	n/a	n/a
12.0 RGBW Double Row	1.3 in. (33 mm)	72 LEDs/ft (240 LEDs/m)	RGBW (All on)	79	711	2333	711	2333	14 ft 9 in. (4.5 m)	✓	n/a	n/a
12.0 RGBA Double Row	1.3 in. (33 mm)	72 LEDs/ft (240 LEDs/m)	RGBA (All on)	75	711	2333	711	2333	14 ft 9 in. (4.5 m)	✓	n/a	n/a
4.4 5-in-1 RGBWW	2.46 in. (62.5 mm)	29 LED/ft (96 LED/m)	RGBWW (All on)	59	181.7	596.2	181.7	596.2	16 ft 4 in (5 m)	✓	n/a	n/a
8.8 5-in-1 RGBWW	2.46 in. (62.5 mm)	29 LED/ft (96 LED/m)	RGBWW (All on)	50	308	1010.5	308	1010.5	11 ft 6 in (3.5 m)	✓	n/a	n/a
RGBW Addressable	3.94 in. (100 mm)	18 LEDs/ft (60 LEDs/m)	Red	33.5	25.1	82.5	25.1	82.5	16 ft 5.64 in. (5.02 m)	n/a	n/a	✓ IP67
			Green	82	61.5	201.8	61.5	201.8				
			Blue	15.5	11.6	38.1	11.6	38.1				
			White	103	77.3	253.5	77.3	253.5				
			All	40	181.6	595.8	181.6	595.8				
6.1 Pixel RGB	3.94 in. (100 mm)	18 LEDs/ft (60 LEDs/m)	RGB (All on)	21	93.38	306	93.38	306	24 ft 7.2 in. (7.5 m)	✓	n/a	n/a
5.2 Warm Dim	3.94 in. (100 mm)	36 LEDs/ft (120 LEDs/m)	WARM DIM	55	215	704	215	704	16 ft 4 in. (5 m)	✓	✓	✓

DIODE VISIBILITY CHART (Data below applies to installations with Milky lens only)

 No Visible Diode = N Note: Linea RibbonLyte has no visible diode				 With Visible Diode = Y						
Static White & Static Color Series 2	Static White & Variable White Xacta	4.4 RGBW Series 2	5.5 RGBW Series 2	8.8 RGBW Series 2	4.4 5-in-1 RGBWW	8.8 5-in-1 RGBWW	6.1 Pixel RGB	Warm Dim	Variable White Series 2	
0.75/1.5/2.2/3.0/4.4/5.0/6.0	1.5/3.0/4.5								1.0/3.0/6.0	
IP20/IP65/IP68	IP20	IP20	IP68	IP20	IP20	IP20	IP20	IP20/IP65/IP68	IP20/IP65/IP68	
N	N	N	N	N	N	N	N	N	N	

AVAILABLE DRIVERS / CONTROLLERS AND DIMMING OPTIONS / WIRE GAUGE CHART

0-10V/ELV/MLV 3-IN-1	ELV	0-10V VW/WD	COMPACT
			
<p>60W, 96W, 288W 0-10V/ELV/MLV 3-in-1 Dimmable Drivers</p> <p>Part No.:</p> <ul style="list-style-type: none"> • DRVW2460TRI010 (60 W) • DRVW2496TRI010 (96 W) • DRVW24288TRI010 (288 W) <p>24 VDC 120-277 VAC IP65, dry/damp/wet locations UL Listed</p>	<p>60W Dimmable Driver</p> <p>Part No.:</p> <ul style="list-style-type: none"> • DRVW2460ELV <p>24 VDC 100-130 VAC Fits in single-gang switch boxes IP20, dry locations UL Recognized</p>	<p>0-10V Dimmable 90W VW/WD Driver</p> <p>Part No.:</p> <ul style="list-style-type: none"> • DRVRFWDVW2490120 <p>24 VDC 100-277 VAC IP23, dry/damp locations UL Listed</p>	<p>60W, 96W Non-Dimming Compact Drivers</p> <p>Part No.:</p> <ul style="list-style-type: none"> • DRV2460C (60 W) • DRV2496C (96 W) <p>24 VDC 120-277 VAC IP20, dry locations UL Class P</p>

ATHENA WIRELESS COMPATIBLE	CASAMBI COMPATIBLE DRIVERS	DIMMABLE DALI-2 DRIVERS	DIMMABLE DALI-2 DRIVERS
			
<p>94W Athena Wireless Compatible Drivers</p> <p>Part No.:</p> <ul style="list-style-type: none"> • DRVW2494ATH1CH (1 channel) • DRVW2494ATH2CH (2 channel) <p>24 VDC 100-277 VAC Dry locations UL Listed</p>	<p>100W & 200W Casambi Compatible 4 Channel Drivers</p> <p>Part No.:</p> <ul style="list-style-type: none"> • DRVW24100CAS4CH (100 W) • DRVW24200CAS4CH (200 W) <p>24 VDC 100-277 VAC IP66, dry/damp/wet locations UL Listed, CE, RoHS, Bluetooth, CASAMBI</p>	<p>96W DIMMABLE DALI-2 DT6 D4I & DALI-2 DT8 D4I DRIVERS</p> <p>Part No.:</p> <ul style="list-style-type: none"> • DRVW2496DALI1CH (1 channel) • DRVW2496DALI2CH (2 channel) <p>24-26 VDC 120-277 VAC IP67, dry/damp/wet locations UL Listed</p>	<p>75W, 150W, 240W DALI-2 Dimmable Drivers</p> <p>Part No.:</p> <ul style="list-style-type: none"> • DRVW2475DALI1CH (75 W, 1 channel) • DRVW24150DALI1CH (150 W, 1 channel) • DRVW24240DALI1CH (240 W, 1 channel) • DRV24150DALI2CH (150 W, 2 channels) • DRV24150DALI4CH (150 W, 4 channels) <p>24 VDC 120-277 VAC IP67, damp/wet locations (1-channel drivers only) IP20, dry location (2-channel & 4-channel drivers only) CE, RoHS, SELV</p>

DMX CONTROLLERS, VARIABLE WHITE DIMMER, WARM DIM DIMMER - FOR COLOR CHANGING FIXTURES

				
<p>GLASS TOUCH WALL CONTROLLERS</p> <p>Part No.:</p> <ul style="list-style-type: none"> • AWCRGBWBK • AWCVWBK 	<p>1 ZONE WALL CONTROLLER</p> <p>Part No.: DMXCTRLG</p>	<p>5 ZONE WALL CONTROLLER</p> <p>Part No.: DMXCTRL</p>	<p>10 ZONE WALL CONTROLLER</p> <p>Part No.: DMXCTRLD</p>	<p>6 UNIVERSE DMX CONTROLLER</p> <p>Part No.: DMXCTRLDR6U</p>
				
<p>VARIABLE WHITE DIMMER</p> <p>Part No.:</p> <ul style="list-style-type: none"> • RFDIMVWWH (White) • RFDIMVWBK (Black) 	<p>WARM DIM DIMMER</p> <p>Part No.:</p> <ul style="list-style-type: none"> • RFDIMWDWH (White) • RFDIMWDBK (Black) 	<p>4 CHANNEL WATERPROOF DMX INTERFACE</p> <p>Part No.: DMXINFWLC4D</p>	<p>5 CHANNEL DMX DECODER</p> <p>Part No.: DMXINF5</p>	<p>DMX OPTO SPLITTER</p> <p>Part No.: DMXOS8</p>

Wattages	30		60		96		150		200		240		300		320	
	Feet	Meters	Feet	Meters	Feet	Meters	Feet	Meters	Feet	Meters	Feet	Meters	Feet	Meters	Feet	Meters
24 AWG / 0.25 mm ²	14	4.27	9	2.74	5.5	1.68	3.75	1.14	2.75	0.84	2.25	0.69	1.75	0.53	1.75	0.53
22 AWG / 0.34 mm ²	22	6.71	14	4.27	9	2.74	5.75	1.75	4.5	1.37	3.5	1.07	2.75	0.84	2.75	0.84
20 AWG / 0.5 mm ²	35	10.67	23	7.01	14	4.27	9	2.74	7	2.13	5.75	1.75	4.5	1.37	4.25	1.30
18 AWG / 0.75 mm ²	56	17.07	37	11.28	23	7.01	15	4.57	11	3.35	9	2.74	7.5	2.29	7	2.13
16 AWG / 1.5 mm ²	90	27.44	60	18.29	37	11.28	24	7.32	18	5.49	15	4.57	12	3.66	11	3.35
14 AWG / 2.5 mm ²	142	43.29	95	28.96	59	17.99	38	11.59	28	8.54	23	7.01	19	5.79	17	5.18
12 AWG / 4 mm ²	226	68.90	151	46.04	94	28.66	60	18.29	45	13.72	37	11.28	30	9.15	28	8.54
10 AWG / 6 mm ²	360	109.76	240	73.17	150	45.73	96	29.27	72	21.95	60	18.29	48	14.63	45	13.72
8 AWG / 10 mm ²	574	175.00	381	116.16	239	72.87	153	46.65	115	35.06	95	28.96	76	23.17	71	21.65

WIRING DIAGRAMS - STATIC WHITE / STATIC COLOR / RGBW / RGBA / RGBWW

0-10 V

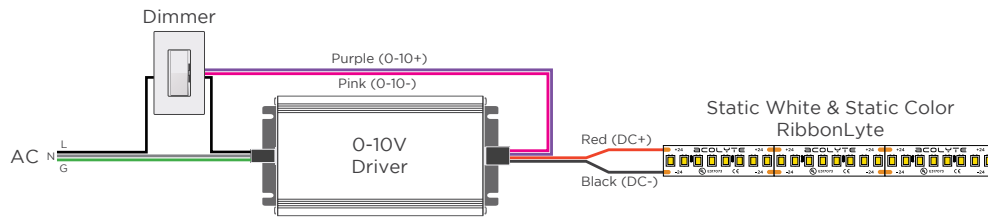

MLV / ELV

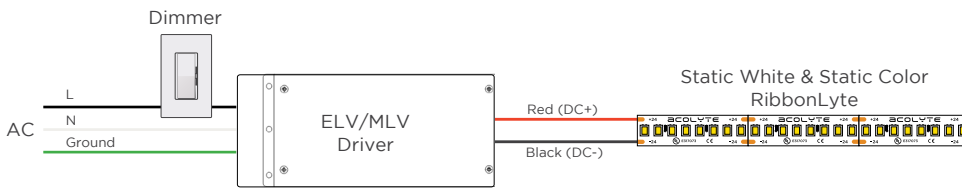

DMX WIRING WITH STATIC WHITE & STATIC COLOR RIBBONLYTE

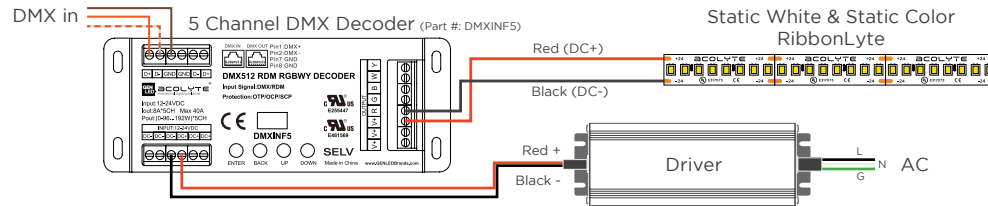

DALI-2 WIRING WITH STATIC WHITE & STATIC COLOR RIBBONLYTE

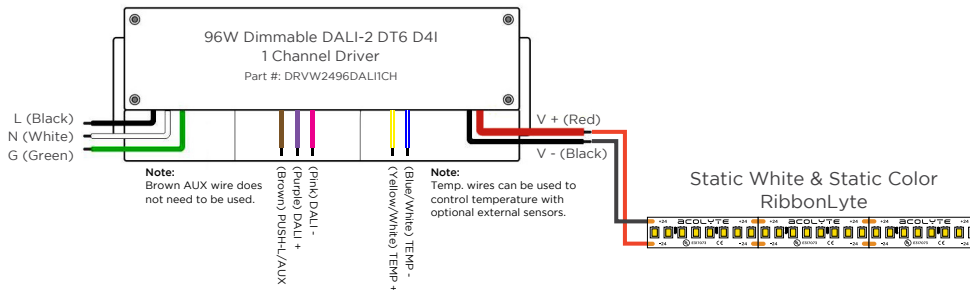

STATIC WHITE & STATIC COLOR RIBBONLYTE WIRING WITH ATHENA WIRELESS COMPATIBLE DRIVER

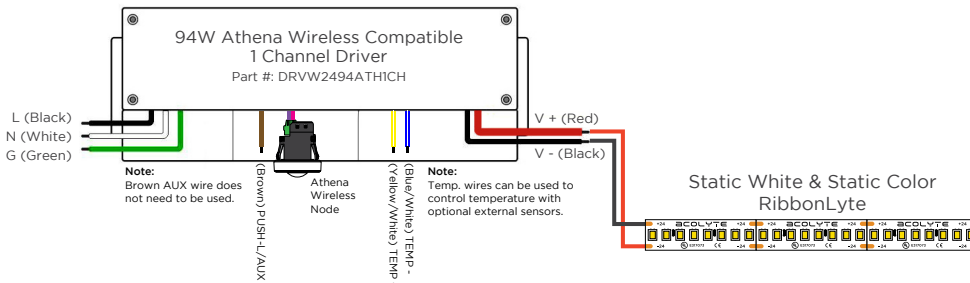

DMX WITH RGBWW 5-IN-1 RIBBONLYTE

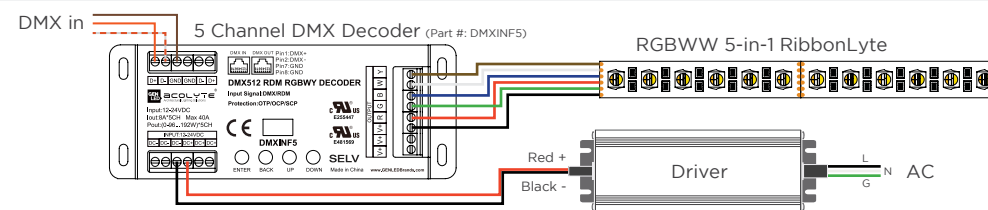

WIRE COLORS PER RIBBONLYTE COLOR

STATIC WHITE + STATIC COLOR

Red Wire (+) Positive
Black Wire (-) Negative

RGBW + RGBA

Black Wire (+) Positive
Green Wire (-) goes to Green Channel
Red Wire (-) goes to Red Channel
Blue Wire (-) goes to Blue Channel
White Wire (-) goes to White Channel

RGBWW

Black (+) Positive
Green Wire (-) goes to Green Channel
Red Wire (-) goes to Red Channel
Blue Wire (-) goes to Blue Channel
White Wire (-) goes to White Channel 1
Brown Wire (-) goes to White Channel 2

WIRING DIAGRAMS - VARIABLE WHITE

2-CHANNEL VARIABLE WHITE DIMMING

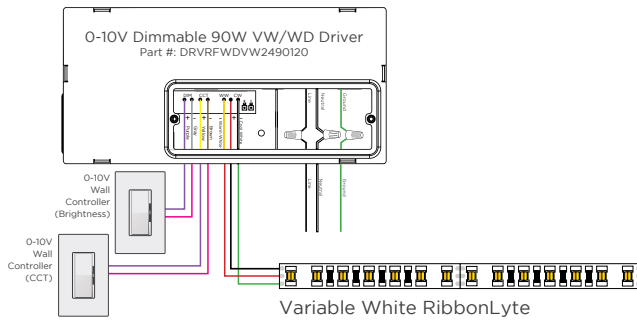

WIRE COLORS PER RIBBONLYTE COLOR

VARIABLE WHITE
Black Wire (+) Positive
Red Wire (-) goes to Warm White Channel
Green Wire (-) goes to Cool White Channel

DMX WIRING WITH VARIABLE WHITE RIBBONLYTE

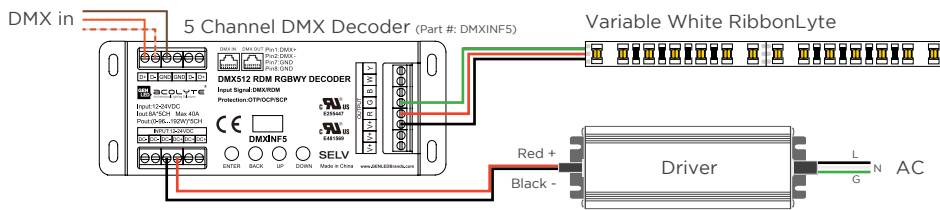

DALI-2 WIRING WITH VARIABLE WHITE RIBBONLYTE

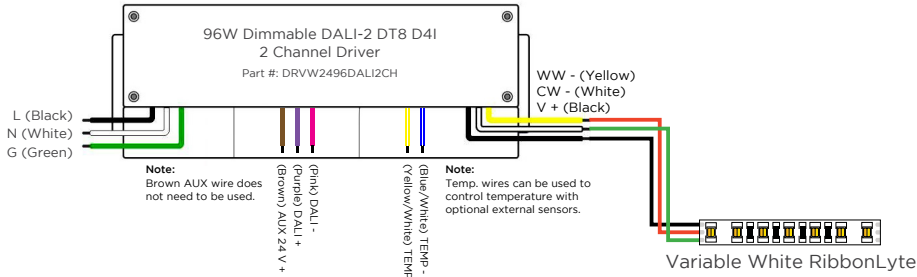

VARIABLE WHITE RIBBONLYTE WIRING WITH ATHENA WIRELESS COMPATIBLE DRIVER

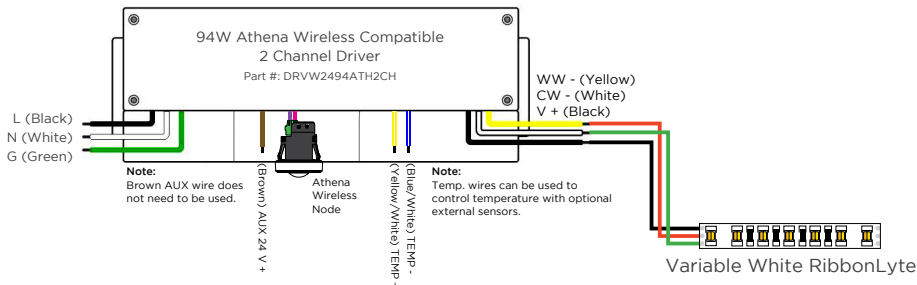

WIRING DIAGRAMS WITH RGBW ADDRESSABLE RIBBONLYTE

One DMX Universe consists of 128 addresses and 512 channels (42 ft / 12.8 m of RibbonLyte).

Any single run of RibbonLyte that is less than 16 ft, 4 in. can be wired directly to the controller.

For additional runs, Opto Splitter must be used. Each individual run will need its own Opto Splitter output.

WIRE INDEX	
+	(24V +)
PI	(DMX GND)
A+	(DMX +)
B-	(DMX -)
GND	(24V -)

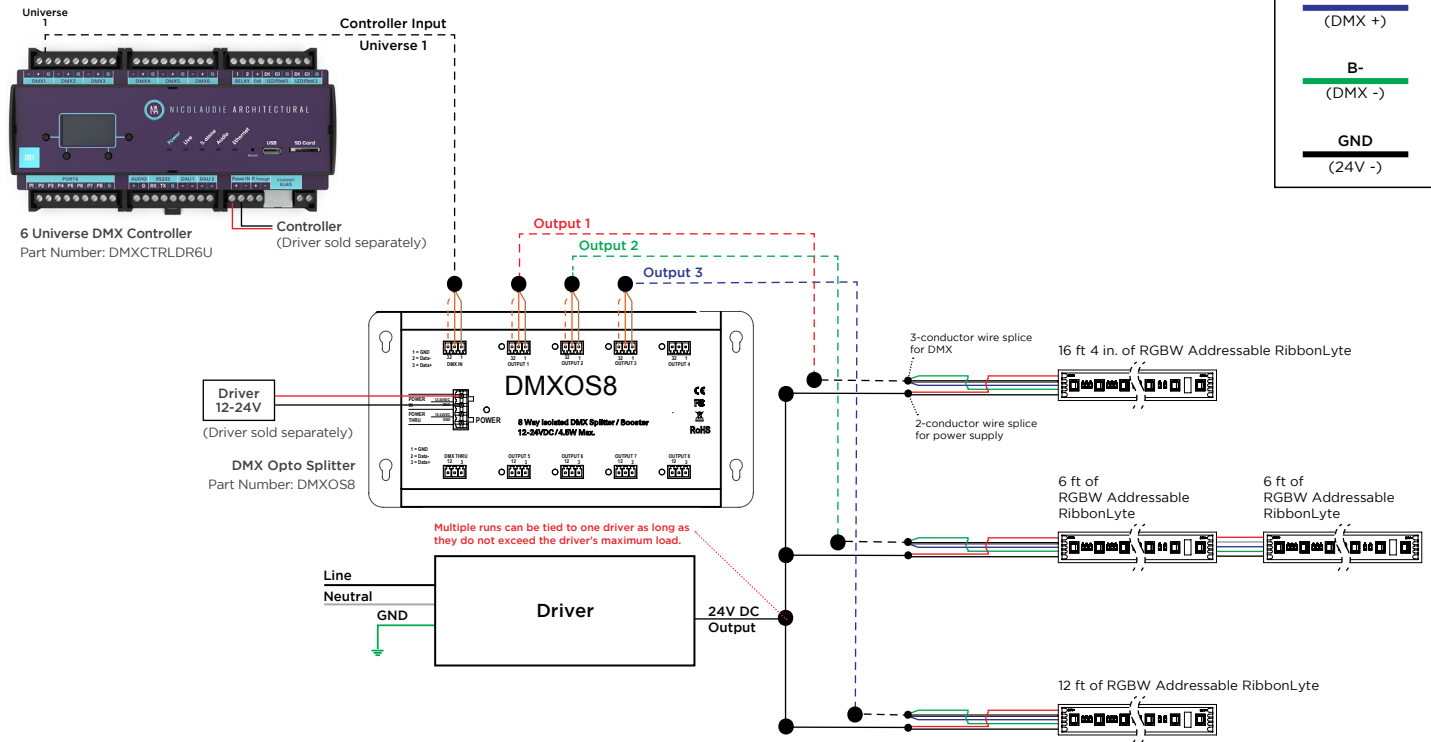

REV.25JUN2026

GLOBAL HQ

320 Murray Hill Pkwy
East Rutherford, NJ 07073
U.S.
T: (+1) 212 629 6830
E: Sales-US@GENLEDBrands.com

EUROPEAN HQ

Hogeweyselaan 119
1382 JK Weesp
Netherlands
T: (+31) 346 235 000
E: SalesEurope@GENLEDBrands.com

MEINA HQ

PO Box 371378, #823, Building 4EA
Dubai Airport Free Zone
Dubai, UAE
T: (+971) 4 701 7901
E: SalesMEINA@genledbrands.com

ASIA-PACIFIC HQ

Room 402, Building D
Shenshi Tongchuang Science and Technology Park
No. 16 Hongyin Road
Xingqiang Community, Xihu Street
Guangming District, Shenzhen, China 518107
T: (+86) 755 8529 0710
E: Sales-Pacific@GENLEDBrands.com