

AS20G CHANNEL FIXTURE

The AS20G Channel Fixture is a grazer channel with a 20° beam angle. (Adjust to wider beam angles by installing a profile assistant that moves the LEDs.) A grazer lens installed with mounting clips or tiltable stands can create a full range of light output and design options. Design a custom grazer fixture with AS20G Channel and our RibbonLyte products.

- Available for field or factory assembly
- Special optic lens focuses light
- Beam angle: 20°
- Adjust to 40°, 60°, 75° or 90° with profile assistant
- Wattage range: 0.75 W/ft (2.46 W/m) to 6.0 W/ft (19.7W/m)
- Static White delivered lumen range: 42.8 lm/ft (140.5 lm/m) - 538.6 lm/ft (1766.5 lm/m)

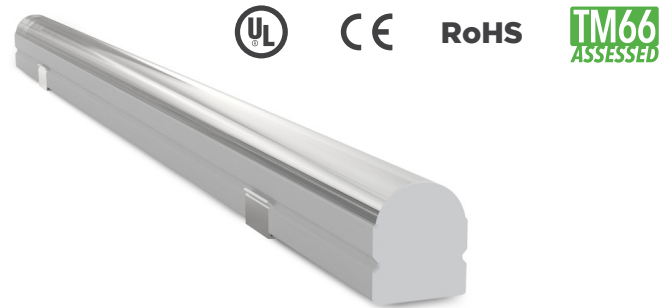

HOUSING FINISHES



*Additional fee applies

AVAILABLE LENS FINISHES



AVAILABLE COLORS & COLOR TEMPERATURES

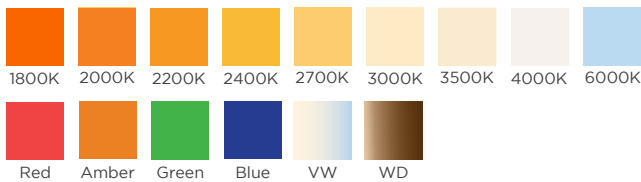

AVAILABLE BEAM ANGLES

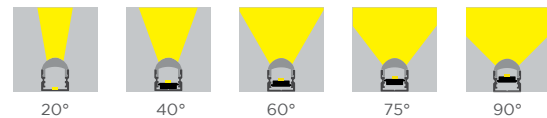

DIMENSIONS

AS20G Channel

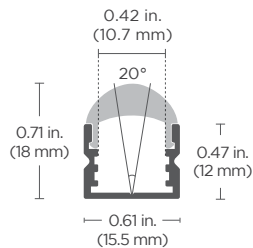

Width: 0.61 in. (15.5 mm)
Height: 0.71 in. (18 mm)
Internal Width: 0.42 in. (10.7 mm)

Mounting Clip (Included Accessory)

Side View

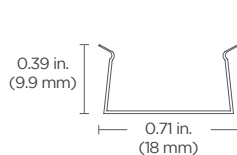

Width: 0.6 in. (15.2 mm)
Length: 0.71 in. (18 mm)
Height: 0.39 in. (9.9 mm)

Top View

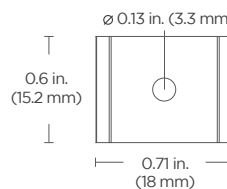

Assembled View

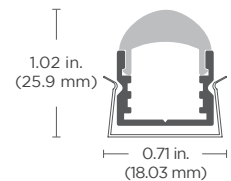

Note:

1. Each section of channel includes **3 mounting clips**.
2. **Magnetic mounting** option available (see page 2)
3. **Exterior channel applications** should be securely attached to the mounting surface with appropriate screws and/or liquid nails. Acolyte strongly recommends field assembly for exterior applications. Use mounting clips for interior applications only.

SPECIFICATIONS

Beam Angle	20° (40°, 60°, 75° or 90° with profile assistant)
Lens Type	Grazer Lens
Length	Channel is sold by the foot and cut to your exact desired length. Required amount of mounting clips included.
Operating Voltage	24V
Dimming	MLV / 0-10 Volt / ELV / DALI / DMX
Operating Temperature	-40° F to 158° F (-40° C to 70° C)
Colors	1800K, 2000K, 2200K, 2400K, 2700K, 3000K, 3500K, 4000K, 6000K, Red, Amber, Green, Blue, VW, Warm Dim (1800K, 2000K, 2200K only available in IP20)
CRI	90+ CRI (Static white only)
Lamp Life	L70 at 50,000 Hours
MacAdam Ellipses (SDCM)	2-Step Binning (For Static White LEDs only)
Certifications	UL Listed UL 2108 Issued: 2004/02/27 Ed: 1 Rev: 2014/02/24 Low Voltage Lighting Systems CSA C22.2#9.0 Issued: 1996/06/01 Ed: 1 (R2011) General Requirements for Luminaires; with Gen. Inst. 1: 1997, Gen Inst. 2: 1998. ROHS compliant

ACCESSORIES

Profile Assistant (Part # CHAS20GLEDMNT)

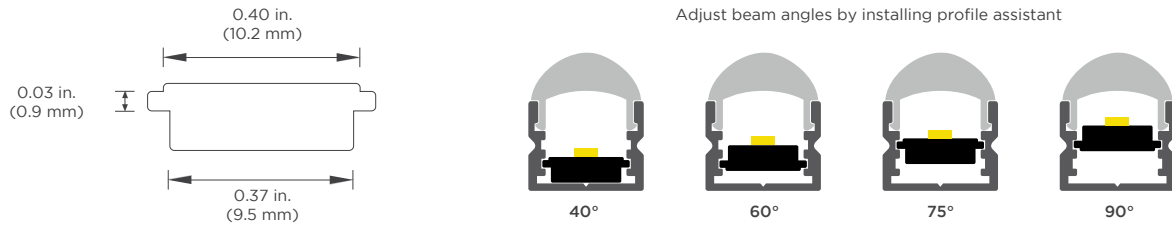

Tilttable Stand (Part # TILTSTANDST)

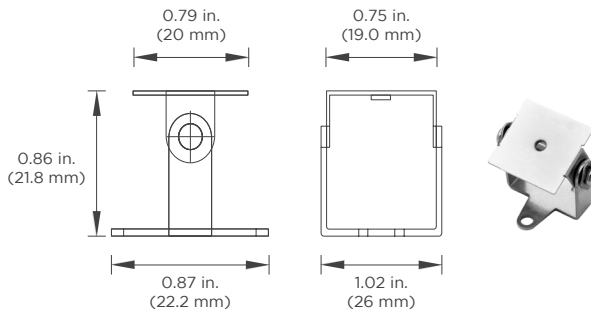

Magnetic Mount (Part #: CHMAGO.5)

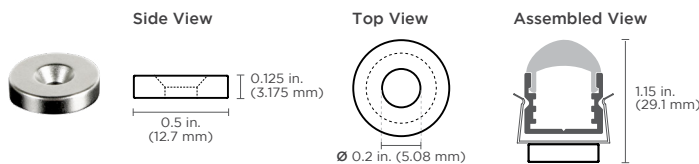

Features:

- High-energy neodymium magnets come attached to mounting clips with countersink hex nuts
- Create easy-mount magnetic channels with minimal surface gaps; no tools or drilling necessary
- Magnets rated for 8 lbs. of pull force with static load

Applications:

- Industrial lighting retrofits for troffers and other metal fixtures
- Metal retail shelf lighting
- Temporary light fixture installations

Acolyte does not warrant or represent that the information is free from errors or omission. The information may change without notice and Acolyte is not in any way liable for the accuracy of any information printed and stored or in any way interpreted or used.

STEP 1 Complete Channel Part Number

CHANNEL	LENS	HOUSING COLOR	
CHAS20G	G		
CHAS20G - AS20G Channel	G - Grazer Lens	SV - Silver (default)	WH - White
		BK - Black	
		Consult factory for custom colors	

STEP 2 Complete RibbonLyte Part Number

CATEGORY	CRI	RIBBON TYPE & IP RATING	
RB			
RB - RibbonLyte	0 - Static Color, Color Changing 90 - 90+ CRI Static White	LINEA20 - Linea RibbonLyte IP20 SWS220 - Static White Series 2 IP20 SWS265 - Static White Series 2 IP65 SCS220 - Static Color Series 2 IP20 SCS265 - Static Color Series 2 IP65	VWS220 - VW Series 2 IP20 VWS265 - VW Series 2 IP65 WD20 - Warm Dim IP20 WD65 - Warm Dim IP65

NOTE: To ensure waterproofing standards are met, IP65 can NOT be cut in the field.

WATTAGE

- 0.75 - 0.75 W/ft (2.46 W/m - Static White, Static Color)
- 1.0 - 1.0 W/ft (3.3 W/m - Variable White)
- 1.5 - 1.5 W/ft (4.9 W/m - Static White, Static Color)
- 2.2 - 2.2 W/ft (7.2 W/m - Static White, Static Color)
- 2.4 - 2.4 W/ft (8 W/m - Static White)
- 3.0 - 3.0 W/ft (9.8 W/m - Static White, Static Color, Variable White)
- 4.3 - 4.3 W/ft (14 W/m - Static White)
- 4.4 - 4.4 W/ft (14.4 W/m - Static White, Static Color)
- 5.0 - 5.0 W/ft (16.4 W/m - Static White, Static Color)
- 5.2 - 5.2 W/ft (17.1 W/m - Warm Dim)
- 6.0 - 6.0 W/ft (19.7 W/m - Static White, Static Color, Variable White)
- 6.1 - 6.1 W/ft (20 W/m - Variable White)

COLOR

- 18 - 1800K R - Red
- 20 - 2000K A - Amber
- 22 - 2200K G - Green
- 24 - 2400K B - Blue
- 27 - 2700K VW - Variable White
- 30 - 3000K 2920 - Warm Dim 2900K - 2000K (IP20)
- 35 - 3500K 2721 - Warm Dim 2700K - 2100K (IP65+IP68)
- 40 - 4000K Z - Undecided**
- 60 - 6000K ** For quotes only. Must be chosen before final order.

CONNECTION OPTIONS (See diagrams on the right)

- 1 - End Feed Bare Wire Connection
- 2 - Back Feed Bare Wire Connection
- 3 - Side Feed Bare Wire Connection
- 4 - End Feed with IP67 Male Coupler
- 5 - Soldered Daisy Chain
- 6 - Daisy Chain With IP67 Couplers

Custom Length (ft.)

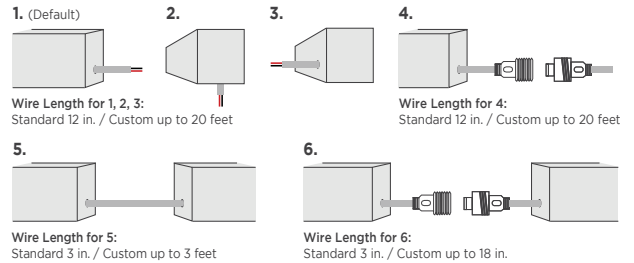

STEP 3 Complete Assembly Option & Length

ASSEMBLY OPTION **LENGTH** (Standard factory assembled length up to 6 ft 6.7 in. / 2 m)

- FI - Field Assembly
- FA - Factory Assembly* (not recommended for exterior applications)

* Factory assembled runs exceeding 6 ft 6.7 in. (2 m) will be split into multiple daisy chained fixtures.

DO NOT BUTT END CAPS AGAINST EACH OTHER WHEN CREATING LONGER FIXTURES

Acolyte STRONGLY SUGGESTS field assembly (without using interior end caps) for direct-view fixtures of more than 6 ft 6.7 in. (2 m) in length. Field assembly without interior end caps will eliminate gaps or dead spots that can be caused by butting interior end caps against each other.

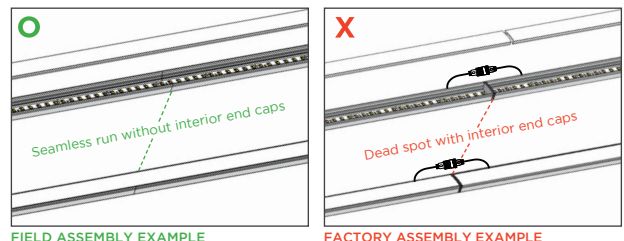

STEP 4 Add Accessories

ACCESSORIES

- TILTSTANDST - Tilttable Stand
- CHMAG0.5 - Magnetic Mount
- CHAS20GLEDMNT - Profile Assistant

RIBBONLYTE SPECIFICATIONS & COMPATIBILITY

Available Wattages	Cutttable Length	LED Pitch	Color Temp.	lm/W without Lens	Delivered Lumens with Grazer Lens	Max Length	Compatible with Channel		
							IP20	IP65	IP68
0.75 Static White Series 2	1.97 in. (50 mm)	48 LEDs/ft (160 LEDs/m)	1800K	84	42.8 lm/ft (140.5 lm/m)	IP20: 49 ft (15 m) IP65: 32.8 ft (10 m)	✓	✓	
			2000K	99	50.5 lm/ft (165.6 lm/m)				
			2200K	109	55.6 lm/ft (182.3 lm/m)				
			2400K	113	57.6 lm/ft (189 lm/m)				
			2700K	123	62.7 lm/ft (205.8 lm/m)				
			3000K	123	62.7 lm/ft (205.8 lm/m)				
			3500K	130	66.3 lm/ft (217.5 lm/m)				
			4000K	134	68.3 lm/ft (224.2 lm/m)				
			6000K	131	66.8 lm/ft (219.1 lm/m)				
1.5 Static White Series 2	1.97 in. (50 mm)	48 LEDs/ft (160 LEDs/m)	1800K	84	85.7 lm/ft (281 lm/m)	IP20: 49 ft (15 m) IP65: 32.8 ft (10 m)	✓	✓	
			2000K	98	100 lm/ft (327.9 lm/m)				
			2200K	109	111.2 lm/ft (364.7 lm/m)				
			2400K	113	115.3 lm/ft (378.1 lm/m)				
			2700K	123	125.5 lm/ft (411.5 lm/m)				
			3000K	123	125.5 lm/ft (411.5 lm/m)				
			3500K	129	131.6 lm/ft (431.6 lm/m)				
			4000K	134	136.7 lm/ft (448.3 lm/m)				
			6000K	131	133.6 lm/ft (438.3 lm/m)				
2.2 Static White Series 2	1.97 in. (50 mm)	48 LEDs/ft (160 LEDs/m)	1800K	83	124.2 lm/ft (407.3 lm/m)	IP20: 42 ft (12.8 m) IP65: 32.8 ft (10 m)	✓	✓	
			2000K	96	143.6 lm/ft (471.1 lm/m)				
			2200K	106	158.6 lm/ft (520.1 lm/m)				
			2400K	111	166.1 lm/ft (544.7 lm/m)				
			2700K	120	179.5 lm/ft (588.8 lm/m)				
			3000K	122	182.5 lm/ft (598.6 lm/m)				
			3500K	127	190 lm/ft (623.2 lm/m)				
			4000K	133	199 lm/ft (652.6 lm/m)				
			6000K	128	191.5 lm/ft (628.1 lm/m)				
3.0 Static White Series 2	1.97 in. (50 mm)	48 LEDs/ft (160 LEDs/m)	2400K	110	224.4 lm/ft (736 lm/m)	32.8 ft (10 m)	✓	✓	
			2700K	123	250.9 lm/ft (823 lm/m)				
			3000K	130	265.2 lm/ft (870 lm/m)				
			3500K	133	271.3 lm/ft (890 lm/m)				
			4000K	133	271.3 lm/ft (890 lm/m)				
			6000K	127	259.1 lm/ft (849.8 lm/m)				
4.4 Static White Series 2	1.97 in. (50 mm)	48 LEDs/ft (160 LEDs/m)	2400K	109	326.1 lm/ft (1069.7 lm/m)	29 ft (8.8 m)	✓	✓	
			2700K	122	365 lm/ft (1197.3 lm/m)				
			3000K	129	386 lm/ft (1266 lm/m)				
			3500K	132	394.9 lm/ft (1295.4 lm/m)				
			4000K	132	394.9 lm/ft (1295.4 lm/m)				
			6000K	126	377 lm/ft (1236.5 lm/m)				
5.0 Static White Series 2	1.4 in. (35.7 mm)	68 LEDs/ft (224 LEDs/m)	2400K	110	374 lm/ft (1226.7 lm/m)	30 ft (9.14 m)	✓	✓	
			2700K	123	418.2 lm/ft (1371.7 lm/m)				
			3000K	130	442 lm/ft (1449.8 lm/m)				
			3500K	133	452.2 lm/ft (1483.2 lm/m)				
			4000K	133	452.2 lm/ft (1483.2 lm/m)				
			6000K	127	431.8 lm/ft (1416.3 lm/m)				
6.0 Static White Series 2	1.4 in. (35.7 mm)	68 LEDs/ft (224 LEDs/m)	2400K	109	444.7 lm/ft (1458.7 lm/m)	28 ft (8.5 m)	✓	✓	
			2700K	122	497.8 lm/ft (1632.7 lm/m)				
			3000K	129	526.3 lm/ft (1726.3 lm/m)				
			3500K	132	538.6 lm/ft (1766.5 lm/m)				
			4000K	132	538.6 lm/ft (1766.5 lm/m)				
			6000K	126	514.1 lm/ft (1686.2 lm/m)				

RIBBONLYTE SPECIFICATIONS & COMPATIBILITY

Available Wattages	Cutttable Length	LED Pitch	Color Temp.	lm/W without Lens	Delivered Lumens with Grazer Lens	Max Length	Compatible with Channel		
							IP20	IP65	IP68
0.75 Static Color Series 2	1.97 in. (50 mm)	48 LEDs/ft (160 LEDs/m)	Red	41	26 lm/ft (86 lm/m)	IP20: 49 ft (15 m) IP65: 32.8 ft (10 m)	✓	✓	
			Green	175	112 lm/ft (366 lm/m)				
			Blue	19	12 lm/ft (40 lm/m)				
			Amber	34	22 lm/ft (71 lm/m)				
1.5 Static Color Series 2	1.97 in. (50 mm)	48 LEDs/ft (160 LEDs/m)	Red	42	54 lm/ft (176 lm/m)	IP20: 49 ft (15 m) IP65: 32.8 ft (10 m)	✓	✓	
			Green	160	204 lm/ft (669 lm/m)				
			Blue	18	23 lm/ft (75 lm/m)				
			Amber	34	43 lm/ft (142 lm/m)				
2.2 Static Color Series 2	1.97 in. (50 mm)	48 LEDs/ft (160 LEDs/m)	Red	42	79 lm/ft (258 lm/m)	IP20: 42 ft (12.8 m) IP65: 32.8 ft (10 m)	✓	✓	
			Green	145	271 lm/ft (889 lm/m)				
			Blue	18	34 lm/ft (110 lm/m)				
			Amber	33	62 lm/ft (202 lm/m)				
3.0 Static Color Series 2	1.97 in. (50 mm)	48 LEDs/ft (160 LEDs/m)	Red	40	81.6 lm/ft (267.6 lm/m)	IP20: 36 ft (11 m) IP65: 32.8 ft (10 m)	✓	✓	
			Green	127	259.1 lm/ft (849.8 lm/m)				
			Blue	25	51 lm/ft (167.3 lm/m)				
			Amber	29	59.2 lm/ft (194 lm/m)				
4.4 Static Color Series 2	1.97 in. (50 mm)	48 LEDs/ft (160 LEDs/m)	Red	38	113.7 lm/ft (372.9 lm/m)	28 ft 4 in. (8.64 m)	✓	✓	
			Green	117	350.1 lm/ft (1148.2 lm/m)				
			Blue	24	71.8 lm/ft (235.5 lm/m)				
			Amber	25	74.8 lm/ft (245.3 lm/m)				
5.0 Static Color Series 2	1.4 in. (35.7 mm)	68 LEDs/ft (224 LEDs/m)	Red	37	125.8 lm/ft (412.6 lm/m)	IP20: 33 ft 4 in. (10.1 m) IP65: 32.8 ft (10 m)	✓	✓	
			Green	116	394.4 lm/ft (1293.6 lm/m)				
			Blue	24	81.6 lm/ft (267.6 lm/m)				
			Amber	26	88.4 lm/ft (290 lm/m)				
6.0 Static Color Series 2	1.4 in. (35.7 mm)	68 LEDs/ft (224 LEDs/m)	Red	37	151 lm/ft (495.1 lm/m)	28 ft (8.5 m)	✓	✓	
			Green	113	461 lm/ft (1512.2 lm/m)				
			Blue	23	93.8 lm/ft (307.8 lm/m)				
			Amber	24	97.9 lm/ft (321.2 lm/m)				
2.4 Static White Linea	1.97 in. (50 mm)	146 LEDs/ft (480 LEDs/m)	2700K	67	144.9 lm/ft (475.2 lm/m)	21.3 ft (6.5 m)	✓	N/A	N/A
			3000K	71	153 lm/ft (503.1 lm/m)				
			3500K	83	179.1 lm/ft (588.6 lm/m)				
			4000K	83	179.1 lm/ft (588.6 lm/m)				
3.0 Static White Linea	1.97 in. (50 mm)	146 LEDs/ft (480 LEDs/m)	2700K	66	178.2 lm/ft (585 lm/m)	21.3 ft (6.5 m)	✓	N/A	N/A
			3000K	73	197.1 lm/ft (647.1 lm/m)				
			3500K	78	210.6 lm/ft (691.2 lm/m)				
			4000K	83	224.1 lm/ft (735.3 lm/m)				
4.3 Static White Linea	1.97 in. (50 mm)	146 LEDs/ft (480 LEDs/m)	2700K	75	290.7 lm/ft (952.2 lm/m)	24.6 ft (7.5 m)	✓	N/A	N/A
			3000K	78	301.5 lm/ft (990 lm/m)				
			3500K	86	333 lm/ft (1092.6 lm/m)				
			4000K	86	333 lm/ft (1092.6 lm/m)				
6.1 Variable White Linea	1.09 in. (27.78 mm)	175 LEDs/ft (576 LEDs/m)	2700K + 6500K	95	522 lm/ft (1712.7 lm/m)	16.4 ft (5 m)	✓	N/A	N/A
1.0 Variable White Series 2	1.97 in. (50 mm)	42 LEDs/ft (140 LEDs/m)	2000K + 6500K	85	57.8 lm/ft (189.6 lm/m)	32.8 ft (10 m)	✓	✓	
3.0 Variable White Series 2	1.97 in. (50 mm)	42 LEDs/ft (140 LEDs/m)	2000K + 6500K	80	163.2 lm/ft (535.3 lm/m)	32.8 ft (10 m)	✓	✓	
6.0 Variable White Series 2	1.97 in. (50 mm)	42 LEDs/ft (140 LEDs/m)	2000K + 6500K	75	306 lm/ft (1003.7 lm/m)	19 ft 8 in. (6 m)	✓	✓	
5.2 Warm Dim	3.94 in. (100 mm)	36 LEDs/ft (120 LEDs/m)	WARM DIM	55	194.5 lm/ft (637.9 lm/m)	16 ft 4 in. (5 m)	✓	✓	

AVAILABLE DRIVERS / CONTROLLERS AND DIMMING OPTIONS / WIRE GAUGE CHART

NON-DIMMING ELECTRONIC DRIVERS

ELV & MLV DRIVERS



30W, 60W, 96W Non-Dimming Electronic Class 2 Drivers

Part No.:
 • DRVW2430 (30 Watt)
 • DRVW2460 (60 Watt)
 • DRVW2496 (96 Watt)
 Output Voltage: 24 V
 Voltage Range: 120-277 VAC
 IP Rating: Dry or Damp
 UL Listed



240W, 320W Non-Dimming Electronic Drivers

Part No.:
 • DRVW24240 (240 Watt)
 • DRVW24320 (320 Watt)
 Output Voltage: 24 V
 Voltage Range: 90-305 VAC
 IP Rating: Dry or Damp
 UL Recognized



60W, 96W, 150W, 300W, 600w_test ELV/MLV Dimmable Drivers

Part No.:
 • DRVW2460ELVMLV (60 Watt)
 • DRVW2496ELVMLV (96 Watt)
 • DRVW24150ELVMLV (150 Watt)
 • DRVW24300ELVMLV (300 Watt)
 Line Voltage Dimmable Drivers
 Output Voltage: 24 V
 Voltage Range: 100-277 VAC
 IP Rating: IP67
 UL, CE, and CSA Listed

0-10V DRIVERS



0-10V Dimmable Waterproof Drivers

96W Part No.: DRVW249610P
288W Part No.: DRVW2428810P
 Output Voltage: 24 V (+/- 0.5V)
 Voltage Range: 100-277 VAC
 Environmental Rating: UL Wet Location
 UL Listed



0-10V Dimmable 90W VW/WD Driver

Part No.: DRVRFWDVW2490120

DMX CONTROLLER AND PART NUMBER - FOR COLOR CHANGING VERSIONS



GLASS TOUCH WALL CONTROLLERS
 Part Number: AWCRGBWBK
 AWCVWBK



1 ZONE WALL CONTROLLER
 Part Number: DMXCTRLG



5 ZONE WALL CONTROLLER
 Part Number: DMXCTRL



10 ZONE WALL CONTROLLER
 Part Number: DMXCTRLD

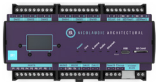

2 UNIVERSE DMX CONTROLLER
 Part Number: DMXCTRLDR2U



4 CHANNEL WATERPROOF DMX INTERFACE
 Part Number: DMXINFWLCD4



5 CHANNEL DMX INTERFACE
 Part Number: DMXINFOLED5



DMX OPTO SPLITTER
 Part Number: DMXOS8

6 UNIVERSE DMX CONTROLLER
 Part Number: DMXCTRLDR6U

DRIVER AND RIBBONLYTE AT FULL LOAD

Wattages	30		60		96		150		200		240		300		320		
	Wire Gauge	Feet	Meters	Feet	Meters	Feet	Meters	Feet	Meters	Feet	Meters	Feet	Meters	Feet	Meters	Feet	Meters
24 AWG / 0.25 mm ²	14	4.27	9	2.74	5.5	1.68	3.75	1.14	2.75	0.84	2.25	0.69	1.75	0.53	1.75	0.53	0.53
22 AWG / 0.34 mm ²	22	6.71	14	4.27	9	2.74	5.75	1.75	4.5	1.37	3.5	1.07	2.75	0.84	2.75	0.84	0.84
20 AWG / 0.5 mm ²	35	10.67	23	7.01	14	4.27	9	2.74	7	2.13	5.75	1.75	4.5	1.37	4.25	1.30	1.30
18 AWG / 0.75 mm ²	56	17.07	37	11.28	23	7.01	15	4.57	11	3.35	9	2.74	7.5	2.29	7	2.13	2.13
16 AWG / 1.5 mm ²	90	27.44	60	18.29	37	11.28	24	7.32	18	5.49	15	4.57	12	3.66	11	3.35	3.35
14 AWG / 2.5 mm ²	142	43.29	95	28.96	59	17.99	38	11.59	28	8.54	23	7.01	19	5.79	17	5.18	5.18
12 AWG / 4 mm ²	226	68.90	151	46.04	94	28.66	60	18.29	45	13.72	37	11.28	30	9.15	28	8.54	8.54
10 AWG / 6 mm ²	360	109.76	240	73.17	150	45.73	96	29.27	72	21.95	60	18.29	48	14.63	45	13.72	13.72
8 AWG / 10 mm ²	574	175.00	381	116.16	239	72.87	153	46.65	115	35.06	95	28.96	76	23.17	71	21.65	21.65

WIRING DIAGRAMS

0-10V

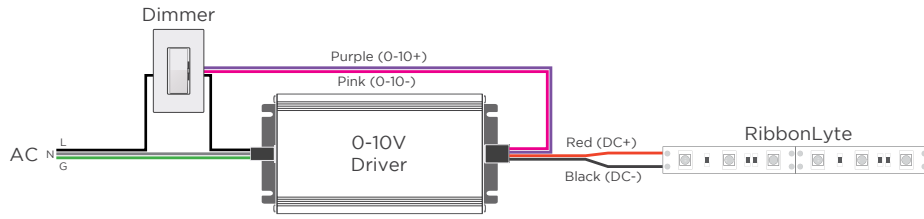

MLV / ELV

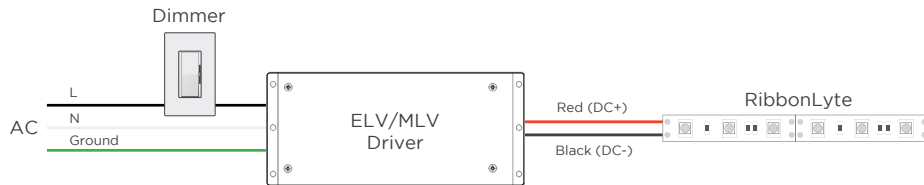

DMX

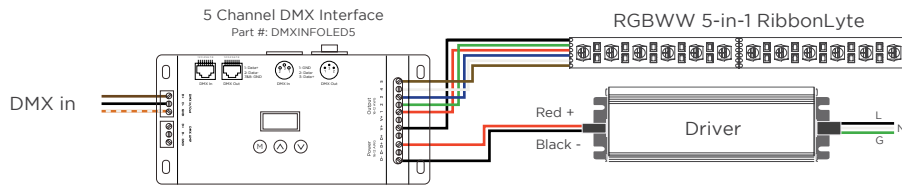

WARM DIM

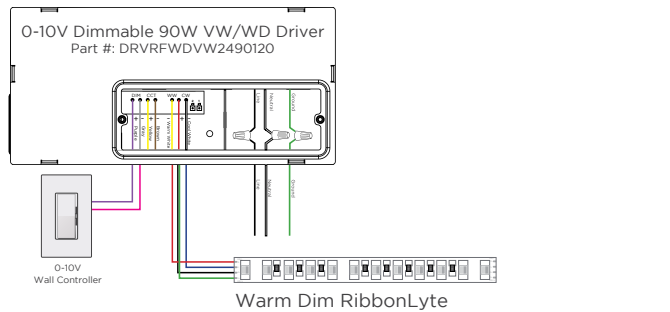

2-CHANNEL VARIABLE WHITE DIMMING

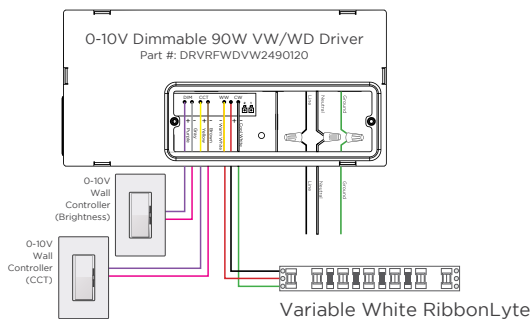

DMX WIRING DIAGRAM - COMPATIBLE WITH ALL MODELS OF VARIABLE WHITE RIBBONLYTE

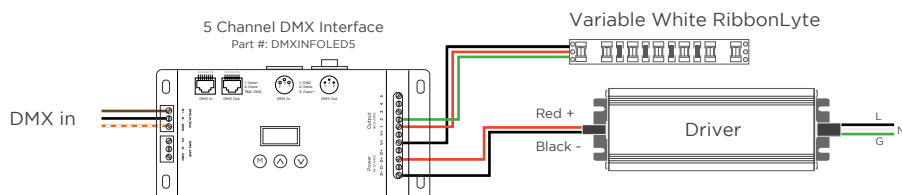

WIRE COLORS PER RIBBONLYTE COLOR

STATIC WHITE + STATIC COLOR

Red Wire (+) Positive
Black Wire (-) Negative

RGBW + RGBA

Black Wire (+) Positive
Green Wire (-) goes to Green Channel
Red Wire (-) goes to Red Channel
Blue Wire (-) goes to Blue Channel
White Wire (-) goes to White Channel

RGBWW

Black (+) Positive
Green Wire (-) goes to Green Channel
Red Wire (-) goes to Red Channel
Blue Wire (-) goes to Blue Channel
White Wire (-) goes to White Channel 1
Brown Wire (-) goes to White Channel 2

WARM DIM

Red Wire (-) goes to Warm White Channel
Blue Wire (-) goes to Cool White Channel
Black Wire (+) goes to Warm White Channel
Green Wire (+) goes to Cool White Channel

VARIABLE WHITE

Black Wire (+) Positive
Red Wire (-) goes to Warm White Channel
Green Wire (-) goes to Cool White Channel