

AS3 CHANNEL FIXTURE

AS3 Channel Fixture is a wide, low profile channel, the widest of the AS series. The 110-degree beam angle creates a wide, even spread of light and is ideal for cove applications. This can be used in conjunction with our tiltable stands, and includes a choice of clear, frosted or milky lens. Custom design a fixture with our AS3 Channel Fixture and RibbonLyte products.

- Available for field assembly or factory assembly
- Beam Angle 110°
- Wattage Range from 0.75 W/ft (2.46 W/m) to 8.8 W/ft (28.9 W/m)
- Static White delivered lumen range from 44.1 lm/ft (144.6 lm/m) up to 729 lm/ft (2392.5 lm/m)
- Assembled in USA

HOUSING FINISHES

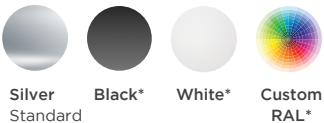

*Additional fee applies

AVAILABLE LENS FINISHES

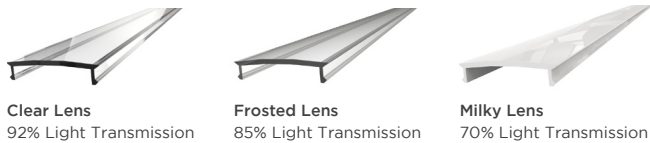

AVAILABLE COLORS & COLOR TEMPERATURES



DIMENSIONS

AS3 Channel	Mounting Clip (Included Accessory)		
<p>Width: 0.93 in. (23.6 mm) Height: 0.42 in. (10.7 mm) Internal Width: 0.81 in. (20.6 mm)</p>	<p>Material: stainless steel</p> <p>Side View</p> <p>Width: 0.6 in. (15 mm) Length: 0.97 in. (24.7 mm) Height: 0.25 in. (6.35 mm)</p>	<p>Top View</p> <p>Width: 0.97 in. (24.7 mm) Height: 0.6 in. (15 mm) Hole Diameter: ø 0.14 in. (3.5 mm)</p>	<p>Assembled View</p> <p>Width: 0.97 in. (24.7 mm) Height: 0.46 in. (11.7 mm)</p>
<p>Note:</p> <ol style="list-style-type: none"> 1. Each section of channel includes 3 mounting clips. 2. Magnetic mounting option available (see page 2) 3. Exterior channel applications should be securely attached to the mounting surface with appropriate screws and/or liquid nails. Acolyte strongly recommends field assembly for exterior applications. Use mounting clips for interior applications only. 			

Acolyte does not warrant or represent that the information is free from errors or omission. The information may change without notice and Acolyte is not in any way liable for the accuracy of any information printed and stored or in any way interpreted or used.

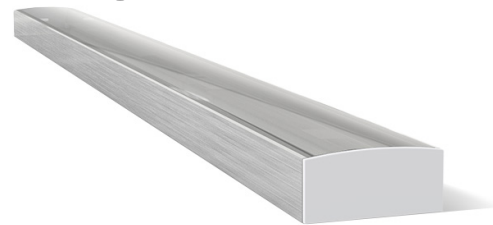

SPECIFICATIONS

Beam Angle	110°
Lens Type	Clear Lens, Frosted Lens, Milky Lens
Length	Channel is sold by the foot and cut to your exact desired length. Required amount of mounting clips included.
Operating Voltage	24 V
Dimming	MLV / 0-10 Volt / ELV / DALI / DMX
Operating Temperature	-40 – 158 °F (-40 – 70 °C)
Colors	1800K, 2000K, 2200K, 2400K, 2700K, 3000K, 3500K, 4000K, 6000K, Red, Amber, Green, Blue, RGBA, RGBW, RGBWW, VW, Warm Dim RGBW Addressable (1800K, 2000K, 2200K only available in IP20), Pixel RGB (IP20 only), RGBW Addressable (IP67 only)
CRI	90+ CRI (Static white only)
Lifetime (L70 reported)	50,000 hours
MacAdam ellipse (SDCM)	1-Step Binning (For Static White LEDs only)
Certifications	UL Listed UL 2108 Issued: 2004/02/27 Ed: 1 Rev: 2014/02/24 Low Voltage Lighting Systems CSA C22.2#9.0 Issued: 1996/06/01 Ed: 1 (R2011) General Requirements for Luminaries; with Gen. Inst. 1: 1997, Gen Inst. 2: 1998. ROHS compliant

ACCESSORIES

<p>Tiltable Stand (Part #: TILTSTANDST)</p> <p>Assembled Height with Channel: 1.22 in. (31 mm)</p>	<p>End Caps (Included Accessory)</p> <p>Material: ABS</p>
--	--

Magnetic Mount (Part #: CHMAGO.5)

Features:

- High-energy neodymium magnets come attached to mounting clips with countersink hex nuts
- Create easy-mount magnetic channels with minimal surface gaps; no tools or drilling necessary
- Magnets rated for 8 lbs. of pull force with static load

Applications:

- Industrial lighting retrofits for troffers and other metal fixtures
- Metal retail shelf lighting
- Temporary light fixture installations

Acolyte does not warrant or represent that the information is free from errors or omission. The information may change without notice and Acolyte is not in any way liable for the accuracy of any information printed and stored or in any way interpreted or used.

ORDERING GUIDE

STEP 1 Complete Channel Part Number

CHANNEL	LENS	HOUSING COLOR
CHAS3		
CHAS3 - AS3 Channel	C - Clear Lens* M - Milky Lens F - Frosted Lens * Clear lens is the default option if not specified.	SV - Silver (default) WH - White** BK - Black**

STEP 2 Complete RibbonLyte Part Number

CATEGORY	CRI	RIBBON TYPE & IP RATING		
RB				
RB - RibbonLyte	0 - Static Color, Color Changing 90 - 90+ CRI Static White	SWS220 - Static White Series 2 IP20 SWS265 - Static White Series 2 IP65 SWS268 - Static White Series 2 IP68 SCS220 - Static Color Series 2 IP20 SCS265 - Static Color Series 2 IP65 SCS268 - Static Color Series 2 IP68 XACTA20 - Xacta RibbonLyte IP20	LINEA20 - Linea RibbonLyte IP20 RGBWS220 - RGBW Series 2 IP20 RGBWS265 - RGBW Series 2 IP65 RGBWS268 - RGBW Series 2 IP68 RGBWW20 - RGBWW 5-in-1 IP20 RGBWADD - Addressable RGBW RGBADD - Pixel RGB IP20	VWS220 - VW Series 2 IP20 VWS265 - VW Series 2 IP65 VWS268 - VW Series 2 IP68 WD20 - Warm Dim IP20 WD65 - Warm Dim IP65 WD68 - Warm Dim IP68

NOTE: To ensure waterproofing standards are met, IP65 and IP68 RibbonLyte can NOT be cut in the field.

** Additional fee applies
Consult factory for custom colors

WATTAGE	COLOR
0.75 - 0.75 W/ft (2.46 W/m - Static White, Static Color)	18 - 1800K RGB27 - Red, Green, Blue + 2700K
1.0 - 1.0 W/ft (3.3 W/m - Variable White)	20 - 2000K RGB30 - Red, Green, Blue + 3000K
1.5 - 1.5 W/ft (4.9 W/m - Static White, Static Color, Variable White)	22 - 2200K RGB40 - Red, Green, Blue + 4000K
2.2 - 2.2 W/ft (7.2 W/m - Static White, Static Color)	24 - 2400K RGB2465 - Red, Green, Blue + 2400K + 6500K
2.4 - 2.4 W/ft (8 W/m - Static White Linea)	27 - 2700K RGBA - Red, Green, Blue + Amber
3.0 - 3.0 W/ft (9.8 W/m - Static White, Static Color, Variable White)	30 - 3000K RGBW30 - RGB + 3000K Addressable
4.3 - 4.3 W/ft (14 W/m - Static White Linea)	35 - 3500K RGBW40 - RGB + 4000K Addressable
4.4 - 4.4 W/ft (14.4 W/m - Static White, Static Color, RGBW, RGBWW, RGBA)	40 - 4000K RGBW60 - RGB + 6000K Addressable
4.5 - 4.5 W/ft (14.8 W/m - Static White, Variable White)	60 - 6000K RGBS - Pixel RGB (SPI)
5.0 - 5.0 W/ft (16.4 W/m - Static White, Static Color)	R - Red VW - Variable White
5.2 - 5.2 W/ft (17.1 W/m - Warm Dim)	A - Amber 2920 - Warm Dim 2900K - 2000K (IP20)
5.3 - 5.3 W/ft (17.5 W/m - Pixel RGB)	G - Green 2721 - Warm Dim 2700K - 2100K (IP65+IP68)
5.5 - 5.5 W/ft (18.0 W/m - RGBW, RGBA)	B - Blue Z - Undecided**
6.0 - 6.0 W/ft (19.7 W/m - Static White, Static Color, Variable White, RGBW Addressable)	
6.1 - 6.1 W/ft (20 W/m - Variable White Linea)	
8.8 - 8.8 W/ft (28.9 W/m - RGBW, RGBWW)	

** For quotes only. Must be chosen before final order.

CONNECTION OPTIONS (See diagrams on the right)

Custom Length (ft.)

- 1 - End Feed Bare Wire Connection
- 2 - Back Feed Bare Wire Connection
- 3 - Side Feed Bare Wire Connection
- 4 - End Feed with IP67 Male Coupler
- 5 - Soldered Daisy Chain
- 6 - Daisy Chain With IP67 Couplers

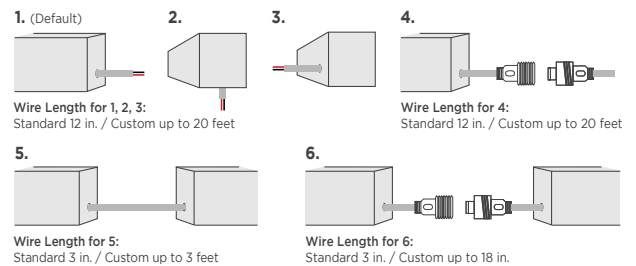

STEP 3 Complete Assembly Option & Length

ASSEMBLY OPTION	LENGTH (Standard factory assembled length up to 6 ft 6.7 in. / 2 m)
FI - Field Assembly	
FA - Factory Assembly*** (not recommended for exterior applications)	

*** Factory assembled runs exceeding 6 ft 6.7 in. (2 m) will be split into multiple daisy chained fixtures.

STEP 4 Add Accessories

ACCESSORIES	
TILTSTANDST - Tiltable Stand	CHMAGO.5 - Magnetic Mount

DO NOT BUTT END CAPS AGAINST EACH OTHER WHEN CREATING LONGER FIXTURES
Acolyte STRONGLY SUGGESTS field assembly (without using interior end caps) for direct-view fixtures of more than 6 ft 6.7 in. (2 m) in length. Field assembly without interior end caps will eliminate gaps or dead spots that can be caused by butting interior end caps against each other.

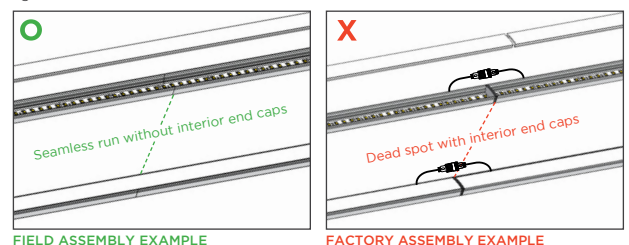

RIBBONLYTE SPECIFICATIONS & COMPATIBILITY

Available Wattages	Cutttable Length	LED Pitch	Color Temp.	lm/W without Lens	Delivered Lumens with Clear Lens		Delivered Lumens with Frosted Lens		Delivered Lumens with Milky Lens		Max Length	Compatible with Channel		
					lm/ft	lm/m	lm/ft	lm/m	lm/ft	lm/m		IP20	IP65	IP68
0.75 Static White Series 2	1.97 in. (50 mm)	48 LEDs/ft (160 LEDs/m)	1800K	84	58	190.3	53.6	175.8	44.1	144.6	IP20: 49 ft (15 m) IP65: 32.8 ft (10 m)	✓	✓	✓
			2000K	99	68.3	224	63.1	207	52	170.6				
			2200K	109	75.2	246.7	69.5	228	57.2	187.6				
			2400K	113	78	255.8	72	236.2	59.3	194.5				
			2700K	123	84.9	278.5	78.4	257.2	64.6	211.9				
			3000K	123	84.9	278.5	78.4	257.2	64.6	211.9				
			3500K	130	89.7	294.2	82.9	272	68.3	224				
			4000K	134	92.5	303.4	85.4	280.1	70.4	230.9				
6000K	131	90.4	296.5	83.5	273.9	68.8	225.7							
1.5 Static White Series 2	1.97 in. (50 mm)	48 LEDs/ft (160 LEDs/m)	1800K	84	115.9	380.2	107.1	351.3	88.2	289.3	IP20: 49 ft (15 m) IP65: 32.8 ft (10 m)	✓	✓	✓
			2000K	98	135.2	443.5	125	410	102.9	337.5				
			2200K	109	150.4	493.3	139	455.9	114.5	375.6				
			2400K	113	155.9	511.4	144.1	472.6	118.7	389.3				
			2700K	123	169.7	556.6	156.8	514.3	129.2	423.8				
			3000K	123	169.7	556.6	156.8	514.3	129.2	423.8				
			3500K	129	178	583.8	164.5	539.6	135.5	444.4				
			4000K	134	184.9	606.5	170.9	560.6	140.7	461.5				
6000K	131	180.8	593	167	547.8	137.6	451.3							
2.2 Static White Series 2	1.97 in. (50 mm)	48 LEDs/ft (160 LEDs/m)	1800K	83	168	51	155.2	509.1	127.8	419.2	IP20: 42 ft (12.8 m) IP65: 32.8 ft (10 m)	✓	✓	✓
			2000K	96	194.3	637.3	179.5	588.8	147.8	484.8				
			2200K	106	214.5	703.6	198.2	650.1	163.2	535.3				
			2400K	111	224.7	737	207.6	680.9	170.9	560.6				
			2700K	120	242.9	796.7	224.4	736	184.8	606.1				
			3000K	122	246.9	809.8	228.1	748.2	187.9	616.3				
			3500K	127	257	843	237.5	779	195.6	641.6				
			4000K	133	269.2	883	248.7	779	204.8	671.7				
6000K	128	259.1	849.8	239.4	785.2	197.1	646.5							
3.0 Static White Series 2	1.97 in. (50 mm)	48 LEDs/ft (160 LEDs/m)	1800K	84	231.8	760.4	214.2	702.6	176.4	578.6	IP20: 36 ft (11 m) IP65: 32.8 ft (10 m)	✓	✓	✓
			2000K	98	270.5	887.2	249.9	819.7	205.8	675				
			2200K	108	298.1	977.7	275.4	903.3	226.8	743.9				
			2400K	109.8	303.1	994.1	280.1	918.6	230.6	756.5				
			2700K	122.9	339.6	1114	313.5	1028.1	258.1	846.7				
			3000K	130	359.1	1177.9	331.4	1087.1	273	895.3				
			3500K	133	367.5	1205.3	339.2	1112.4	279.3	916.1				
			4000K	133	367.5	1205.3	339.2	1112.4	279.3	916.1				
6000K	127	350.8	1150.5	323.7	1061.8	266.6	874.5							
4.4 Static White Series 2	1.97 in. (50 mm)	48 LEDs/ft (160 LEDs/m)	1800K	81	327.9	1075.5	302.9	993.6	249.5	818.3	28 ft 4 in. (8.64 m)	✓	✓	✓
			2000K	95	384.6	1261.4	355.3	1165.4	292.6	959.7				
			2200K	105	425	1394.1	392.7	1288.1	323.4	1060.8				
			2400K	109	441.2	1447	407.7	1337.1	335.7	1101.2				
			2700K	124	494.4	1621.6	456.3	1496.6	375.8	1232.5				
			3000K	131	522.8	1714.7	482.5	1582.5	397.3	1303.2				
			3500K	133	534.9	1754.5	493.7	1619.3	406.6	1333.5				
			4000K	133	534.9	1754.5	493.7	1619.3	406.6	1333.5				
6000K	128	510.6	1674.8	471.2	1545.7	388.1	1272.9							
5.0 Static White Series 2	1.4 in. (35.7 mm)	68 LEDs/ft (224 LEDs/m)	1800K	83	381.8	1252.3	352.8	1157	290.5	952.8	IP20: 33 ft 4 in. (10.1 m) IP65: 32.8 ft (10 m)	✓	✓	
			2000K	98	450.8	1478.6	416.5	1366.1	343	1125				
			2200K	107	492.2	1614.4	454.8	1491.6	374.5	1228.4				
			2400K	110	505.1	1656.8	466.8	1531	384.4	1260.8				
			2700K	124	566.1	1856.7	522.4	1713.6	430.2	1411.2				
			3000K	134	598.5	1963.2	552.4	1811.9	454.9	1492.1				
			3500K	135	612.5	2008.9	565.3	1854	465.5	1526.8				
			4000K	134	612.5	2008.9	565.3	1854	465.5	1526.8				
6000K	130	584.6	1917.6	539.6	1769.7	444.3	1457.4							
6.0 Static White Series 2	1.4 in. (35.7 mm)	68 LEDs/ft (224 LEDs/m)	1800K	82	452.6	1484.7	418.2	1371.7	344.4	1129.6	28 ft (8.5 m)	✓	✓	
			2000K	95	524.4	1720	484.5	1589.2	399.0	1308.7				
			2200K	106	585.1	1919.2	540.6	1773.2	445.2	1460.3				
			2400K	109	601.6	1973.2	555.9	1823.4	457.8	1501.6				
			2700K	122	674.2	2211.3	622.2	2040.8	512.4	1680.7				
			3000K	129	712.9	2338.2	657.9	2157.9	541.8	1777.1				
			3500K	132	729.4	2392.5	673.2	2208.1	554.4	1818.4				
			4000K	132	729.4	2392.5	673.2	2208.1	554.4	1818.4				
6000K	126	696.3	2283.8	642.6	2107.7	529.2	1735.8							

RIBBONLYTE SPECIFICATIONS & COMPATIBILITY

Available Wattages	Cuttable Length	LED Pitch	Color Temp.	lm/W without Lens	Delivered Lumens with Clear Lens		Delivered Lumens with Frosted Lens		Delivered Lumens with Milky Lens		Max Length	Compatible with Channel		
					lm/ft	lm/m	lm/ft	lm/m	lm/ft	lm/m		IP20	IP65	IP68
0.75 Static Color Series 2	1.97 in. (50 mm)	48 LEDs/ft (160 LEDs/m)	Red	41	28	93	26	86	22	70.6	IP20: 49 ft (15 m) IP65/ IP68: 32.8 ft (10 m)	✓	✓	✓
			Green	175	121	396	112	366	92	301.4				
			Blue	19	13	43	12	40	10	32.7				
			Amber	34	23	77	22	71	18	58.6				
1.5 Static Color Series 2	1.97 in. (50 mm)	48 LEDs/ft (160 LEDs/m)	Red	42	58	190	54	176	44	144.7	IP20: 49 ft (15 m) IP65/ IP68: 32.8 ft (10 m)	✓	✓	✓
			Green	160	221	724	204	669	168	551.1				
			Blue	18	25	81	23	75	19	62				
			Amber	34	47	154	43	142	36	117.1				
2.2 Static Color Series 2	1.97 in. (50 mm)	48 LEDs/ft (160 LEDs/m)	Red	42	85	279	79	258	65	212.2	IP20: 42 ft (12.8 m) IP65/ IP68: 32.8 ft (10 m)	✓	✓	✓
			Green	145	293	963	271	889	223	732.4				
			Blue	18	36	119	34	110	28	90.9				
			Amber	33	67	219	62	202	51	166.7				
3.0 Static Color Series 2	1.97 in. (50 mm)	48 LEDs/ft (160 LEDs/m)	Red	40	110.4	362.1	102	334.6	84	275.52	32.8 ft (10 m)	✓	✓	✓
			Green	127	350.9	1151	323.9	1062.2	266.7	874.78				
			Blue	25	69.1	226.6	63.8	209.1	52.5	172.2				
			Amber	29	80.1	262.8	74	242.6	60.9	199.75				
4.4 Static Color Series 2	1.97 in. (50 mm)	48 LEDs/ft (160 LEDs/m)	Red	38	153.8	504.5	142.1	466.2	117	383.89	29 ft (8.8 m)	✓	✓	✓
			Green	117	474.1	1555.1	437.6	1435.3	360.4	1181.98				
			Blue	24	97.3	319	89.8	294.4	73.9	242.46				
			Amber	25	101.3	332.2	93.5	306.7	77	252.56				
5.0 Static Color Series 2	1.4 in. (35.7 mm)	68 LEDs/ft (224 LEDs/m)	Red	37	170.2	558.2	157.3	515.8	129.5	424.76	30 ft (9.14 m)	✓	✓	✓
			Green	116	534.2	1752.1	493	1617	406	1331.68				
			Blue	24	110.5	362.5	102	334.6	84	275.52				
			Amber	26	119.7	392.7	110.5	362.4	91	298.48				
6.0 Static Color Series 2	1.4 in. (35.7 mm)	68 LEDs/ft (224 LEDs/m)	Red	37	204.2	669.8	188.7	618.9	155.4	509.71	28 ft (8.5 m)	✓	✓	✓
			Green	113	624.4	2048.2	576.3	1890.3	474.6	1556.6				
			Blue	23	127.1	416.9	117.3	384.8	96.6	316.9				
			Amber	24	132.6	435	122.4	401.6	100.8	330.7				
2.4 Static White Linea	1.97 in. (50 mm)	146 LEDs/ft (480 LEDs/m)	2700K	67	148.1	485.8	136.9	448.8	112.7	369.6	21.3 ft (6.5 m)	✓	N/A	N/A
			3000K	71	156.4	514.3	144.5	475.2	119	391.3				
			3500K	83	183.1	601.7	169.2	555.9	139.3	457.8				
			4000K	83	183.1	601.7	169.2	555.9	139.3	457.8				
3.0 Static White Linea	1.97 in. (50 mm)	146 LEDs/ft (480 LEDs/m)	2700K	66	182.2	598	168.3	552.5	138.6	455	21.3 ft (6.5 m)	✓	N/A	N/A
			3000K	73	201.5	661.5	186.2	611.2	153.3	503.3				
			3500K	78	215.3	706.6	198.9	652.8	163.8	537.6				
			4000K	83	229.1	751.6	211.7	694.5	174.3	571.9				
4.3 Static White Linea	1.97 in. (50 mm)	146 LEDs/ft (480 LEDs/m)	2700K	75	297.2	973.4	274.6	899.3	226.1	740.6	24.6 ft (7.5 m)	✓	N/A	N/A
			3000K	78	308.2	1012	284.8	935	234.5	770				
			3500K	86	340.4	1116.9	314.5	1031.9	259	849.8				
			4000K	86	340.4	1116.9	314.5	1031.9	259	849.8				
6.1 Variable White Linea	1.09 in. (27.78 mm)	175 LEDs/ft (576 LEDs/m)	2700K + 6500K	95	533.6	1750.8	493	1617.6	406	1332.1	16.4 ft (5 m)	✓	N/A	N/A





RIBBONLYTE SPECIFICATIONS & COMPATIBILITY

Available Wattages	Cuttable Length	LED Pitch	Color Temp.	lm/W without Lens	Delivered Lumens with Clear Lens		Delivered Lumens with Frosted Lens		Delivered Lumens with Milky Lens		Max Length	Compatible with Channel		
					lm/ft	lm/m	lm/ft	lm/m	lm/ft	lm/m		IP20	IP65	IP68
1.5 Static White Xacta	0.2 in. (5 mm)	61 LEDs/ft (200 LEDs/m)	1800K	71	110.2	361.6	101.8	334.1	83.9	275.1	32.74 ft (9.98 m)	✓	n/a	n/a
			2000K	84	130.1	426.8	120.2	394.3	99	324.7				
			2200K	92	142.7	468.3	131.9	432.6	108.6	356.3				
			2400K	96	148.2	486.1	136.9	449.1	112.7	369.8				
			2700K	109	168	551.3	155.3	509.3	127.9	419.4				
			3000K	113	175.3	575	161.9	531.2	133.4	437.5				
			3500K	117	180.7	592.8	166.9	547.7	137.5	451				
			4000K	115	177.1	580.9	163.6	536.7	134.7	442				
			6000K	112	173.5	569	160.3	525.7	132	433				
3.0 Static White Xacta	0.2 in. (5 mm)	61 LEDs/ft (200 LEDs/m)	1800K	71	196.3	643.9	181.3	594.9	149.3	489.9	23.62 ft (7.2 m)	✓	n/a	n/a
			2000K	84	231.6	760	214	702.2	176.2	578.3				
			2200K	92	254.2	833.9	234.8	770.5	193.4	634.5				
			2400K	95	263.8	865.6	243.7	799.7	200.7	658.6				
			2700K	108	299.2	981.7	276.4	907	227.7	747				
			3000K	113	312.1	1023.9	288.3	946	237.4	779.1				
			3500K	116	321.7	1055.6	297.2	975.3	244.8	803.2				
			4000K	114	315.3	1034.5	291.3	955.8	239.9	787.1				
			6000K	111	308.9	1013.4	285.4	936.3	235	771.1				
4.5 Static White Xacta	0.2 in. (5 mm)	61 LEDs/ft (200 LEDs/m)	1800K	72	299.6	983	276.8	908.2	228	747.9	19.03 ft (5.8 m)	✓	n/a	n/a
			2000K	85	353.7	1160.3	326.7	1072	269.1	882.8				
			2200K	93	388	1273.1	358.5	1176.2	295.2	968.6				
			2400K	97	402.8	1321.4	372.1	1220.9	306.5	1005.4				
			2700K	110	456.8	1498.7	422	1384.6	347.6	1140.3				
			3000K	114	476.5	1563.1	440.2	1444.2	362.5	1189.3				
			3500K	118	491.2	1611.5	453.8	1488.9	373.7	1226.1				
			4000K	116	481.4	1579.2	444.7	1459.1	366.3	1201.6				
			6000K	113	471.5	1547	435.7	1429.3	358.8	1177.1				
1.5 Variable White Xacta	0.2 in. (5 mm)	122 LEDs/ft (400 LEDs/m)	2400K + 6000K	138	189.1	620.4	174.7	573.2	143.9	472	32.15 ft (9.8 m)	✓	n/a	n/a
3.0 Variable White Xacta	0.2 in. (5 mm)	122 LEDs/ft (400 LEDs/m)	2400K + 6000K	136	371.1	1217.7	342.9	1125.1	282.4	926.5	22.31 ft (6.8 m)	✓	n/a	n/a
4.5 Variable White Xacta	0.2 in. (5 mm)	122 LEDs/ft (400 LEDs/m)	2400K + 6000K	134	524.2	1719.8	484.3	1588.9	398.9	1308.5	19.03 ft (5.8 m)	✓	n/a	n/a
1.0 Variable White Series 2	1.97 in. (50 mm)	42 LEDs/ft (140 LEDs/m)	2000K + 6500K	85	78.2	257	72.3	237	60	200	32.8 ft (10 m)	✓	✓	✓
3.0 Variable White Series 2	1.97 in. (50 mm)	42 LEDs/ft (140 LEDs/m)	2000K + 6500K	80	220.8	725	205	670	168	551.2	32.8 ft (10 m)	✓	✓	✓
6.0 Variable White Series 2	1.97 in. (50 mm)	42 LEDs/ft (140 LEDs/m)	2000K + 6500K	75	415	1362	382.5	1255	315	1033.5	19 ft 8 in. (6 m)	✓	✓	✓
4.4 RGB Series 2	1.97 in. (50 mm)	36 LEDs/ft (120 LEDs/m)	RGBW	45	188.1	617.2	168.3	552.2	148.5	487.2	19 ft 8 in. (6 m)	✓	N/A	N/A
5.5 RGB Series 2	1.97 in. (50 mm)	36 LEDs/ft (120 LEDs/m)	RGBW	59	308.8	1013	275.8	904.9	243.3	798.5	16 ft 4 in. (5 m)	N/A	✓	✓
8.8 RGB Series 2	1.97 in. (50 mm)	36 LEDs/ft (120 LEDs/m)	RGBW	61	510.2	1673.8	456.3	1497.1	402.6	1320.9	16 ft 4 in. (5 m)	✓	N/A	N/A
4.4 5-in-1 RGBWW	2.46 in. (62.5 mm)	29 LED/ft (96 LED/m)	RGBWW	59	241.4	792.1	220.7	724	194.7	638.8	16 ft 4 in (5 m)	✓	N/A	N/A
8.8 5-in-1 RGBWW	2.46 in. (62.5 mm)	29 LED/ft (96 LED/m)	RGBWW	50	409.2	1342.6	374	1227.1	330	1082.7	11 ft 6 in (3.5 m)	✓	N/A	N/A
RGBW Addressable	3.94 in. (100 mm)	18 LEDs/ft (60 LEDs/m)	Red	33.5	30.8	101.2	28.5	93.5	23.5	77.1	16 ft 5.64 in. (5.02 m)	N/A	N/A	✓ IP67
			Green	82	75.4	247.5	69.7	228.7	57.4	188.3				
			Blue	15.5	14.2	46.7	13.2	43.2	10.8	35.6				
			White	103	94.8	310.9	87.6	287.3	72.1	236.6				
			All	40	222.8	730.8	205.8	675.2	169.5	556.1				
5.3 Pixel RGB	3.94 in. (100 mm)	18 LEDs/ft (60 LEDs/m)	RGB (all on)	21	114.54	375.36	105.83	346.8	87.15	285.6	24 ft 7.2 in. (7.5 m)	✓	n/a	n/a
5.2 Warm Dim	3.94 in. (100 mm)	36 LEDs/ft (120 LEDs/m)	WARM DIM	55	263.1	863	244.8	803.25	201.6	661.5	16 ft 4 in. (5 m)	✓	✓	✓

DIODE VISIBILITY CHART (Data below applies to installations with Milky lens only)

 No Visible Diode = N Note: Linea RibbonLyte has no visible diode					 With Visible Diode = Y									
Static White & Static Color Series 2			Static White & Static Color Xacta		RGBW & RGBA Series 2		5-in-1 RGBWW	5-in-1 RGBWW	Pixel RGB	RGBW Addressable	Variable White Series 2	Warm Dim		
0.75/1.5/2.2	3.0/4.4		5.0/6.0		1.5/3.0/4.5		4.4/8.8	5.5	4.4	8.8	5.3	6.0	1.0/3.0/6.0	5.2
IP20/IP65/IP68	IP20/IP65	IP68	IP20/IP65/IP68		IP20	IP20	IP65/IP68	IP20	IP20	IP20	IP67	IP20/IP65/IP68	IP20/IP65/IP68	
Y	N	Y	N		N	Y	Y	Y	Y	Y	Y	Y	Y	

AVAILABLE DRIVERS / CONTROLLERS AND DIMMING OPTIONS / WIRE GAUGE CHART

0-10V/ELV/MLV 3-IN-1	ELV	0-10V VW/WD	COMPACT
			
<p>60W, 96W, 288W 0-10V/ELV/MLV 3-in-1 Dimmable Drivers</p> <p>Part No.:</p> <ul style="list-style-type: none"> • DRVW2460TRI010 (60 W) • DRVW2496TRI010 (96 W) • DRVW24288TRI010 (288 W) <p>24 VDC 120-277 VAC IP65, dry/damp/wet locations UL Listed</p>	<p>60W Dimmable Driver</p> <p>Part No.:</p> <ul style="list-style-type: none"> • DRVW2460ELV <p>24 VDC 100-130 VAC Fits in single-gang switch boxes IP20, dry locations UL Recognized</p>	<p>0-10V Dimmable 90W VW/WD Driver</p> <p>Part No.:</p> <ul style="list-style-type: none"> • DRVRFWDVW2490120 <p>24 VDC 100-277 VAC IP23, dry/damp locations UL Listed</p>	<p>60W, 96W Non-Dimming Compact Drivers</p> <p>Part No.:</p> <ul style="list-style-type: none"> • DRV2460C (60 W) • DRV2496C (96 W) <p>24 VDC 120-277 VAC IP20, dry locations UL Class P</p>

ATHENA WIRELESS COMPATIBLE	CASAMBI COMPATIBLE DRIVERS	DIMMABLE DALI-2 DRIVERS	DIMMABLE DALI-2 DRIVERS
			
<p>94W Athena Wireless Compatible Drivers</p> <p>Part No.:</p> <ul style="list-style-type: none"> • DRVW2494ATH1CH (1 channel) • DRVW2494ATH2CH (2 channel) <p>24 VDC 100-277 VAC Dry locations UL Listed</p>	<p>100W & 200W Casambi Compatible 4 Channel Drivers</p> <p>Part No.:</p> <ul style="list-style-type: none"> • DRVW24100CAS4CH (100 W) • DRVW24200CAS4CH (200 W) <p>24 VDC 100-277 VAC IP66, dry/damp/wet locations UL Listed, CE, RoHS, Bluetooth, CASAMBI</p>	<p>96W DIMMABLE DALI-2 DT6 D4I & DALI-2 DT8 D4I DRIVERS</p> <p>Part No.:</p> <ul style="list-style-type: none"> • DRVW2496DALI1CH (1 channel) • DRVW2496DALI2CH (2 channel) <p>24-26 VDC 120-277 VAC IP67, dry/damp/wet locations UL Listed</p>	<p>75W, 150W, 240W DALI-2 Dimmable Drivers</p> <p>Part No.:</p> <ul style="list-style-type: none"> • DRVW2475DALI1CH (75 W, 1 channel) • DRVW24150DALI1CH (150 W, 1 channel) • DRVW24240DALI1CH (240 W, 1 channel) • DRV24150DALI2CH (150 W, 2 channels) • DRV24150DALI4CH (150 W, 4 channels) <p>24 VDC 120-277 VAC IP67, damp/wet locations (1-channel drivers only) IP20, dry location (2-channel & 4-channel drivers only) CE, RoHS, SELV</p>

DMX CONTROLLERS, VARIABLE WHITE DIMMER, WARM DIM DIMMER - FOR COLOR CHANGING FIXTURES

				
<p>GLASS TOUCH WALL CONTROLLERS</p> <p>Part No.:</p> <ul style="list-style-type: none"> • AWCRGBWBK • AWCVWBK 	<p>1 ZONE WALL CONTROLLER</p> <p>Part No.: DMXCTRLG</p>	<p>5 ZONE WALL CONTROLLER</p> <p>Part No.: DMXCTRL</p>	<p>10 ZONE WALL CONTROLLER</p> <p>Part No.: DMXCTRLD</p>	<p>6 UNIVERSE DMX CONTROLLER</p> <p>Part No.: DMXCTRLDR6U</p>
				
<p>VARIABLE WHITE DIMMER</p> <p>Part No.:</p> <ul style="list-style-type: none"> • RFDIMVWWH (White) • RFDIMVWBK (Black) 	<p>WARM DIM DIMMER</p> <p>Part No.:</p> <ul style="list-style-type: none"> • RFDIMWDWH (White) • RFDIMWDBK (Black) 	<p>4 CHANNEL WATERPROOF DMX INTERFACE</p> <p>Part No.: DMXINFWLC4D</p>	<p>5 CHANNEL DMX DECODER</p> <p>Part No.: DMXINF5</p>	<p>DMX OPTO SPLITTER</p> <p>Part No.: DMXOS8</p>

Wattages	30		60		96		150		200		240		300		320	
	Feet	Meters	Feet	Meters	Feet	Meters	Feet	Meters	Feet	Meters	Feet	Meters	Feet	Meters	Feet	Meters
24 AWG / 0.25 mm ²	14	4.27	9	2.74	5.5	1.68	3.75	1.14	2.75	0.84	2.25	0.69	1.75	0.53	1.75	0.53
22 AWG / 0.34 mm ²	22	6.71	14	4.27	9	2.74	5.75	1.75	4.5	1.37	3.5	1.07	2.75	0.84	2.75	0.84
20 AWG / 0.5 mm ²	35	10.67	23	7.01	14	4.27	9	2.74	7	2.13	5.75	1.75	4.5	1.37	4.25	1.30
18 AWG / 0.75 mm ²	56	17.07	37	11.28	23	7.01	15	4.57	11	3.35	9	2.74	7.5	2.29	7	2.13
16 AWG / 1.5 mm ²	90	27.44	60	18.29	37	11.28	24	7.32	18	5.49	15	4.57	12	3.66	11	3.35
14 AWG / 2.5 mm ²	142	43.29	95	28.96	59	17.99	38	11.59	28	8.54	23	7.01	19	5.79	17	5.18
12 AWG / 4 mm ²	226	68.90	151	46.04	94	28.66	60	18.29	45	13.72	37	11.28	30	9.15	28	8.54
10 AWG / 6 mm ²	360	109.76	240	73.17	150	45.73	96	29.27	72	21.95	60	18.29	48	14.63	45	13.72
8 AWG / 10 mm ²	574	175.00	381	116.16	239	72.87	153	46.65	115	35.06	95	28.96	76	23.17	71	21.65

WIRING DIAGRAMS - STATIC WHITE / STATIC COLOR / RGBW / RGBA / RGBWW

0-10 V

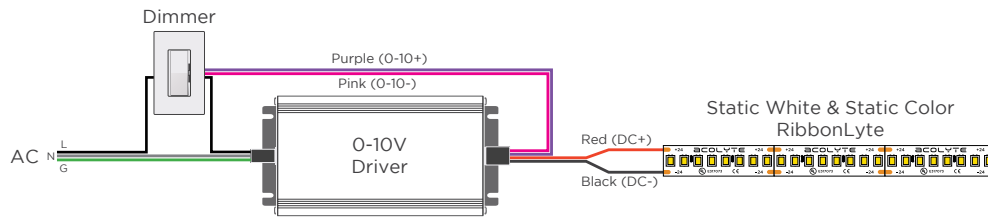

MLV / ELV

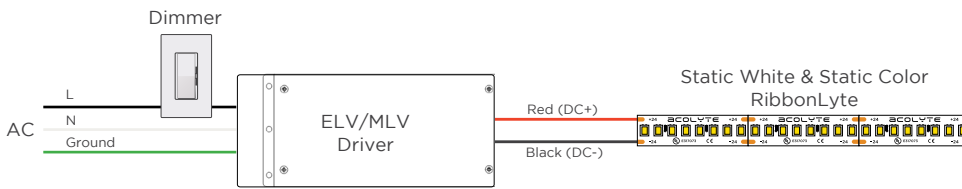

DMX WIRING WITH STATIC WHITE & STATIC COLOR RIBBONLYTE

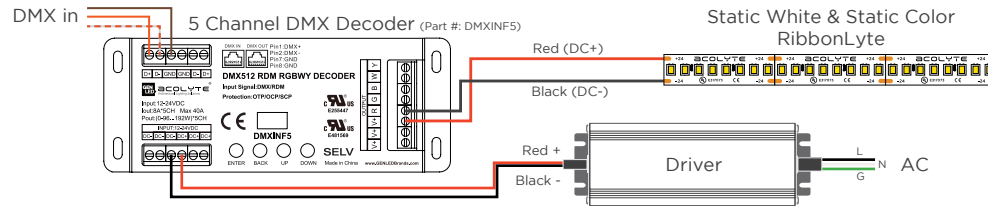

DALI-2 WIRING WITH STATIC WHITE & STATIC COLOR RIBBONLYTE

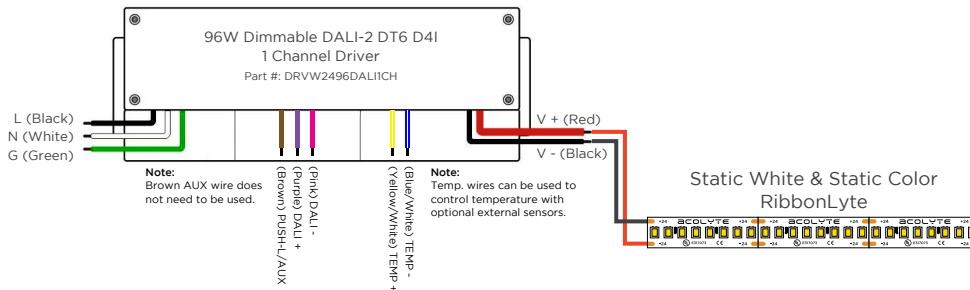

STATIC WHITE & STATIC COLOR RIBBONLYTE WIRING WITH ATHENA WIRELESS COMPATIBLE DRIVER

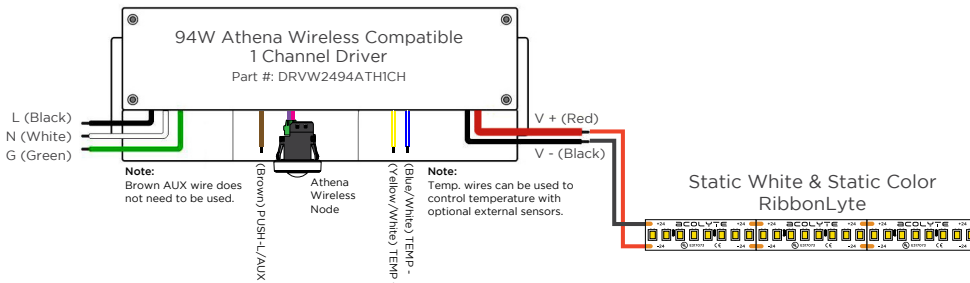

DMX WITH RGBWW 5-IN-1 RIBBONLYTE

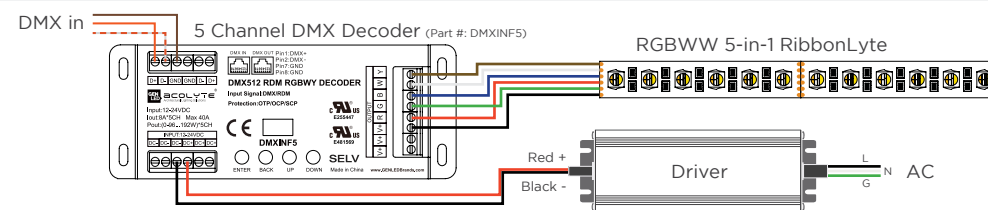

WIRE COLORS PER RIBBONLYTE COLOR

STATIC WHITE + STATIC COLOR

Red Wire (+) Positive
Black Wire (-) Negative

RGBW + RGBA

Black Wire (+) Positive
Green Wire (-) goes to Green Channel
Red Wire (-) goes to Red Channel
Blue Wire (-) goes to Blue Channel
White Wire (-) goes to White Channel

RGBWW

Black (+) Positive
Green Wire (-) goes to Green Channel
Red Wire (-) goes to Red Channel
Blue Wire (-) goes to Blue Channel
White Wire (-) goes to White Channel 1
Brown Wire (-) goes to White Channel 2

WIRING DIAGRAMS - VARIABLE WHITE

2-CHANNEL VARIABLE WHITE DIMMING

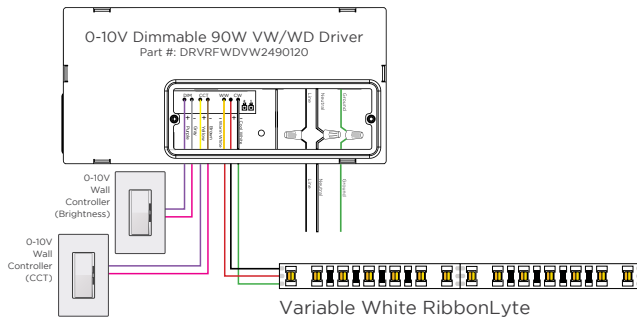

WIRE COLORS PER RIBBONLYTE COLOR

VARIABLE WHITE
Black Wire (+) Positive
Red Wire (-) goes to Warm White Channel
Green Wire (-) goes to Cool White Channel

DMX WIRING WITH VARIABLE WHITE RIBBONLYTE

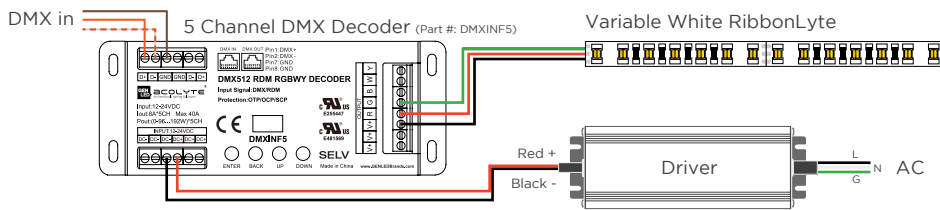

DALI-2 WIRING WITH VARIABLE WHITE RIBBONLYTE

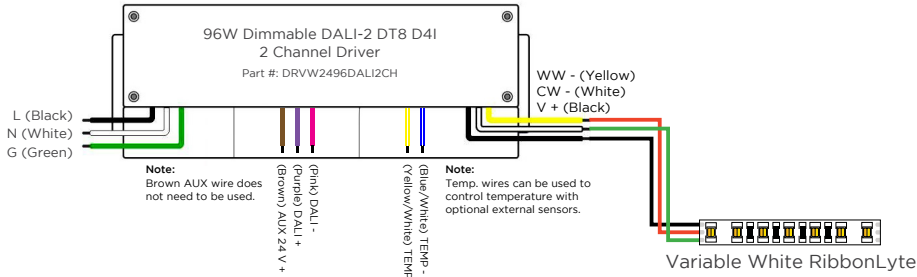

VARIABLE WHITE RIBBONLYTE WIRING WITH ATHENA WIRELESS COMPATIBLE DRIVER

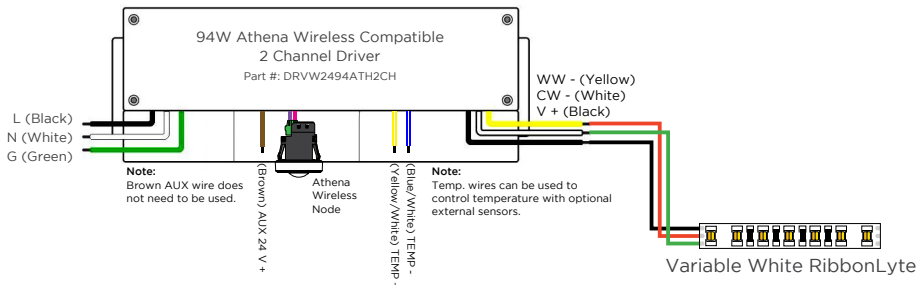





WIRING DIAGRAMS WITH RGBW ADDRESSABLE RIBBONLYTE

One DMX Universe consists of 128 addresses and 512 channels (42 ft / 12.8 m of RibbonLyte).

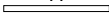
Any single run of RibbonLyte that is less than 16 ft, 4 in. can be wired directly to the controller.

For additional runs, Opto Splitter must be used. Each individual run will need its own Opto Splitter output.

WIRE INDEX	
+	
PI	
A+	
B-	
GND	

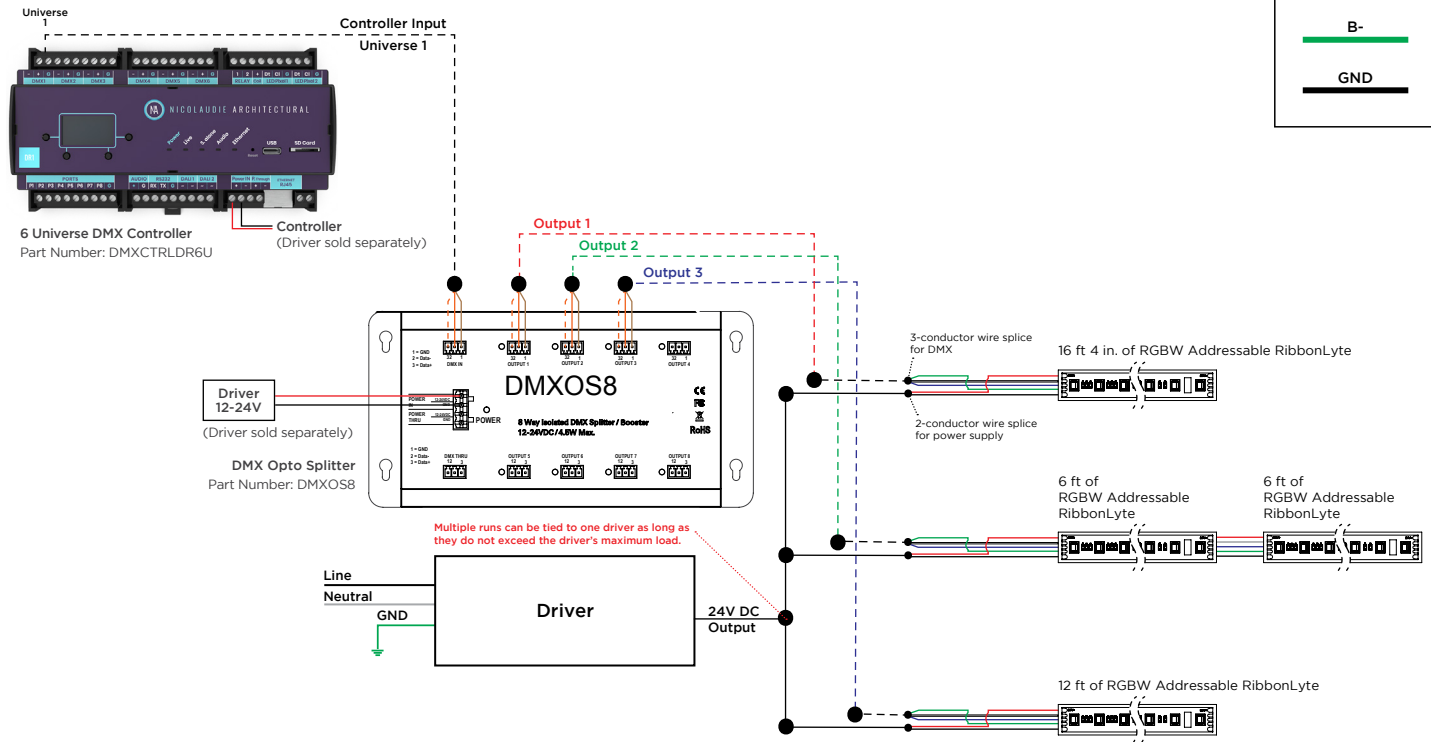

REV.24JUN2026

GLOBAL HQ

320 Murray Hill Pkwy
East Rutherford, NJ 07073
U.S.
T: (+1) 212 629 6830
E: Sales-US@GENLEDBrands.com

EUROPEAN HQ

Hogeweyselaan 119
1382 JK Weesp
Netherlands
T: (+31) 346 235 000
E: SalesEurope@GENLEDBrands.com

MEINA HQ

PO Box 371378, #823, Building 4EA
Dubai Airport Free Zone
Dubai, UAE
T: (+971) 4 701 7901
E: SalesMEINA@genledbrands.com

ASIA-PACIFIC HQ

Room 402, Building D
Shenshi Tongchuang Science and Technology Park
No. 16 Hongyin Road
Xingqiang Community, Xihu Street
Guangming District, Shenzhen, China 518107
T: (+86) 755 8529 0710
E: Sales-Pacific@GENLEDBrands.com