

### AS6 CHANNEL FIXTURE

Our AS6 Channel Fixture is a medium width, low profile channel with a 110-degree beam angle ideal for a wide, even spread of light. This channel is ideal for cove and toe kick applications, and can also be used in conjunction with our tiltable stands. The AS6 Channel includes choice of clear, frosted or milky lens. Custom design a fixture with our AS6 Channel and RibbonLyte products.

- Available for field assembly or factory assembly
- Beam Angle 110°
- Wattage Range from 0.75 W/ft (2.46 W/m) to 8.8 W/ft (28.9 W/m)
- Static White delivered lumen range from 44.1 lm/ft (144.6 lm/m) up to 729 lm/ft (2392.5 lm/m)
- Assembled in USA

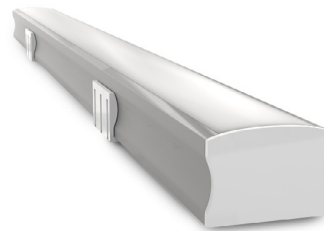

### HOUSING FINISHES

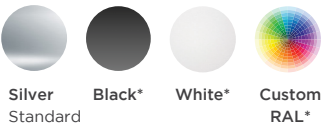

\*Additional fee applies

### AVAILABLE LENS FINISHES

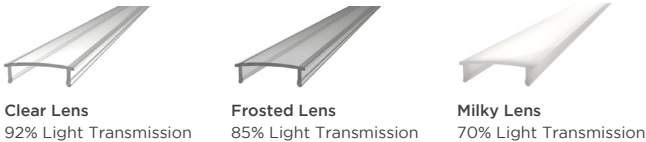

### AVAILABLE COLORS & COLOR TEMPERATURES



### DIMENSIONS

AS6 Channel	Mounting Clip (Included Accessory)
<p><b>Width:</b> 0.89 in. (22.5 mm)  <b>Height:</b> 0.62 in. (15.7 mm)  <b>Internal Width:</b> 0.71 in. (18 mm)</p>	<p>Material: stainless steel</p> <div style="display: flex; justify-content: space-around;"> <div> <p><b>Side View</b></p> <p><b>Width:</b> 0.36 in. (9.14 mm)  <b>Length:</b> 1.01 in. (25.7 mm)  <b>Height:</b> 0.36 in. (9.14 mm)</p> </div> <div> <p><b>Top View</b></p> <p><b>Width:</b> 0.35 in. (9 mm)  <b>Length:</b> 1.01 in. (25.7 mm)  <b>Hole Diameter:</b> 0.16 in. (4 mm)</p> </div> <div> <p><b>Assembled View</b></p> <p><b>Height:</b> 0.68 in. (17.3 mm)  <b>Width:</b> 1.01 in. (25.7 mm)</p> </div> </div> <p><b>Note:</b></p> <ol style="list-style-type: none"> <li>1. Each section of channel includes <b>3 mounting clips</b>.</li> <li>2. <b>Magnetic mounting</b> option available (see page 2)</li> <li>3. <b>Exterior channel applications</b> should be securely attached to the mounting surface with appropriate screws and/or liquid nails. Acolyte strongly recommends field assembly for exterior applications. Use mounting clips for interior applications only.</li> </ol>

Acolyte does not warrant or represent that the information is free from errors or omission. The information may change without notice and Acolyte is not in any way liable for the accuracy of any information printed and stored or in any way interpreted or used.

**SPECIFICATIONS**

<b>Beam Angle</b>	110°
<b>Lens Type</b>	Clear Lens, Frosted Lens, Milky Lens
<b>Length</b>	Channel is sold by the foot and cut to your exact desired length. Required amount of mounting clips included.
<b>Operating Voltage</b>	24 V
<b>Dimming</b>	MLV / 0-10 Volt / ELV / DALI / DMX
<b>Operating Temperature</b>	-40 — 158 °F (-40 — 70 °C)
<b>Colors</b>	1800K, 2000K, 2200K, 2400K, 2700K, 3000K, 3500K, 4000K, 6000K, Red, Amber, Green, Blue, RGBA, RGBW, RGBWW, VW, Warm Dim, RGBW Addressable (1800K, 2000K, 2200K only available in IP20), Pixel RGB (IP20 only), RGBW Addressable (IP67 only)
<b>CRI</b>	90+ CRI (Static white only)
<b>Lifetime (L70 reported)</b>	50,000 hours
<b>MacAdam ellipse (SDCM)</b>	1-Step Binning (For Static White LEDs only)
<b>Certifications</b>	UL Listed UL 2108 Issued: 2004/02/27 Ed: 1 Rev: 2014/02/24 Low Voltage Lighting Systems CSA C22.2#9.0 Issued: 1996/06/01 Ed: 1 (R2011) General Requirements for Luminaires; with Gen. Inst. 1: 1997, Gen Inst. 2: 1998. ROHS compliant

**ACCESSORIES**

<p><b>Tiltable Stand (Part #: TILTSTANDST)</b></p> <p>Assembled Height with Channel: 1.22 in. (31 mm)</p>	<p><b>End Caps (Included Accessory)</b></p> <p>Material: ABS</p> <p>End Cap without hole</p> <p>End Cap with hole</p>
---	---

<p><b>Magnetic Mount (Part #: CHMAG0.5)</b></p>			<p><b>Features:</b></p> <ul style="list-style-type: none"> <li>- High-energy neodymium magnets come attached to mounting clips with countersink hex nuts</li> <li>- Create easy-mount magnetic channels with minimal surface gaps; no tools or drilling necessary</li> <li>- Magnets rated for 8 lbs. of pull force with static load</li> </ul> <p><b>Applications:</b></p> <ul style="list-style-type: none"> <li>- Industrial lighting retrofits for troffers and other metal fixtures</li> <li>- Metal retail shelf lighting</li> <li>- Temporary light fixture installations</li> </ul>
---	--	--	---

Acolyte does not warrant or represent that the information is free from errors or omission. The information may change without notice and Acolyte is not in any way liable for the accuracy of any information printed and stored or in any way interpreted or used.

ORDERING GUIDE

**STEP 1 Complete Channel Part Number**

CHANNEL	LENS	HOUSING COLOR
<b>CHAS6</b>		
CHAS6 - AS6 Channel	C - Clear Lens*    M - Milky Lens F - Frosted Lens    * Clear lens is the default option if not specified.	SV - Silver (default)    WH - White BK - Black Consult factory for custom colors

**STEP 2 Complete RibbonLyte Part Number**

CATEGORY	CRI	RIBBON TYPE & IP RATING
<b>RB</b>		
RB - RibbonLyte	0 - Static Color, Color Changing 90 - 90+ CRI Static White	SWS220 - Static White Series 2 IP20    LINEA20 - Linea RibbonLyte IP20    VWS220 - VW Series 2 IP20 SWS265 - Static White Series 2 IP65    RGBWS220 - RGBW Series 2 IP20    VWS265 - VW Series 2 IP65 SWS268 - Static White Series 2 IP68    RGBWS265 - RGBW Series 2 IP65    VWS268 - VW Series 2 IP68 SCS220 - Static Color Series 2 IP20    RGBWS268 - RGBW Series 2 IP68    WD20 - Warm Dim IP20 SCS265 - Static Color Series 2 IP65    RGBWW20 - RGBWW 5-in-1 IP20    WD65 - Warm Dim IP65 SCS268 - Static Color Series 2 IP68    RGBWADD - Addressable RGBW    WD68 - Warm Dim IP68 XACTA20 - Xacta RibbonLyte IP20    RGBADD - Pixel RGB IP20

**NOTE:** To ensure waterproofing standards are met, IP65 and IP68 RibbonLyte can NOT be cut in the field.

WATTAGE	COLOR
0.75 - 0.75 W/ft (2.46 W/m - Static White, Static Color)	18 - 1800K    RGB27 - Red, Green, Blue + 2700K
1.0 - 1.0 W/ft (3.3 W/m - Variable White)	20 - 2000K    RGB30 - Red, Green, Blue + 3000K
1.5 - 1.5 W/ft (4.9 W/m - Static White, Static Color, Variable White)	22 - 2200K    RGB40 - Red, Green, Blue + 4000K
2.2 - 2.2 W/ft (7.2 W/m - Static White, Static Color)	24 - 2400K    RGB2465 - Red, Green, Blue + 2400K + 6500K
2.4 - 2.4 W/ft (8 W/m - Static White Linea)	27 - 2700K    RGBA - Red, Green, Blue + Amber
3.0 - 3.0 W/ft (9.8 W/m - Static White, Static Color, Variable White)	30 - 3000K    RGBW30 - RGB + 3000K Addressable
4.3 - 4.3 W/ft (14 W/m - Static White Linea)	35 - 3500K    RGBW40 - RGB + 4000K Addressable
4.4 - 4.4 W/ft (14.4 W/m - Static White, Static Color, RGBW, RGBWW, RGBA)	40 - 4000K    RGBW60 - RGB + 6000K Addressable
4.5 - 4.5 W/ft (14.8 W/m - Static White, Variable White)	60 - 6000K    RGBS - Pixel RGB (SPI)
5.0 - 5.0 W/ft (16.4 W/m - Static White, Static Color)	R - Red    VW - Variable White
5.2 - 5.2 W/ft (17.1 W/m - Warm Dim)	A - Amber    2920 - Warm Dim 2900K - 2000K (IP20)
5.3 - 5.3 W/ft (17.5 W/m - Pixel RGB)	G - Green    2721 - Warm Dim 2700K - 2100K (IP65+IP68)
5.5 - 5.5 W/ft (18.0 W/m - RGBW, RGBA)	B - Blue    Z - Undecided**
6.0 - 6.0 W/ft (19.7 W/m - Static White, Static Color, Variable White, RGBW Addressable)	
6.1 - 6.1 W/ft (20 W/m - Variable White Linea)	
8.8 - 8.8 W/ft (28.9 W/m - RGBW, RGBWW)	

CONNECTION OPTIONS (See diagrams on the right)    Custom Length (ft.)

1 - End Feed Bare Wire Connection	4 - End Feed with IP67 Male Coupler
2 - Back Feed Bare Wire Connection	5 - Soldered Daisy Chain
3 - Side Feed Bare Wire Connection	6 - Daisy Chain With IP67 Couplers

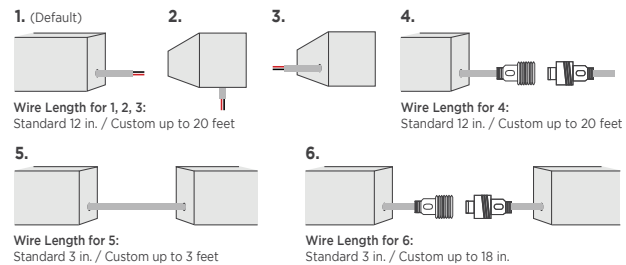

**STEP 3 Complete Assembly Option & Length**

ASSEMBLY OPTION	LENGTH (Standard factory assembled length up to 6 ft 6.7 in. / 2 m)
FI - Field Assembly	
FA - Factory Assembly* (not recommended for exterior applications)	

\* Factory assembled runs exceeding 6 ft 6.7 in. (2 m) will be split into multiple daisy chained fixtures.

**STEP 4 Add Accessories**

ACCESSORIES
TILTSTANDST - Tilttable Stand    CHMAGO.5 - Magnetic Mount

**DO NOT BUTT END CAPS AGAINST EACH OTHER WHEN CREATING LONGER FIXTURES**  
Acolyte STRONGLY SUGGESTS field assembly (without using interior end caps) for direct-view fixtures of more than 6 ft 6.7 in. (2 m) in length. Field assembly without interior end caps will eliminate gaps or dead spots that can be caused by butting interior end caps against each other.

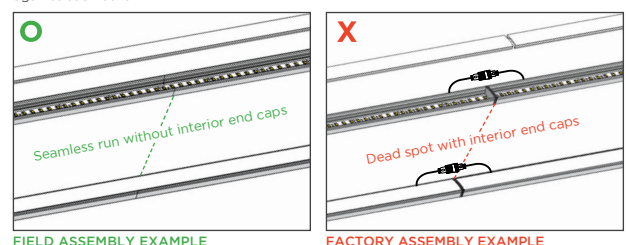

RIBBONLYTE SPECIFICATIONS & COMPATIBILITY

Available Wattages	Cutttable Length	LED Pitch	Color Temp.	lm/W without Lens	Delivered Lumens with Clear Lens		Delivered Lumens with Frosted Lens		Delivered Lumens with Milky Lens		Max Length	Compatible with Channel		
					lm/ft	lm/m	lm/ft	lm/m	lm/ft	lm/m		IP20	IP65	IP68
0.75 Static White Series 2	1.97 in. (50 mm)	48 LEDs/ft (160 LEDs/m)	1800K	84	58	190.3	53.6	175.8	44.1	144.6	IP20: 49 ft (15 m) IP65/ IP68: 32.8 ft (10 m)	✓	✓	✓
			2000K	99	68.3	224	63.1	207	52	170.6				
			2200K	109	75.2	246.7	69.5	228	57.2	187.6				
			2400K	113	78	255.8	72	236.2	59.3	194.5				
			2700K	123	84.9	278.5	78.4	257.2	64.6	211.9				
			3000K	123	84.9	278.5	78.4	257.2	64.6	211.9				
			3500K	130	89.7	294.2	82.9	272	68.3	224				
			4000K	134	92.5	303.4	85.4	80.1	70.4	230.9				
			6000K	131	90.4	296.5	83.5	273.9	68.8	225.7				
1.5 Static White Series 2	1.97 in. (50 mm)	48 LEDs/ft (160 LEDs/m)	1800K	84	115.9	380.2	107.1	351.3	88.2	289.3	IP20: 49 ft (15 m) IP65/ IP68: 32.8 ft (10 m)	✓	✓	✓
			2000K	98	135.2	443.5	125	410	102.9	337.5				
			2200K	109	150.4	493.3	139	455.9	114.5	375.6				
			2400K	113	155.9	511.4	144.1	472.6	118.7	389.3				
			2700K	123	169.7	556.6	156.8	514.3	129.2	423.8				
			3000K	123	169.7	556.6	156.8	514.3	129.2	423.8				
			3500K	129	178	583.8	164.5	539.6	135.5	444.4				
			4000K	134	184.9	606.5	170.9	560.6	140.7	461.5				
			6000K	131	180.8	593	167	547.8	137.6	451.3				
2.2 Static White Series 2	1.97 in. (50 mm)	48 LEDs/ft (160 LEDs/m)	1800K	83	168	551	155.2	509.1	127.8	419.2	IP20: 42 ft (12.8 m) IP65/ IP68: 32.8 ft (10 m)	✓	✓	✓
			2000K	96	194.3	637.3	179.5	588.8	147.8	484.8				
			2200K	106	214.5	703.6	198.2	650.1	163.2	535.3				
			2400K	111	224.7	737	207.6	680.9	170.9	560.6				
			2700K	120	242.9	796.7	224.4	736	184.8	606.1				
			3000K	122	246.9	809.8	228.1	748.2	187.9	616.3				
			3500K	127	257	843	237.5	779	195.6	641.6				
			4000K	133	269.2	883	248.7	779	204.8	671.7				
			6000K	128	259.1	849.8	239.4	785.2	197.1	646.5				
3.0 Static White Series 2	1.97 in. (50 mm)	48 LEDs/ft (160 LEDs/m)	2400K	109.8	303.1	994.1	280.1	918.6	230.6	756.5	IP20: 36 ft (11 m) IP65/ IP68: 32.8 ft (10 m)	✓	✓	✓
			2700K	122.9	339.6	1114	313.5	1028.1	258.1	846.7				
			3000K	130	359.1	1177.9	331.4	1087.1	273	895.3				
			3500K	133	367.5	1205.3	339.2	1112.4	279.3	916.1				
			4000K	133	367.5	1205.3	339.2	1112.4	279.3	916.1				
			6000K	127	350.8	1150.5	323.7	1061.8	266.6	874.5				
4.4 Static White Series 2	1.97 in. (50 mm)	48 LEDs/ft (160 LEDs/m)	2400K	109	441.2	1447	407.7	1337.1	335.7	1101.2	28 ft 4 in. (8.64 m)	✓	✓	✓
			2700K	122	494.4	1621.6	456.3	1496.6	375.8	1232.5				
			3000K	129	522.8	1714.7	482.5	1582.5	397.3	1303.2				
			3500K	132	534.9	1754.5	493.7	1619.3	406.6	1333.5				
			4000K	132	534.9	1754.5	493.7	1619.3	406.6	1333.5				
			6000K	126	510.6	1674.8	471.2	1545.7	388.1	1272.9				
5.0 Static White Series 2	1.4 in. (35.7 mm)	68 LEDs/ft (224 LEDs/m)	2400K	109.8	505.1	1656.8	466.8	1531	384.4	1260.8	IP20: 33 ft 4 in. (10.1 m) IP65/ IP68: 32.8 ft (10 m)	✓	✓	✓
			2700K	122.9	566.1	1856.7	522.4	1713.6	430.2	1411.2				
			3000K	130	598.5	1963.2	552.4	1811.9	454.9	1492.1				
			3500K	133	612.5	2008.9	565.3	1854	465.5	1526.8				
			4000K	133	612.5	2008.9	565.3	1854	465.5	1526.8				
			6000K	127	584.6	1917.6	539.6	1769.7	444.3	1457.4				
6.0 Static White Series 2	1.4 in. (35.7 mm)	68 LEDs/ft (224 LEDs/m)	2400K	109	601.6	1973.2	555.9	1823.4	457.8	1501.6	28 ft (8.5 m)	✓	✓	✓
			2700K	122	674.2	2211.3	622.2	2040.8	512.4	1680.7				
			3000K	129	712.9	2338.2	657.9	2157.9	541.8	1777.1				
			3500K	132	729.4	2392.5	673.2	2208.1	554.4	1818.4				
			4000K	132	729.4	2392.5	673.2	2208.1	554.4	1818.4				
			6000K	126	696.3	2283.8	642.6	2107.7	529.2	1735.8				

**RIBBONLYTE SPECIFICATIONS & COMPATIBILITY**

Available Wattages	Cuttable Length	LED Pitch	Color Temp.	lm/W without Lens	Delivered Lumens with Clear Lens		Delivered Lumens with Frosted Lens		Delivered Lumens with Milky Lens		Max Length	Compatible with Channel		
					lm/ft	lm/m	lm/ft	lm/m	lm/ft	lm/m		IP20	IP65	IP68
0.75 Static Color Series 2	1.97 in. (50 mm)	48 LEDs/ft (160 LEDs/m)	Red	41	28	93	26	86	22	70.6	IP20: 49 ft (15 m) IP65/IP68: 32.8 ft (10 m)	✓	✓	✓
			Green	175	121	396	112	366	92	301.4				
			Blue	19	13	43	12	40	10	32.7				
			Amber	34	23	77	22	71	18	58.6				
1.5 Static Color Series 2	1.97 in. (50 mm)	48 LEDs/ft (160 LEDs/m)	Red	42	58	190	54	176	44	144.7	IP20: 49 ft (15 m) IP65/IP68: 32.8 ft (10 m)	✓	✓	✓
			Green	160	221	724	204	669	168	551.1				
			Blue	18	25	81	23	75	19	62				
			Amber	34	47	154	43	142	36	117.1				
2.2 Static Color Series 2	1.97 in. (50 mm)	48 LEDs/ft (160 LEDs/m)	Red	42	85	279	79	258	65	212.2	IP20: 42 ft (12.8 m) IP65/IP68: 32.8 ft (10 m)	✓	✓	✓
			Green	145	293	963	271	889	223	732.4				
			Blue	18	36	119	34	110	28	90.9				
			Amber	33	67	219	62	202	51	166.7				
3.0 Static Color Series 2	1.97 in. (50 mm)	48 LEDs/ft (160 LEDs/m)	Red	40	110.4	362.1	102	334.6	84	275.52	32.8 ft (10 m)	✓	✓	✓
			Green	127	350.9	1151	323.9	1062.2	266.7	874.78				
			Blue	25	69.1	226.6	63.8	209.1	52.5	172.2				
			Amber	29	80.1	262.8	74	242.6	60.9	199.75				
4.4 Static Color Series 2	1.97 in. (50 mm)	48 LEDs/ft (160 LEDs/m)	Red	38	153.8	504.5	142.1	466.2	117	383.89	29 ft (8.8 m)	✓	✓	✓
			Green	117	474.1	1555.1	437.6	1435.3	360.4	1181.98				
			Blue	24	97.3	319	89.8	294.4	73.9	242.46				
			Amber	25	101.3	332.2	93.5	306.7	77	252.56				
5.0 Static Color Series 2	1.4 in. (35.7 mm)	68 LEDs/ft (224 LEDs/m)	Red	37	170.2	558.2	157.3	515.8	129.5	424.76	30 ft (9.14 m)	✓	✓	✓
			Green	116	534.2	1752.1	493	1617	406	1331.68				
			Blue	24	110.5	362.5	102	334.6	84	275.52				
			Amber	26	119.7	392.7	110.5	362.4	91	298.48				
6.0 Static Color Series 2	1.4 in. (35.7 mm)	68 LEDs/ft (224 LEDs/m)	Red	37	204.2	669.8	188.7	618.9	155.4	509.712	28 ft (8.5 m)	✓	✓	✓
			Green	113	624.4	2048.2	576.3	1890.3	474.6	1556.69				
			Blue	23	127.1	416.9	117.3	384.8	96.6	316.9				
			Amber	24	132.6	435	122.4	401.6	100.8	330.7				
2.4 Static White Linea	1.97 in. (50 mm)	146 LEDs/ft (480 LEDs/m)	2700K	67	148.1	485.8	136.9	448.8	112.7	369.6	21.3 ft (6.5 m)	✓	N/A	N/A
			3000K	71	156.4	514.3	144.5	475.2	119	391.3				
			3500K	83	183.1	601.7	169.2	555.9	139.3	457.8				
			4000K	83	183.1	601.7	169.2	555.9	139.3	457.8				
3.0 Static White Linea	1.97 in. (50 mm)	146 LEDs/ft (480 LEDs/m)	2700K	66	182.2	598	168.3	552.5	138.6	455	21.3 ft (6.5 m)	✓	N/A	N/A
			3000K	73	201.5	661.5	186.2	611.2	153.3	503.3				
			3500K	78	215.3	706.6	198.9	652.8	163.8	537.6				
			4000K	83	229.1	751.6	211.7	694.5	174.3	571.9				
4.3 Static White Linea	1.97 in. (50 mm)	146 LEDs/ft (480 LEDs/m)	2700K	75	297.2	973.4	274.6	899.3	226.1	740.6	24.6 ft (7.5 m)	✓	N/A	N/A
			3000K	78	308.2	1012	284.8	935	234.5	770				
			3500K	86	340.4 lm/ft	1116.9	314.5	1031.9	259	849.8				
			4000K	86	340.4	1116.9	314.5	1031.9	259	849.8				
6.1 Variable White Linea	1.09 in. (27.78 mm)	175 LEDs/ft (576 LEDs/m)	2700K + 6500K	95	533.6	1750.8	493	1617.6	406	1332.1	16.4 ft (5 m)	✓	N/A	N/A

**RIBBONLYTE SPECIFICATIONS & COMPATIBILITY**

Available Wattages	Cuttable Length	LED Pitch	Color Temp.	lm/W without Lens	Delivered Lumens with Clear Lens		Delivered Lumens with Frosted Lens		Delivered Lumens with Milky Lens		Max Length	Compatible with Channel		
					lm/ft	lm/m	lm/ft	lm/m	lm/ft	lm/m		IP20	IP65	IP68
1.5 Static White Xacta	0.2 in. (5 mm)	61 LEDs/ft (200 LEDs/m)	1800K	71	110.2	361.6	101.8	334.1	83.9	275.1	32.74 ft (9.98 m)	✓	n/a	n/a
			2000K	84	130.1	426.8	120.2	394.3	99	324.7				
			2200K	92	142.7	468.3	131.9	432.6	108.6	356.3				
			2400K	96	148.2	486.1	136.9	449.1	112.7	369.8				
			2700K	109	168	551.3	155.3	509.3	127.9	419.4				
			3000K	113	175.3	575	161.9	531.2	133.4	437.5				
			3500K	117	180.7	592.8	166.9	547.7	137.5	451				
			4000K	115	177.1	580.9	163.6	536.7	134.7	442				
			6000K	112	173.5	569	160.3	525.7	132	433				
3.0 Static White Xacta	0.2 in. (5 mm)	61 LEDs/ft (200 LEDs/m)	1800K	71	196.3	643.9	181.3	594.9	149.3	489.9	23.62 ft (7.2 m)	✓	n/a	n/a
			2000K	84	231.6	760	214	702.2	176.2	578.3				
			2200K	92	254.2	833.9	234.8	770.5	193.4	634.5				
			2400K	95	263.8	865.6	243.7	799.7	200.7	658.6				
			2700K	108	299.2	981.7	276.4	907	227.7	747				
			3000K	113	312.1	1023.9	288.3	946	237.4	779.1				
			3500K	116	321.7	1055.6	297.2	975.3	244.8	803.2				
			4000K	114	315.3	1034.5	291.3	955.8	239.9	787.1				
			6000K	111	308.9	1013.4	285.4	936.3	235	771.1				
4.5 Static White Xacta	0.2 in. (5 mm)	61 LEDs/ft (200 LEDs/m)	1800K	72	299.6	983	276.8	908.2	228	747.9	19.03 ft (5.8 m)	✓	n/a	n/a
			2000K	85	353.7	1160.3	326.7	1072	269.1	882.8				
			2200K	93	388	1273.1	358.5	1176.2	295.2	968.6				
			2400K	97	402.8	1321.4	372.1	1220.9	306.5	1005.4				
			2700K	110	456.8	1498.7	422	1384.6	347.6	1140.3				
			3000K	114	476.5	1563.1	440.2	1444.2	362.5	1189.3				
			3500K	118	491.2	1611.5	453.8	1488.9	373.7	1226.1				
			4000K	116	481.4	1579.2	444.7	1459.1	366.3	1201.6				
			6000K	113	471.5	1547	435.7	1429.3	358.8	1177.1				
1.5 Variable White Xacta	0.2 in. (5 mm)	122 LEDs/ft (400 LEDs/m)	2400K + 6000K	138	189.1	620.4	174.7	573.2	143.9	472	32.15 ft (9.8 m)	✓	n/a	n/a
3.0 Variable White Xacta	0.2 in. (5 mm)	122 LEDs/ft (400 LEDs/m)	2400K + 6000K	136	371.1	1217.7	342.9	1125.1	282.4	926.5	22.31 ft (6.8 m)	✓	n/a	n/a
4.5 Variable White Xacta	0.2 in. (5 mm)	122 LEDs/ft (400 LEDs/m)	2400K + 6000K	134	524.2	1719.8	484.3	1588.9	398.9	1308.5	19.03 ft (5.8 m)	✓	n/a	n/a
1.0 Variable White Series 2	1.97 in. (50 mm)	42 LEDs/ft (140 LEDs/m)	2000K + 6500K	85	78.2	257	72.3	237	60	200	32.8 ft (10 m)	✓	✓	✓
3.0 Variable White Series 2	1.97 in. (50 mm)	42 LEDs/ft (140 LEDs/m)	2000K + 6500K	80	220.8	725	205	670	168	551.2	32.8 ft (10 m)	✓	✓	✓
6.0 Variable White Series 2	1.97 in. (50 mm)	42 LEDs/ft (140 LEDs/m)	2000K + 6500K	75	415	1362	382.5	1255	315	1033.5	19 ft 8 in. (6 m)	✓	✓	✓
4.4 RGB Series 2	1.97 in. (50 mm)	36 LEDs/ft (120 LEDs/m)	RGBW (all on)	45	188.1	617.2	168.3	552.2	148.5	487.2	19 ft 8 in. (6 m)	✓	N/A	N/A
5.5 RGB Series 2	1.97 in. (50 mm)	36 LEDs/ft (120 LEDs/m)	RGBW (all on)	59	308.8	1013	275.8	904.9	243.3	798.5	16 ft 4 in. (5 m)	N/A	✓	✓
8.8 RGB Series 2	1.97 in. (50 mm)	36 LEDs/ft (120 LEDs/m)	RGBW (all on)	61	510.2	1673.8	456.3	1497.1	402.6	1320.9	16 ft 4 in. (5 m)	✓	N/A	N/A
4.4 5-in-1 RGBWW	2.46 in. (62.5 mm)	29 LED/ft (96 LED/m)	RGBWW (all on)	59	241.4	792.1	220.7	724	194.7	638.8	16 ft 4 in (5 m)	✓	N/A	N/A
8.8 5-in-1 RGBWW	2.46 in. (62.5 mm)	29 LED/ft (96 LED/m)	RGBWW	50	409.2	1342.6	374	1227.1	330	1082.7	11 ft 6 in (3.5 m)	✓	N/A	N/A
RGBW Addressable	3.94 in. (100 mm)	18 LEDs/ft (60 LEDs/m)	Red	33.5	30.8	101.2	28.5	93.5	23.5	77.1	16 ft 5.64 in. (5.02 m)	N/A	N/A	✓ IP67
			Green	82	75.4	247.5	69.7	228.7	57.4	188.3				
			Blue	15.5	14.2	46.7	13.2	43.2	10.8	35.6				
			White	103	94.8	310.9	87.6	287.3	72.1	236.6				
			All	40	222.8	730.8	205.8	675.2	169.5	556.1				
5.3 Pixel RGB	3.94 in. (100 mm)	18 LEDs/ft (60 LEDs/m)	RGB (all on)	21	114.54	375.36	105.83	346.8	87.15	285.6	24 ft 7.2 in. (7.5 m)	✓	n/a	n/a
5.2 Warm Dim	3.94 in. (100 mm)	36 LEDs/ft (120 LEDs/m)	WARM DIM	55	263.1	863	244.8	803.25	201.6	661.5	16 ft 4 in. (5 m)	✓	✓	✓

**DIODE VISIBILITY CHART** (Data below applies to installations with Milky lens only)

No Visible Diode = N				With Visible Diode = Y										
Note: Linea RibbonLyte has no visible diode														
Static White & Static Color Series 2 0.75/1.5/2.2/3.0/4.4/5.0/6.0		Static White & Static Color Xacta 1.5/3.0/4.5		RGBW & RGBA Series 2 4.4/8.8		5-in-1 RGBWW 4.4		5-in-1 RGBWW 8.8		Pixel RGB 5.3	RGBW Addressable 6.0	Variable White Series 2 1.0/3.0/6.0		Warm Dim 5.2
IP20/IP65/IP68		IP20		IP20 IP65/IP68		IP20		IP20		IP20	IP67	IP20/IP65/IP68		IP20/IP65/IP68
N		N		N		Y		Y		Y	Y	N		N

AVAILABLE DRIVERS / CONTROLLERS AND DIMMING OPTIONS / WIRE GAUGE CHART

NON-DIMMING ELECTRONIC DRIVERS			0-10V/ELV/MLV 3-IN-1		ELV	0-10V VW/WD	
<b>30W, 60W, 96W Non-Dimming Electronic Class 2 Drivers</b> Part No.: • DRVW2430 (30 W) • DRVW2460 (60 W) • DRVW2496 (96 W) 24 VDC 120-277 VAC IP65, dry/damp locations UL Listed	<b>240W, 320W Non-Dimming Electronic Drivers</b> Part No.: • DRVW24240 (240 W) • DRVW24320 (320 W) 24 VDC 90-305 VAC IP65, dry/damp locations UL Recognized	<b>60W, 96W Non-Dimming Compact Drivers</b> Part No.: • DRV2460C (60 W) • DRV2496C (96 W) 24 VDC 120-277 VAC IP20, dry locations UL Class P	<b>60W, 96W, 288W 0-10V/ELV/MLV 3-in-1 Dimmable Drivers</b> Part No.: • DRVW2460TRI010 (60 W) • DRVW2496TRI010 (96 W) • DRVW24288TRI010 (288 W) 24 VDC 120-277 VAC IP65, dry/damp/wet locations UL Listed		<b>60W Dimmable Driver</b> Part No.: • DRVW2460ELV 24 VDC 100-130 VAC Fits in single-gang switch boxes IP20, dry locations UL Recognized	<b>0-10V Dimmable 90W VW/WD Driver</b> Part No.: • DRVRFWDVW2490120 24 VDC 100-277 VAC IP23, dry/damp locations UL Listed	
ATHENA WIRELESS COMPATIBLE		CASAMBI COMPATIBLE DRIVERS		DIMMABLE DALI-2 DRIVERS		DIMMABLE DALI-2 DRIVERS	
<b>94W Athena Wireless Compatible Drivers</b> Part No.: • DRVW2494ATH1CH (1 channel) • DRVW2494ATH2CH (2 channel) 24 VDC 100-277 VAC Dry locations UL Listed		<b>100W &amp; 200W Casambi Compatible 4 Channel Drivers</b> Part No.: • DRVW24100CAS4CH (100 W) • DRVW24200CAS4CH (200 W) 24 VDC 100-277 VAC IP66, dry/damp/wet locations UL Listed, CE, RoHS, Bluetooth, CASAMBI		<b>96W DIMMABLE DALI-2 DT6 D4I &amp; DALI-2 DT8 D4I DRIVERS</b> Part No.: • DRVW2496DALI1CH (1 channel) • DRVW2496DALI2CH (2 channel) 24-26 VDC 120-277 VAC IP67, dry/damp/wet locations UL Listed		<b>75W, 150W, 240W DALI-2 Dimmable Drivers</b> Part No.: • DRVW2475DALI1CH (75 W, 1 channel) • DRVW24150DALI1CH (150 W, 1 channel) • DRVW24240DALI1CH (240 W, 1 channel) • DRV24150DALI2CH (150 W, 2 channels) • DRV24150DALI4CH (150 W, 4 channels) 24 VDC 120-277 VAC IP67, damp/wet locations (1-channel drivers only) IP20, dry location (2-channel & 4-channel drivers only) CE, RoHS, SELV	

DMX CONTROLLERS, VARIABLE WHITE DIMMER, WARM DIM DIMMER - FOR COLOR CHANGING FIXTURES

<b>GLASS TOUCH WALL CONTROLLERS</b> Part No.: • AWCRGBWBK • AWCVWBK	<b>1 ZONE WALL CONTROLLER</b> Part No.: DMXCTRLG	<b>5 ZONE WALL CONTROLLER</b> Part No.: DMXCTRL	<b>10 ZONE WALL CONTROLLER</b> Part No.: DMXCTRLD	<b>6 UNIVERSE DMX CONTROLLER</b> Part No.: DMXCTRLDR6U
<b>VARIABLE WHITE DIMMER</b> Part No.: • RFDIMVWWH (White) • RFDIMVWBK (Black)	<b>WARM DIM DIMMER</b> Part No.: • RFDIMWDWH (White) • RFDIMWDBK (Black)	<b>4 CHANNEL WATERPROOF DMX INTERFACE</b> Part No.: DMXINFWLC4D	<b>5 CHANNEL DMX DECODER</b> Part No.: DMXINF5	<b>DMX OPTO SPLITTER</b> Part No.: DMXOS8

Wattages	30		60		96		150		200		240		300		320	
	Feet	Meters	Feet	Meters	Feet	Meters	Feet	Meters	Feet	Meters	Feet	Meters	Feet	Meters	Feet	Meters
24 AWG / 0.25 mm <sup>2</sup>	14	4.27	9	2.74	5.5	1.68	3.75	1.14	2.75	0.84	2.25	0.69	1.75	0.53	1.75	0.53
22 AWG / 0.34 mm <sup>2</sup>	22	6.71	14	4.27	9	2.74	5.75	1.75	4.5	1.37	3.5	1.07	2.75	0.84	2.75	0.84
20 AWG / 0.5 mm <sup>2</sup>	35	10.67	23	7.01	14	4.27	9	2.74	7	2.13	5.75	1.75	4.5	1.37	4.25	1.30
18 AWG / 0.75 mm <sup>2</sup>	56	17.07	37	11.28	23	7.01	15	4.57	11	3.35	9	2.74	7.5	2.29	7	2.13
16 AWG / 1.5 mm <sup>2</sup>	90	27.44	60	18.29	37	11.28	24	7.32	18	5.49	15	4.57	12	3.66	11	3.35
14 AWG / 2.5 mm <sup>2</sup>	142	43.29	95	28.96	59	17.99	38	11.59	28	8.54	23	7.01	19	5.79	17	5.18
12 AWG / 4 mm <sup>2</sup>	226	68.90	151	46.04	94	28.66	60	18.29	45	13.72	37	11.28	30	9.15	28	8.54
10 AWG / 6 mm <sup>2</sup>	360	109.76	240	73.17	150	45.73	96	29.27	72	21.95	60	18.29	48	14.63	45	13.72
8 AWG / 10 mm <sup>2</sup>	574	175.00	381	116.16	239	72.87	153	46.65	115	35.06	95	28.96	76	23.17	71	21.65

WIRING DIAGRAMS - STATIC WHITE / STATIC COLOR / RGBW / RGBA / RGBWW

0-10 V

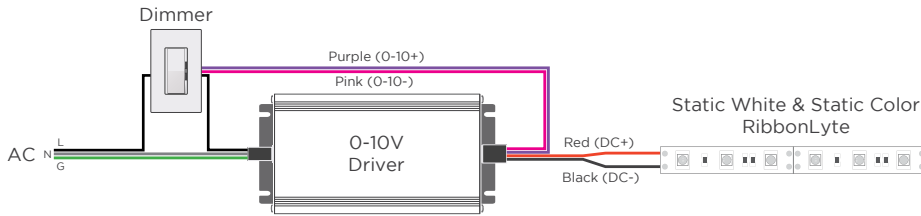

MLV / ELV

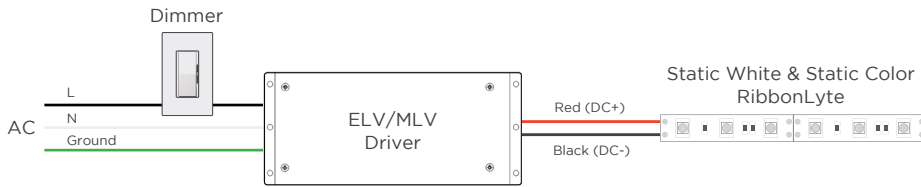

DMX WIRING WITH STATIC WHITE & STATIC COLOR RIBBONLYTE

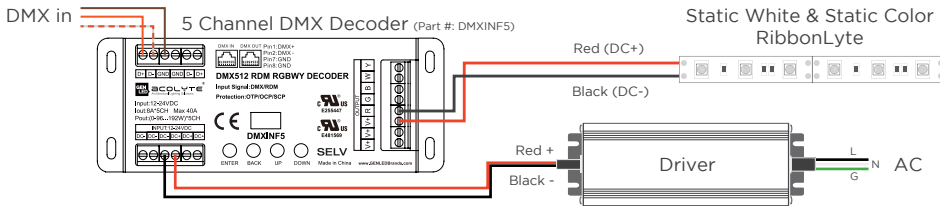

DALI-2 WIRING WITH STATIC WHITE & STATIC COLOR RIBBONLYTE

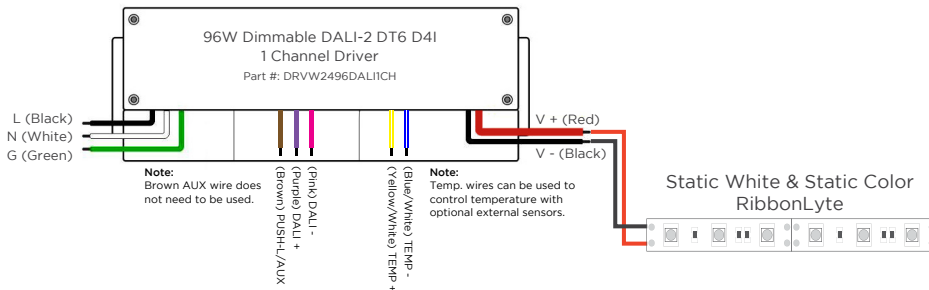

STATIC WHITE & STATIC COLOR RIBBONLYTE WIRING WITH ATHENA WIRELESS COMPATIBLE DRIVER

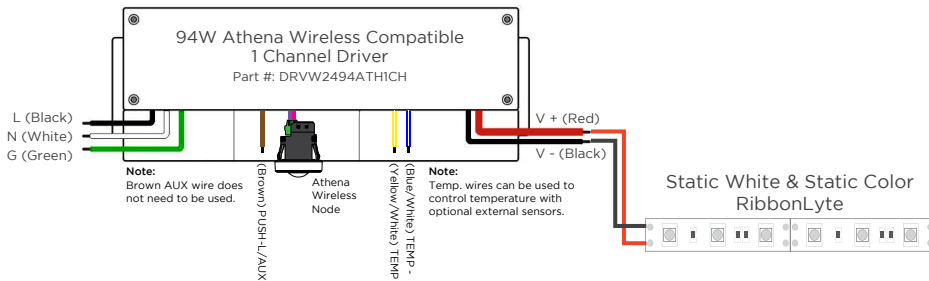

DMX WITH RGBWW 5-IN-1 RIBBONLYTE

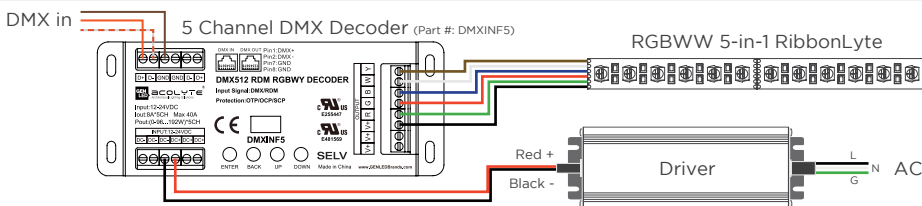

WIRE COLORS PER RIBBONLYTE COLOR

STATIC WHITE + STATIC COLOR

Red Wire (+) Positive  
Black Wire (-) Negative

RGBW + RGBA

Black Wire (+) Positive  
Green Wire (-) goes to Green Channel  
Red Wire (-) goes to Red Channel  
Blue Wire (-) goes to Blue Channel  
White Wire (-) goes to White Channel

RGBWW

Black (+) Positive  
Green Wire (-) goes to Green Channel  
Red Wire (-) goes to Red Channel  
Blue Wire (-) goes to Blue Channel  
White Wire (-) goes to White Channel 1  
Brown Wire (-) goes to White Channel 2

WIRING DIAGRAMS - VARIABLE WHITE

2-CHANNEL VARIABLE WHITE DIMMING

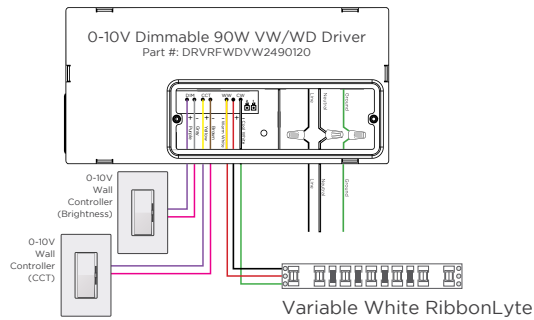

WIRE COLORS PER RIBBONLYTE COLOR

**VARIABLE WHITE**  
Black Wire (+) Positive  
Red Wire (-) goes to Warm White Channel  
Green Wire (-) goes to Cool White Channel

DMX WIRING WITH VARIABLE WHITE RIBBONLYTE

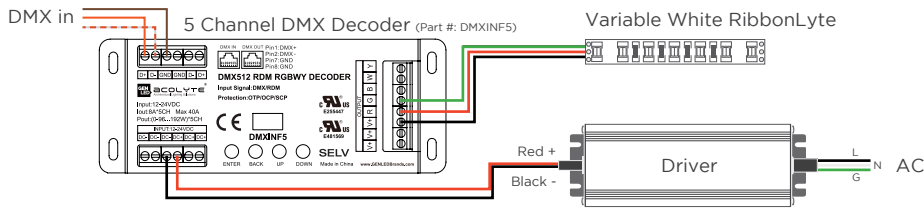

DALI-2 WIRING WITH VARIABLE WHITE RIBBONLYTE

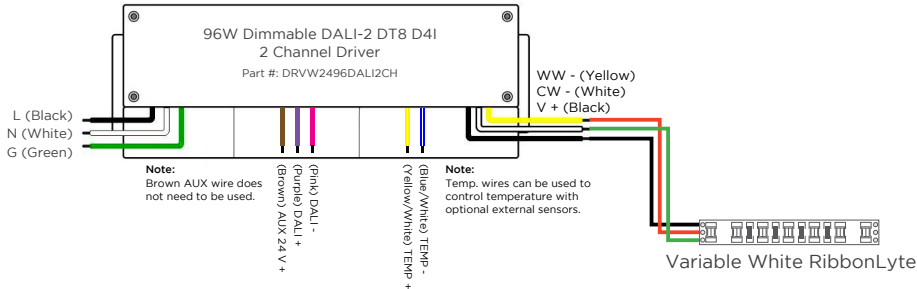

VARIABLE WHITE RIBBONLYTE WIRING WITH ATHENA WIRELESS COMPATIBLE DRIVER

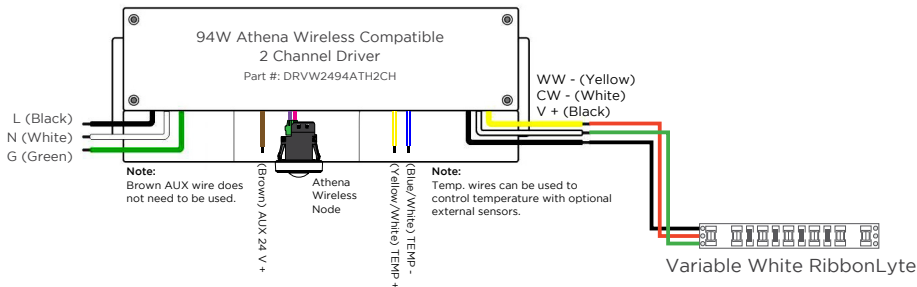

WIRING DIAGRAMS WITH RGBW ADDRESSABLE RIBBONLYTE

One DMX Universe consists of 128 addresses and 512 channels (42 ft, 8 in. of RibbonLyte).

Any single run of RibbonLyte that is less than 16 ft, 4 in. can be wired directly to the controller.

For additional runs, Opto Splitter must be used. Each individual run will need its own Opto Splitter output.

WIRE INDEX	
+	(24V +)
PI	(DMX GND)
A+	(DMX +)
B-	(DMX -)
GND	(24V -)

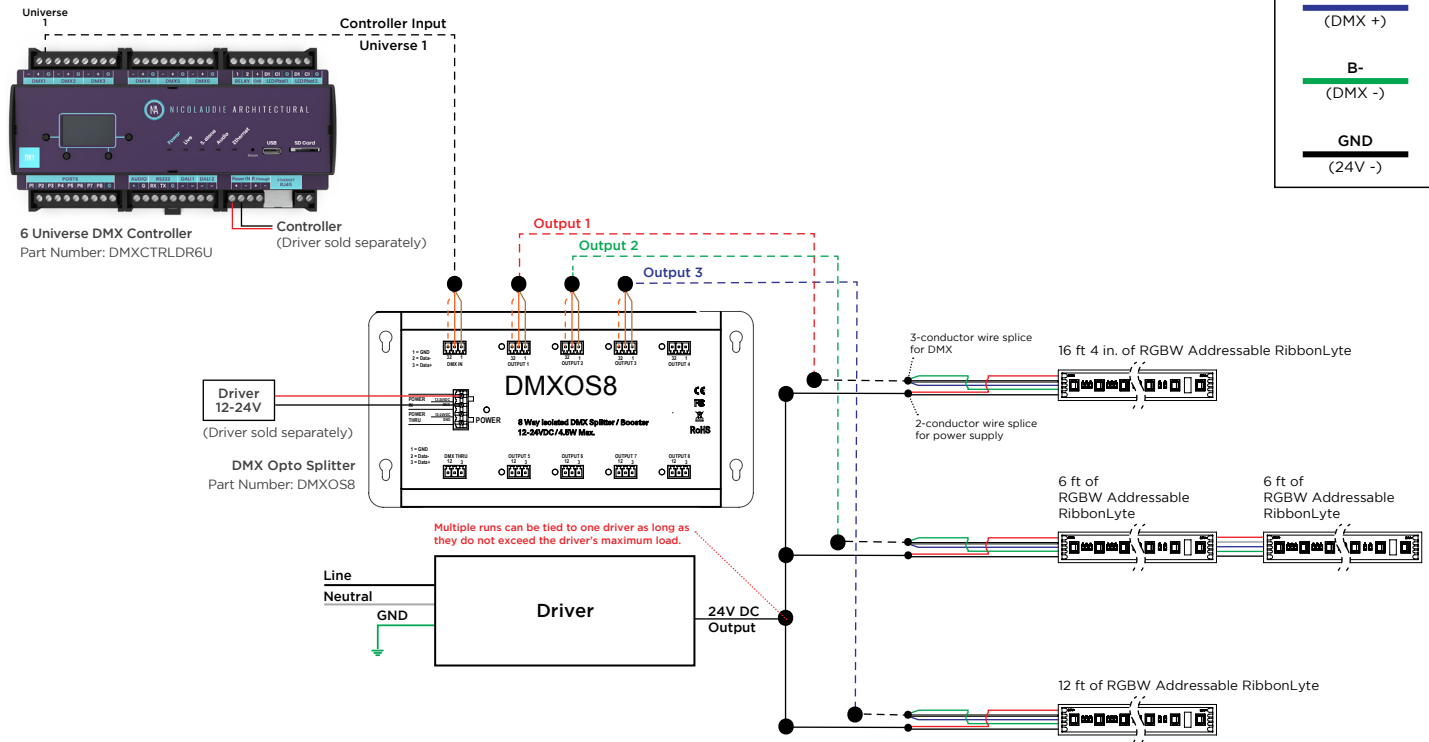

REV.05DEC2025

**GLOBAL HQ**

320 Murray Hill Pkwy  
East Rutherford, NJ 07073  
U.S.  
T: (+1) 212 629 6830  
E: Sales-US@GENLEDBrands.com

**EUROPEAN HQ**

Hogeweyselaan 119  
1382 JK Weesp  
Netherlands  
T: (+31) 346 235 000  
E: SalesEurope@GENLEDBrands.com

**MEINA HQ**

PO Box 371378, #823, Building 4EA  
Dubai Airport Free Zone  
Dubai, UAE  
T: (+971) 4 701 7901  
E: SalesMEINA@genledbrands.com

**ASIA-PACIFIC HQ**

Room 402, Building D  
Shenshi Tongchuang Science and Technology Park  
No. 16 Hongyin Road  
Xingqiang Community, Xihu Street  
Guangming District, Shenzhen, China 518107  
T: (+86) 755 8529 0710  
E: Sales-Pacific@GENLEDBrands.com