

### AS6 CHANNEL FIXTURE

Our AS6 Channel Fixture is a medium width, low profile channel with a 110-degree beam angle ideal for a wide, even spread of light. This channel is ideal for cove and toe kick applications, and can also be used in conjunction with our tiltable stands. The AS6 Channel includes choice of clear, frosted or milky lens. Custom design a fixture with our AS6 Channel and RibbonLyte products.

- Available for field assembly or factory assembly
- Beam Angle 110°
- Wattage Range from 0.75 W/ft (2.46 W/m) to 8.8 W/ft (28.9 W/m)
- Static White delivered lumen range from 44.1 lm/ft (144.6 lm/m) up to 729 lm/ft (2392.5 lm/m)
- Assembled in USA

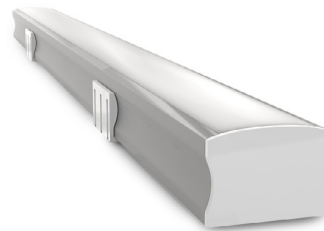

### HOUSING FINISHES

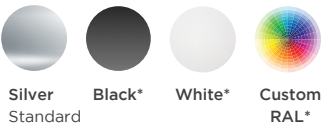

\*Additional fee applies

### AVAILABLE LENS FINISHES

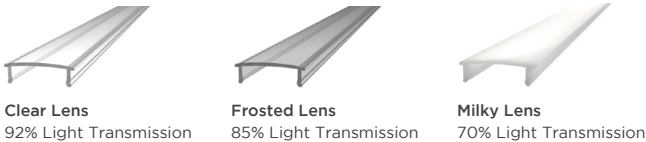

### AVAILABLE COLORS & COLOR TEMPERATURES

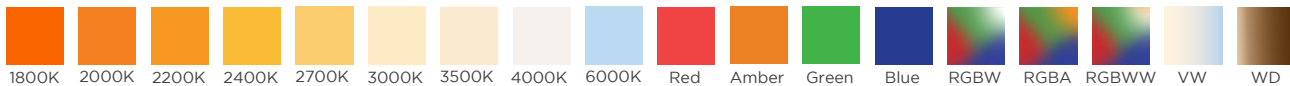

### DIMENSIONS

AS6 Channel	Mounting Clip (Included Accessory)
<p><b>Width:</b> 0.89 in. (22.5 mm)  <b>Height:</b> 0.62 in. (15.7 mm)  <b>Internal Width:</b> 0.71 in. (18 mm)</p>	<p>Material: stainless steel</p> <div style="display: flex; justify-content: space-around;"> <div> <p><b>Side View</b></p> <p><b>Width:</b> 0.36 in. (9.14 mm)  <b>Length:</b> 1.01 in. (25.7 mm)  <b>Height:</b> 0.36 in. (9.14 mm)</p> </div> <div> <p><b>Top View</b></p> <p><b>Width:</b> 0.35 in. (9 mm)  <b>Length:</b> 1.01 in. (25.7 mm)  <b>Hole Diameter:</b> 0.16 in. (4 mm)</p> </div> <div> <p><b>Assembled View</b></p> <p><b>Height:</b> 0.68 in. (17.3 mm)  <b>Width:</b> 1.01 in. (25.7 mm)</p> </div> </div> <p><b>Note:</b></p> <ol style="list-style-type: none"> <li>1. Each section of channel includes <b>3 mounting clips</b>.</li> <li>2. <b>Magnetic mounting</b> option available (see page 2)</li> <li>3. <b>Exterior channel applications</b> should be securely attached to the mounting surface with appropriate screws and/or liquid nails. Acolyte strongly recommends field assembly for exterior applications. Use mounting clips for interior applications only.</li> </ol>

Acolyte does not warrant or represent that the information is free from errors or omission. The information may change without notice and Acolyte is not in any way liable for the accuracy of any information printed and stored or in any way interpreted or used.

**SPECIFICATIONS**

<b>Beam Angle</b>	110°
<b>Lens Type</b>	Clear Lens, Frosted Lens, Milky Lens
<b>Length</b>	Channel is sold by the foot and cut to your exact desired length. Required amount of mounting clips included.
<b>Operating Voltage</b>	24 V
<b>Dimming</b>	MLV / 0-10 Volt / ELV / DALI / DMX
<b>Operating Temperature</b>	-40 – 158 °F (-40 – 70 °C)
<b>Colors</b>	1800K, 2000K, 2200K, 2400K, 2700K, 3000K, 3500K, 4000K, 6000K, Red, Amber, Green, Blue, RGBA, RGBW, RGBWW, VW, Warm Dim, RGBW Addressable (1800K, 2000K, 2200K only available in IP20)
<b>CRI</b>	90+ CRI (Static white only)
<b>Lamp Life</b>	L70 at 50,000 hours
<b>MacAdam ellipse (SDCM)</b>	2-Step Binning (For Static White LEDs only)
<b>Certifications</b>	UL Listed UL 2108 Issued: 2004/02/27 Ed: 1 Rev: 2014/02/24 Low Voltage Lighting Systems CSA C22.2#9.0 Issued: 1996/06/01 Ed: 1 (R2011) General Requirements for Luminaries; with Gen. Inst. 1: 1997, Gen Inst. 2: 1998. ROHS compliant

**ACCESSORIES**

<p><b>Tilttable Stand</b></p> <p>Assembled Height with Channel: 1.22 in. (31 mm)</p>	<p><b>End Caps</b></p> <p>Material: ABS</p>
--	---

**Magnetic Mount (Part #: CHMAG0.5)**

<p><b>Side View</b></p>	<p><b>Top View</b></p>	<p><b>Assembled View</b></p>	<p><b>Features:</b></p> <ul style="list-style-type: none"> <li>- High-energy neodymium magnets come attached to mounting clips with countersink hex nuts</li> <li>- Create easy-mount magnetic channels with minimal surface gaps; no tools or drilling necessary</li> <li>- Magnets rated for 8 lbs. of pull force with static load</li> </ul> <p><b>Applications:</b></p> <ul style="list-style-type: none"> <li>- Industrial lighting retrofits for troffers and other metal fixtures</li> <li>- Metal retail shelf lighting</li> <li>- Temporary light fixture installations</li> </ul>
-------------------------	------------------------	------------------------------	---

Acolyte does not warrant or represent that the information is free from errors or omission. The information may change without notice and Acolyte is not in any way liable for the accuracy of any information printed and stored or in any way interpreted or used.

ORDERING GUIDE

**STEP 1** Complete Channel Part Number

CHANNEL	LENS	HOUSING COLOR
<b>CHAS6</b>		
CHAS6 - AS6 Channel	C - Clear Lens*    M - Milky Lens F - Frosted Lens    * Clear lens is the default option if not specified.	SV - Silver (default)    WH - White BK - Black Consult factory for custom colors

**STEP 2** Complete RibbonLyte Part Number

CATEGORY	CRI	RIBBON TYPE & IP RATING		
<b>RB</b>				
RB - RibbonLyte	0 - Static Color, Color Changing 90 - 90+ CRI Static White	SWS220 - Static White Series 2 IP20 SWS265 - Static White Series 2 IP65 SWS268 - Static White Series 2 IP68 SCS220 - Static Color Series 2 IP20 SCS265 - Static Color Series 2 IP65 SCS268 - Static Color Series 2 IP68	LINEA20 - Linea RibbonLyte IP20 RGBWADD - Addressable RGBW RGBWS220 - RGBW Series 2 IP20 RGBWS265 - RGBW Series 2 IP65 RGBWS268 - RGBW Series 2 IP68 RGBWW20 - RGBWW 5-in-1 IP20	VWS220 - VW Series 2 IP20 VWS265 - VW Series 2 IP65 VWS268 - VW Series 2 IP68 WD20 - Warm Dim IP20 WD65 - Warm Dim IP65 WD68 - Warm Dim IP68

NOTE: To ensure waterproofing standards are met, IP65 and IP68 RibbonLyte can NOT be cut in the field.

WATTAGE	COLOR
0.75 - 0.75 W/ft (2.46 W/m - Static White, Static Color)	18 - 1800K    VW - Variable White
1.0 - 1.0 W/ft (3.3 W/m - Variable White)	20 - 2000K    RGB27 - Red, Green, Blue + 2700K
1.5 - 1.5 W/ft (4.9 W/m - Static White, Static Color)	22 - 2200K    RGB30 - Red, Green, Blue + 3000K
2.2 - 2.2 W/ft (7.2 W/m - Static White, Static Color)	24 - 2400K    RGB40 - Red, Green, Blue + 4000K
2.4 - 2.4 W/ft (8 W/m - Static White Linea)	27 - 2700K    RGB2465 - Red, Green, Blue + 2400K + 6500K
3.0 - 3.0 W/ft (9.8 W/m - Static White, Static Color, Variable White)	30 - 3000K    RGBA - Red, Green, Blue + Amber
4.3 - 4.3 W/ft (14 W/m - Static White Linea)	35 - 3500K    RGBW30 - RGB + 3000K Addressable
4.4 - 4.4 W/ft (14.4 W/m - Static White, Static Color, RGBW, RGBWW, RGBA)	40 - 4000K    RGBW40 - RGB + 4000K Addressable
5.0 - 5.0 W/ft (16.4 W/m - Static White, Static Color)	60 - 6000K    RGBW60 - RGB + 6000K Addressable
5.2 - 5.2 W/ft (17.1 W/m - Warm Dim)	R - Red    2920 - Warm Dim 2900K - 2000K (IP20)
5.5 - 5.5 W/ft (18.0 W/m - RGBW, RGBA)	A - Amber    2721 - Warm Dim 2700K - 2100K (IP65+IP68)
6.0 - 6.0 W/ft (19.7 W/m - Static White, Static Color, Variable White)	G - Green    Z - Undecided**
6.1 - 6.1 W/ft (20 W/m - Variable White Linea)	B - Blue    ** For quotes only. Must be chosen before final order.
8.8 - 8.8 W/ft (28.9 W/m - RGBW, RGBWW)	

CONNECTION OPTIONS (See diagrams on the right)

Custom Length (ft.)	
1 - End Feed Bare Wire Connection	4 - End Feed with IP67 Male Coupler
2 - Back Feed Bare Wire Connection	5 - Soldered Daisy Chain
3 - Side Feed Bare Wire Connection	6 - Daisy Chain With IP67 Couplers

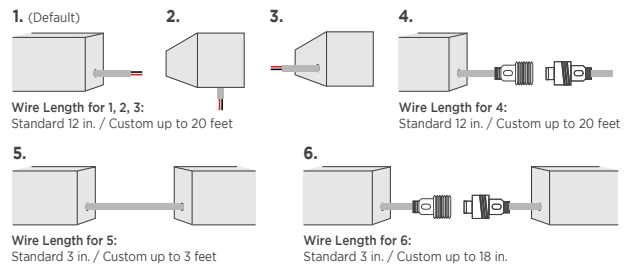

**STEP 3** Complete Assembly Option & Length

ASSEMBLY OPTION	LENGTH (Standard factory assembled length up to 6 ft 6.7 in. / 2 m)
FI - Field Assembly	
FA - Factory Assembly* (not recommended for exterior applications)	

\* Factory assembled runs exceeding 6 ft 6.7 in. (2 m) will be split into multiple daisy chained fixtures.

**STEP 4** Add Accessories

ACCESSORIES	
TILTSTANDST - Tiltable Stand	CHMAGO.5 - Magnetic Mount

DO NOT BUTT END CAPS AGAINST EACH OTHER WHEN CREATING LONGER FIXTURES  
Acolyte STRONGLY SUGGESTS field assembly (without using interior end caps) for direct-view fixtures of more than 6 ft 6.7 in. (2 m) in length. Field assembly without interior end caps will eliminate gaps or dead spots that can be caused by butting interior end caps against each other.

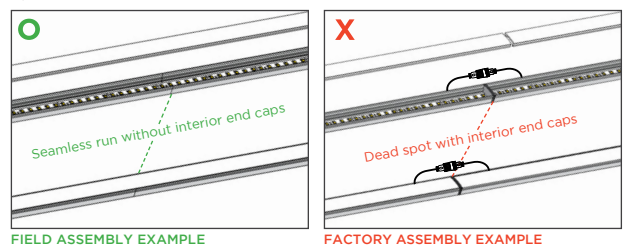



**RIBBONLYTE SPECIFICATIONS & COMPATIBILITY**

Available Wattages	Cuttable Length	LED Pitch	Color Temp.	lm/W without Lens	Delivered Lumens with Clear Lens	Delivered Lumens with Frosted Lens	Delivered Lumens with Milky Lens	Max Length	Compatible with Channel		
									IP20	IP65	IP68
0.75 Static White Series 2	1.97 in. (50 mm)	48 LEDs/ft (160 LEDs/m)	1800K	84	58 lm/ft (190.3 lm/m)	53.6 lm/ft (175.8 lm/m)	44.1 lm/ft (144.6 lm/m)	IP20: 49 ft (15 m) IP65/ IP68: 32.8 ft (10 m)	✓	✓	✓
			2000K	99	68.3 lm/ft (224 lm/m)	63.1 lm/ft (207 lm/m)	52 lm/ft (170.6 lm/m)				
			2200K	109	75.2 lm/ft (246.7 lm/m)	69.5 lm/ft (228 lm/m)	57.2 lm/ft (187.6 lm/m)				
			2400K	113	78 lm/ft (255.8 lm/m)	72.0 lm/ft (236.2 lm/m)	59.3 lm/ft (194.5 lm/m)				
			2700K	123	84.9 lm/ft (278.5 lm/m)	78.4 lm/ft (257.2 lm/m)	64.6 lm/ft (211.9 lm/m)				
			3000K	123	84.9 lm/ft (278.5 lm/m)	78.4 lm/ft (257.2 lm/m)	64.6 lm/ft (211.9 lm/m)				
			3500K	130	89.7 lm/ft (294.2 lm/m)	82.9 lm/ft (272 lm/m)	68.3 lm/ft (224 lm/m)				
			4000K	134	92.5 lm/ft (303.4 lm/m)	85.4 lm/ft (280.1 lm/m)	70.4 lm/ft (230.9 lm/m)				
			6000K	131	90.4 lm/ft (296.5 lm/m)	83.5 lm/ft (273.9 lm/m)	68.8 lm/ft (225.7 lm/m)				
1.5 Static White Series 2	1.97 in. (50 mm)	48 LEDs/ft (160 LEDs/m)	1800K	84	115.9 lm/ft (380.2 lm/m)	107.1 lm/ft (351.3 lm/m)	88.2 lm/ft (289.3 lm/m)	IP20: 49 ft (15 m) IP65/ IP68: 32.8 ft (10 m)	✓	✓	✓
			2000K	98	135.2 lm/ft (443.5 lm/m)	125 lm/ft (410 lm/m)	102.9 lm/ft (337.5 lm/m)				
			2200K	109	150.4 lm/ft (493.3 lm/m)	139 lm/ft (455.9 lm/m)	114.5 lm/ft (375.6 lm/m)				
			2400K	113	155.9 lm/ft (511.4 lm/m)	144.1 lm/ft (472.6 lm/m)	118.7 lm/ft (389.3 lm/m)				
			2700K	123	169.7 lm/ft (556.6 lm/m)	156.8 lm/ft (514.3 lm/m)	129.2 lm/ft (423.8 lm/m)				
			3000K	123	169.7 lm/ft (556.6 lm/m)	156.8 lm/ft (514.3 lm/m)	129.2 lm/ft (423.8 lm/m)				
			3500K	129	178 lm/ft (583.8 lm/m)	164.5 lm/ft (539.6 lm/m)	135.5 lm/ft (444.4 lm/m)				
			4000K	134	184.9 lm/ft (606.5 lm/m)	170.9 lm/ft (560.6 lm/m)	140.7 lm/ft (461.5 lm/m)				
			6000K	131	180.8 lm/ft (593 lm/m)	167 lm/ft (547.8 lm/m)	137.6 lm/ft (451.3 lm/m)				
2.2 Static White Series 2	1.97 in. (50 mm)	48 LEDs/ft (160 LEDs/m)	1800K	83	168 lm/ft (551 lm/m)	155.2 lm/ft (509.1 lm/m)	127.8 lm/ft (419.2 lm/m)	IP20: 42 ft (12.8 m) IP65/ IP68: 32.8 ft (10 m)	✓	✓	✓
			2000K	96	194.3 lm/ft (637.3 lm/m)	179.5 lm/ft (588.8 lm/m)	147.8 lm/ft (484.8 lm/m)				
			2200K	106	214.5 lm/ft (703.6 lm/m)	198.2 lm/ft (650.1 lm/m)	163.2 lm/ft (535.3 lm/m)				
			2400K	111	224.7 lm/ft (737 lm/m)	207.6 lm/ft (680.9 lm/m)	170.9 lm/ft (560.6 lm/m)				
			2700K	120	242.9 lm/ft (796.7 lm/m)	224.4 lm/ft (736 lm/m)	184.8 lm/ft (606.1 lm/m)				
			3000K	122	246.9 lm/ft (809.8 lm/m)	228.1 lm/ft (748.2 lm/m)	187.9 lm/ft (616.3 lm/m)				
			3500K	127	257 lm/ft (843 lm/m)	237.5 lm/ft (779 lm/m)	195.6 lm/ft (641.6 lm/m)				
			4000K	133	269.2 lm/ft (883 lm/m)	248.7 lm/ft (779 lm/m)	204.8 lm/ft (671.7 lm/m)				
			6000K	128	259.1 lm/ft (849.8 lm/m)	239.4 lm/ft (785.2 lm/m)	197.1 lm/ft (646.5 lm/m)				
3.0 Static White Series 2	1.97 in. (50 mm)	48 LEDs/ft (160 LEDs/m)	2400K	109.8	303.1 lm/ft (994.1 lm/m)	280.1 lm/ft (918.6 lm/m)	230.6 lm/ft (756.5 lm/m)	IP20: 36 ft (11 m) IP65/ IP68: 32.8 ft (10 m)	✓	✓	✓
			2700K	122.9	339.6 lm/ft (1114 lm/m)	313.5 lm/ft (1028.1 lm/m)	258.1 lm/ft (846.7 lm/m)				
			3000K	130	359.1 lm/ft (1177.9 lm/m)	331.4 lm/ft (1087.1 lm/m)	273 lm/ft (895.3 lm/m)				
			3500K	133	367.5 lm/ft (1205.3 lm/m)	339.2 lm/ft (1112.4 lm/m)	279.3 lm/ft (916.1 lm/m)				
			4000K	133	367.5 lm/ft (1205.3 lm/m)	339.2 lm/ft (1112.4 lm/m)	279.3 lm/ft (916.1 lm/m)				
			6000K	127	350.8 lm/ft (1150.5 lm/m)	323.7 lm/ft (1061.8 lm/m)	266.6 lm/ft (874.5 lm/m)				
4.4 Static White Series 2	1.97 in. (50 mm)	48 LEDs/ft (160 LEDs/m)	2400K	109	441.2 lm/ft (1447 lm/m)	407.7 lm/ft (1337.1 lm/m)	335.7 lm/ft (1101.2 lm/m)	28 ft 4 in. (8.64 m)	✓	✓	✓
			2700K	122	494.4 lm/ft (1621.6 lm/m)	456.3 lm/ft (1496.6 lm/m)	375.8 lm/ft (1232.5 lm/m)				
			3000K	129	522.8 lm/ft (1714.7 lm/m)	482.5 lm/ft (1582.5 lm/m)	397.3 lm/ft (1303.2 lm/m)				
			3500K	132	534.9 lm/ft (1754.5 lm/m)	493.7 lm/ft (1619.3 lm/m)	406.6 lm/ft (1333.5 lm/m)				
			4000K	132	534.9 lm/ft (1754.5 lm/m)	493.7 lm/ft (1619.3 lm/m)	406.6 lm/ft (1333.5 lm/m)				
6000K	126	510.6 lm/ft (1674.8 lm/m)	471.2 lm/ft (1545.7 lm/m)	388.1 lm/ft (1272.9 lm/m)							
5.0 Static White Series 2	1.4 in. (35.7 mm)	68 LEDs/ft (224 LEDs/m)	2400K	109.8	505.1 lm/ft (1656.8 lm/m)	466.8 lm/ft (1531 lm/m)	384.4 lm/ft (1260.8 lm/m)	IP20: 33 ft 4 in. (10.1 m) IP65/ IP68: 32.8 ft (10 m)	✓	✓	✓
			2700K	122.9	566.1 lm/ft (1856.7 lm/m)	522.4 lm/ft (1713.6 lm/m)	430.2 lm/ft (1411.2 lm/m)				
			3000K	130	598.5 lm/ft (1963.2 lm/m)	552.4 lm/ft (1811.9 lm/m)	454.9 lm/ft (1492.1 lm/m)				
			3500K	133	612.5 lm/ft (2008.9 lm/m)	565.3 lm/ft (1854 lm/m)	465.5 lm/ft (1526.8 lm/m)				
			4000K	133	612.5 lm/ft (2008.9 lm/m)	565.3 lm/ft (1854 lm/m)	465.5 lm/ft (1526.8 lm/m)				
			6000K	127	584.6 lm/ft (1917.6 lm/m)	539.6 lm/ft (1769.7 lm/m)	444.3 lm/ft (1457.4 lm/m)				
6.0 Static White Series 2	1.4 in. (35.7 mm)	68 LEDs/ft (224 LEDs/m)	2400K	109	601.6 lm/ft (1973.2 lm/m)	555.9 lm/ft (1823.4 lm/m)	457.8 lm/ft (1501.6 lm/m)	28 ft (8.5 m)	✓	✓	✓
			2700K	122	674.2 lm/ft (2211.3 lm/m)	622.2 lm/ft (2040.8 lm/m)	512.4 lm/ft (1680.7 lm/m)				
			3000K	129	712.9 lm/ft (2338.2 lm/m)	657.9 lm/ft (2157.9 lm/m)	541.8 lm/ft (1777.1 lm/m)				
			3500K	132	729.4 lm/ft (2392.5 lm/m)	673.2 lm/ft (2208.1 lm/m)	554.4 lm/ft (1818.4 lm/m)				
			4000K	132	729.4 lm/ft (2392.5 lm/m)	673.2 lm/ft (2208.1 lm/m)	554.4 lm/ft (1818.4 lm/m)				
			6000K	126	696.3 lm/ft (2283.8 lm/m)	642.6 lm/ft (2107.7 lm/m)	529.2 lm/ft (1735.8 lm/m)				

**RIBBONLYTE SPECIFICATIONS & COMPATIBILITY**

Available Wattages	Cuttable Length	LED Pitch	Color Temp.	lm/W without Lens	Delivered Lumens with Clear Lens	Delivered Lumens with Frosted Lens	Delivered Lumens with Milky Lens	Max Length	Compatible with Channel		
									IP20	IP65	IP68
0.75 Static Color Series 2	1.97 in. (50 mm)	48 LEDs/ft (160 LEDs/m)	Red	41	28 lm/ft (93 lm/m)	26 lm/ft (86 lm/m)	22 lm/ft (70.6 lm/m)	IP20: 49 ft (15 m) IP65/ IP68: 32.8 ft (10 m)	✓	✓	✓
			Green	175	121 lm/ft (396 lm/m)	112 lm/ft (366 lm/m)	92 lm/ft (301.4 lm/m)				
			Blue	19	13 lm/ft (43 lm/m)	12 lm/ft (40 lm/m)	10 lm/ft (32.7 lm/m)				
			Amber	34	23 lm/ft (77 lm/m)	22 lm/ft (71 lm/m)	18 lm/ft (58.6 lm/m)				
1.5 Static Color Series 2	1.97 in. (50 mm)	48 LEDs/ft (160 LEDs/m)	Red	42	58 lm/ft (190 lm/m)	54 lm/ft (176 lm/m)	44 lm/ft (144.7 lm/m)	IP20: 49 ft (15 m) IP65/ IP68: 32.8 ft (10 m)	✓	✓	✓
			Green	160	221 lm/ft (724 lm/m)	204 lm/ft (669 lm/m)	168 lm/ft (551.1 lm/m)				
			Blue	18	25 lm/ft (81 lm/m)	23 lm/ft (75 lm/m)	19 lm/ft (62 lm/m)				
			Amber	34	47 lm/ft (154 lm/m)	43 lm/ft (142 lm/m)	36 lm/ft (117.1 lm/m)				
2.2 Static Color Series 2	1.97 in. (50 mm)	48 LEDs/ft (160 LEDs/m)	Red	42	85 lm/ft (279 lm/m)	79 lm/ft (258 lm/m)	65 lm/ft (212.2 lm/m)	IP20: 42 ft (12.8 m) IP65/ IP68: 32.8 ft (10 m)	✓	✓	✓
			Green	145	293 lm/ft (963 lm/m)	271 lm/ft (889 lm/m)	223 lm/ft (732.4 lm/m)				
			Blue	18	36 lm/ft (119 lm/m)	34 lm/ft (110 lm/m)	28 lm/ft (90.9 lm/m)				
			Amber	33	67 lm/ft (219 lm/m)	62 lm/ft (202 lm/m)	51 lm/ft (166.7 lm/m)				
3.0 Static Color Series 2	1.97 in. (50 mm)	48 LEDs/ft (160 LEDs/m)	Red	40.0	110.4 lm/ft (362.1 lm/m)	102.0 lm/ft (334.6 lm/m)	84.0 lm/ft (275.52 lm/m)	32.8 ft (10 m)	✓	✓	✓
			Green	127.0	350.9 lm/ft (1151.0 lm/m)	323.9 lm/ft (1062.2 lm/m)	266.7 lm/ft (874.776 lm/m)				
			Blue	25.0	69.1 lm/ft (226.6 lm/m)	63.8 lm/ft (209.1 lm/m)	52.5 lm/ft (172.2 lm/m)				
			Amber	29.0	80.1 lm/ft (262.8 lm/m)	74.0 lm/ft (242.6 lm/m)	60.9 lm/ft (199.752 lm/m)				
4.4 Static Color Series 2	1.97 in. (50 mm)	48 LEDs/ft (160 LEDs/m)	Red	38.0	153.8 lm/ft (504.5 lm/m)	142.1 lm/ft (466.2 lm/m)	117.0 lm/ft (383.8912 lm/m)	29 ft (8.8 m)	✓	✓	✓
			Green	117.0	474.1 lm/ft (1555.1 lm/m)	437.6 lm/ft (1435.3 lm/m)	360.4 lm/ft (1181.981 lm/m)				
			Blue	24.0	97.3 lm/ft (319.0 lm/m)	89.8 lm/ft (294.4 lm/m)	73.9 lm/ft (242.4576 lm/m)				
			Amber	25.0	101.3 lm/ft (332.2 lm/m)	93.5 lm/ft (306.7 lm/m)	77.0 lm/ft (252.56 lm/m)				
5.0 Static Color Series 2	1.4 in. (35.7 mm)	68 LEDs/ft (224 LEDs/m)	Red	37.0	170.2 lm/ft (558.2 lm/m)	157.3 lm/ft (515.8 lm/m)	129.5 lm/ft (424.76 lm/m)	30 ft (9.14 m)	✓	✓	✓
			Green	116.0	534.2 lm/ft (1752.1 lm/m)	493.0 lm/ft (1617.0 lm/m)	406.0 lm/ft (1331.68 lm/m)				
			Blue	24.0	110.5 lm/ft (362.5 lm/m)	102.0 lm/ft (334.6 lm/m)	84.0 lm/ft (275.52 lm/m)				
			Amber	26.0	119.7 lm/ft (392.7 lm/m)	110.5 lm/ft (362.4 lm/m)	91.0 lm/ft (298.48 lm/m)				
6.0 Static Color Series 2	1.4 in. (35.7 mm)	68 LEDs/ft (224 LEDs/m)	Red	37.0	204.2 lm/ft (669.8 lm/m)	188.7 lm/ft (618.9 lm/m)	155.4 lm/ft (509.712 lm/m)	28 ft (8.5 m)	✓	✓	✓
			Green	113.0	624.4 lm/ft (2048.2 lm/m)	576.3 lm/ft (1890.3 lm/m)	474.6 lm/ft (1556.688 lm/m)				
			Blue	23.0	127.1 lm/ft (416.9 lm/m)	117.3 lm/ft (384.8 lm/m)	96.6 lm/ft (316.9 lm/m)				
			Amber	24.0	132.6 lm/ft (435.0 lm/m)	122.4 lm/ft (401.6 lm/m)	100.8 lm/ft (330.7 lm/m)				
2.4 Static White Linea	1.97 in. (50 mm)	146 LEDs/ft (480 LEDs/m)	2700K	67	148.1 lm/ft (485.8 lm/m)	136.9 lm/ft (448.8 lm/m)	112.7 lm/ft (369.6 lm/m)	21.3 ft (6.5 m)	✓	N/A	N/A
			3000K	71	156.4 lm/ft (514.3 lm/m)	144.5 lm/ft (475.2 lm/m)	119 lm/ft (391.3 lm/m)				
			3500K	83	183.1 lm/ft (601.7 lm/m)	169.2 lm/ft (555.9 lm/m)	139.3 lm/ft (457.8 lm/m)				
			4000K	83	183.1 lm/ft (601.7 lm/m)	169.2 lm/ft (555.9 lm/m)	139.3 lm/ft (457.8 lm/m)				
3.0 Static White Linea	1.97 in. (50 mm)	146 LEDs/ft (480 LEDs/m)	2700K	66	182.2 lm/ft (598 lm/m)	168.3 lm/ft (552.5 lm/m)	138.6 lm/ft (455 lm/m)	21.3 ft (6.5 m)	✓	N/A	N/A
			3000K	73	201.5 lm/ft (661.5 lm/m)	186.2 lm/ft (611.2 lm/m)	153.3 lm/ft (503.3 lm/m)				
			3500K	78	215.3 lm/ft (706.6 lm/m)	198.9 lm/ft (652.8 lm/m)	163.8 lm/ft (537.6 lm/m)				
			4000K	83	229.1 lm/ft (751.6 lm/m)	211.7 lm/ft (694.5 lm/m)	174.3 lm/ft (571.9 lm/m)				
4.3 Static White Linea	1.97 in. (50 mm)	146 LEDs/ft (480 LEDs/m)	2700K	75	297.2 lm/ft (973.4 lm/m)	274.6 lm/ft (899.3 lm/m)	226.1 lm/ft (740.6 lm/m)	24.6 ft (7.5 m)	✓	N/A	N/A
			3000K	78	308.2 lm/ft (1012 lm/m)	284.8 lm/ft (935 lm/m)	234.5 lm/ft (770 lm/m)				
			3500K	86	340.4 lm/ft (1116.9 lm/m)	314.5 lm/ft (1031.9 lm/m)	259 lm/ft (849.8 lm/m)				
			4000K	86	340.4 lm/ft (1116.9 lm/m)	314.5 lm/ft (1031.9 lm/m)	259 lm/ft (849.8 lm/m)				
6.1 Variable White Linea	1.09 in. (27.78 mm)	175 LEDs/ft (576 LEDs/m)	2700K + 6500K	95	533.6 lm/ft (1750.8 lm/m)	493 lm/ft (1617.6 lm/m)	406 lm/ft (1332.1 lm/m)	16.4 ft (5 m)	✓	N/A	N/A

**RIBBONLYTE SPECIFICATIONS & COMPATIBILITY**

Available Wattages	Cuttable Length	LED Pitch	Color Temp.	lm/W without Lens	Delivered Lumens with Clear Lens	Delivered Lumens with Frosted Lens	Delivered Lumens with Milky Lens	Max Length	Compatible with Channel		
									IP20	IP65	IP68
1.0 Variable White Series 2	1.97 in. (50 mm)	42 LEDs/ft (140 LEDs/m)	2000K + 6500K	85.0	78.2 lm/ft (257 lm/m)	72.3 lm/ft (237 lm/m)	60 lm/ft (200 lm/m)	32.8 ft (10 m)	✓	✓	✓
3.0 Variable White Series 2	1.97 in. (50 mm)	42 LEDs/ft (140 LEDs/m)	2000K + 6500K	80.0	220.8 lm/ft (725 lm/m)	205.0 lm/ft (670 lm/m)	168.0 lm/ft (551.2 lm/m)	32.8 ft (10 m)	✓	✓	✓
6.0 Variable White Series 2	1.97 in. (50 mm)	42 LEDs/ft (140 LEDs/m)	2000K + 6500K	75.0	415 lm/ft (1,362 lm/m)	382.5 lm/ft (1255 lm/m)	315.0 lm/ft (1033.5 lm/m)	19 ft 8 in. (6 m)	✓	✓	✓
4.4 RGBW Series 2	1.97 in. (50 mm)	36 LEDs/ft (120 LEDs/m)	RGBW	45	188.1 lm/ft (617.2 lm/m) All LEDs at 100%	168.3 lm/ft (552.2 lm/m) All LEDs at 100%	148.5 lm/ft (487.2 lm/m) All LEDs at 100%	19 ft 8 in. (6 m)	✓	N/A	N/A
5.5 RGBW Series 2	1.97 in. (50 mm)	36 LEDs/ft (120 LEDs/m)	RGBW	59	308.8 lm/ft (1013.0 lm/m) All LEDs at 100%	275.8 lm/ft (904.9 lm/m) All LEDs at 100%	243.3 lm/ft (798.5 lm/m) All LEDs at 100%	IP65: 16 ft 4 in. (5 m) IP68: 19 ft 7.9 in. (6 m)	N/A	✓	✓
8.8 RGBW Series 2	1.97 in. (50 mm)	36 LEDs/ft (120 LEDs/m)	RGBW	61	510.2 lm/ft (1673.8 lm/m) All LEDs at 100%	456.3 lm/ft (1497.1 lm/m) All LEDs at 100%	402.6 lm/ft (1320.9 lm/m) All LEDs at 100%	16 ft 4 in. (5 m)	✓	N/A	N/A
4.4 5-in-1 RGBWW	2.46 in. (62.5 mm)	29 LED/ft (96 LED/m)	RGBWW	59	241.4 lm/ft (792.1 lm/m) All LEDs at 100%	220.7 lm/ft (724.0 lm/m) All LEDs at 100%	194.7 lm/ft (638.8 lm/m) All LEDs at 100%	16 ft 4 in. (5 m)	✓	N/A	N/A
8.8 5-in-1 RGBWW	2.46 in. (62.5 mm)	29 LED/ft (96 LED/m)	RGBWW	50	409.2 lm/ft (1342.6 lm/m) All LEDs at 100%	374.0 lm/ft (1227.1 lm/m) All LEDs at 100%	330.0 lm/ft (1082.7 lm/m) All LEDs at 100%	11 ft 6 in. (3.5 m)	✓	N/A	N/A
RGBW Addressable	3.94 in. (100 mm)	18 LEDs/ft (60 LEDs/m)	Red	33.5	30.8 lm/ft (101.2 lm/m)	28.5 lm/ft (93.5 lm/m)	23.5 lm/ft (77 lm/m)	16 ft 5.64 in. (5.02 m)	N/A	N/A	✓ IP67
			Green	82	75.4 lm/ft (247.5 lm/m)	69.7 lm/ft (228.7 lm/m)	57.4 lm/ft (188.3 lm/m)				
			Blue	15.5	14.2 lm/ft (46.7 lm/m)	13.2 lm/ft (43.2 lm/m)	10.8 lm/ft (35.6 lm/m)				
			White	103	94.8 lm/ft (310.9 lm/m)	87.6 lm/ft (287.3 lm/m)	72.1 lm/ft (236.6 lm/m)				
			All	40	222.8 lm/ft (730.8 lm/m)	205.8 lm/ft (675.2 lm/m)	169.5 lm/ft (556.1 lm/m)				
5.2 Warm Dim	3.94 in. (100 mm)	36 LEDs/ft (120 LEDs/m)	WARM DIM	55	263.1 lm/ft (863 lm/m)	244.8 lm/ft (803.25 lm/m)	201.6 lm/ft (661.5 lm/m)	16 ft 4 in. (5 m)	✓	✓	✓

**DIODE VISIBILITY CHART** (Data below applies to installations with Milky lens only)

 <p><b>No Visible Diode = N</b> Note: Linea RibbonLyte has no visible diode</p>			 <p><b>With Visible Diode = Y</b></p>						
Static White & Static Color RibbonLyte			Color Changing RibbonLyte						
0.75/1.5/2.2	3.0/4.4	5.0/6.0	4.4 RGBW Series 2	5.5 RGBW Series 2	8.8 RGBW Series 2	4.4 5-in-1 RGBWW	8.8 5-in-1 RGBWW	Warm Dim	Variable White
IP20 IP65 IP68	IP20 IP65 IP68	IP20 IP65 IP68	IP20	IP65 IP68	IP20	IP20	IP20	IP20 IP65 IP68	IP20 IP65 IP68
<b>N</b>	<b>N</b>	<b>N</b>	<b>N</b>	<b>N</b>	<b>N</b>	<b>Y</b>	<b>Y</b>	<b>N</b>	<b>N</b>

AVAILABLE DRIVERS / CONTROLLERS AND DIMMING OPTIONS / WIRE GAUGE CHART

NON-DIMMING ELECTRONIC DRIVERS      ELV & MLV DRIVERS      DIMMABLE DALI DRIVERS



**30W, 60W, 96W Non-Dimming Electronic Class 2 Drivers**

Part No.:  
• DRVW2430 (30 Watt)  
• DRVW2460 (60 Watt)  
• DRVW2496 (96 Watt)  
Output Voltage: 24 VDC  
Input Voltage: 120-277 VAC  
IP65, dry/damp location  
UL Listed



**240W, 320W Non-Dimming Electronic Drivers**

Part No.:  
• DRVW24240 (240 Watt)  
• DRVW24320 (320 Watt)  
Output Voltage: 24 VDC  
Input Voltage: 90-305 VAC  
IP65, dry/damp location  
UL Recognized



**60W, 96W Non-Dimming Compact Drivers**

Part No.:  
• DRV2460C (60 Watt)  
• DRV2496C (96 Watt)  
Output Voltage: 24 VDC  
Input Voltage: 120-277 VAC  
IP20, dry location  
UL Class P



**60W, 96W, 150W, 300W ELV/MLV Dimmable Drivers**

Part No.:  
• DRVW2460ELVMLV (60 Watt)  
• DRVW2496ELVMLV (96 Watt)  
• DRVW24150ELVMLV (150 Watt)  
• DRVW24300ELVMLV (300 Watt)  
Line Voltage Dimmable Drivers  
Output Voltage: 24 VDC  
Input Voltage: 100-277 VAC  
IP67, damp/wet location  
UL, CE, and CSA Listed



**100W 1 Channel, 100W 2 Channel, 150W 4 Channel Dimmable DALI Drivers**

Part No.:  
• DRV100DALI1CH (100W 1 channel)  
• DRV100DALI2CH (100W 2 channel)  
• DRV150DALI4CH (150W 4 channel)  
Output Voltage: 24 VDC  
Input Voltage: 120-277 VAC  
IP20, dry location  
CE, UL Recognized, FCC, RoHS, SELV

0-10V DRIVERS      ATHENA WIRELESS COMPATIBLE      DIMMABLE DALI-2 DRIVERS



**0-10V Dimmable Waterproof Drivers**

• Part No.: DRVW249610P (96 Watt)  
• Part No.: DRVW2428810P (288 Watt)  
Output Voltage: 24 VDC (+/- 0.5 V)  
Input Voltage: 100-277 VAC  
UL wet location  
UL Listed



**0-10V Dimmable 90W VW/WD Driver**

• Part No.: DRVRFWDVW2490120  
Output Voltage: 24 VDC  
Input Voltage: 100-277 VAC  
IP23, dry/damp location  
UL Listed



**94W Athena Wireless Compatible Drivers**

• Part No.: DRVW2494ATH1CH (1 channel)  
• Part No.: DRVW2494ATH2CH (2 channel)  
Output Voltage: 24 VDC  
Input Voltage: 100-277 VAC  
Dry location  
UL Listed



**96W DIMMABLE DALI-2 DT6 D4I & DALI-2 DT8 D4I DRIVERS**

• Part No.: DRVW2496DALI1CH (1 channel)  
• Part No.: DRVW2496DALI2CH (2 channel)  
Output Voltage: 24-26 VDC  
Input Voltage: 120-277 VAC  
IP67, wet location  
UL Listed

DMX CONTROLLERS, VARIABLE WHITE DIMMER, WARM DIM DIMMER - FOR COLOR CHANGING FIXTURES



**GLASS TOUCH WALL CONTROLLERS**  
Part No.: AWCRGBWWBK  
AWCVWBK



**1 ZONE WALL CONTROLLER**  
Part No.: DMXCTRLG



**5 ZONE WALL CONTROLLER**  
Part No.: DMXCTRL



**10 ZONE WALL CONTROLLER**  
Part No.: DMXCTRLD



**6 UNIVERSE DMX CONTROLLER**  
Part No.: DMXCTRLDR6U



**VARIABLE WHITE DIMMER**  
Part No.: RFDIMVWWH (White)  
RFDIMVWBK (Black)



**WARM DIM DIMMER**  
Part No.: RFDIMWDWH (White)  
RFDIMWDBK (Black)



**4 CHANNEL WATERPROOF DMX INTERFACE**  
Part No.: DMXINFWLCD4



**5 CHANNEL DMX INTERFACE**  
Part No.: DMXINFOLED5



**DMX OPTO SPLITTER**  
Part No.: DMXOS8

DRIVER AND RIBBONLYTE AT FULL LOAD

Wattages	30		60		96		150		200		240		300		320	
	Feet	Meters	Feet	Meters	Feet	Meters	Feet	Meters	Feet	Meters	Feet	Meters	Feet	Meters	Feet	Meters
24 AWG / 0.25 mm <sup>2</sup>	14	4.27	9	2.74	5.5	1.68	3.75	1.14	2.75	0.84	2.25	0.69	1.75	0.53	1.75	0.53
22 AWG / 0.34 mm <sup>2</sup>	22	6.71	14	4.27	9	2.74	5.75	1.75	4.5	1.37	3.5	1.07	2.75	0.84	2.75	0.84
20 AWG / 0.5 mm <sup>2</sup>	35	10.67	23	7.01	14	4.27	9	2.74	7	2.13	5.75	1.75	4.5	1.37	4.25	1.30
18 AWG / 0.75 mm <sup>2</sup>	56	17.07	37	11.28	23	7.01	15	4.57	11	3.35	9	2.74	7.5	2.29	7	2.13
16 AWG / 1.5 mm <sup>2</sup>	90	27.44	60	18.29	37	11.28	24	7.32	18	5.49	15	4.57	12	3.66	11	3.35
14 AWG / 2.5 mm <sup>2</sup>	142	43.29	95	28.96	59	17.99	38	11.59	28	8.54	23	7.01	19	5.79	17	5.18
12 AWG / 4 mm <sup>2</sup>	226	68.90	151	46.04	94	28.66	60	18.29	45	13.72	37	11.28	30	9.15	28	8.54
10 AWG / 6 mm <sup>2</sup>	360	109.76	240	73.17	150	45.73	96	29.27	72	21.95	60	18.29	48	14.63	45	13.72
8 AWG / 10 mm <sup>2</sup>	574	175.00	381	116.16	239	72.87	153	46.65	115	35.06	95	28.96	76	23.17	71	21.65

WIRING DIAGRAMS - STATIC WHITE / STATIC COLOR / RGBW / RGBA / RGBWW

0-10 V

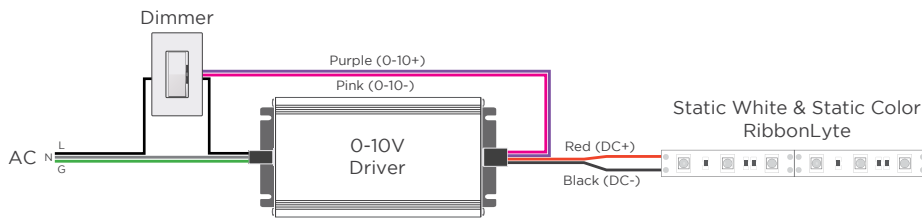

MLV / ELV

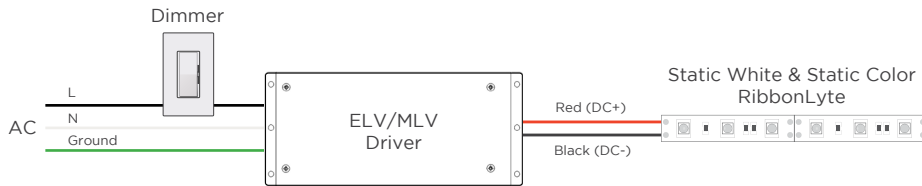

DMX WIRING WITH STATIC WHITE & STATIC COLOR RIBBONLYTE

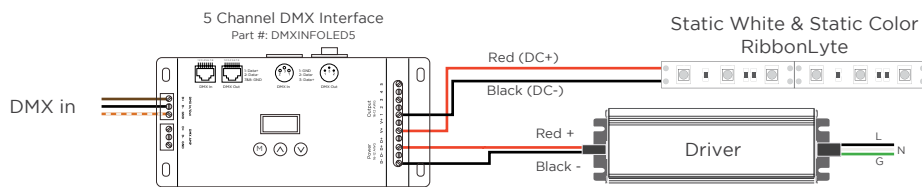

DALI-2 WIRING WITH STATIC WHITE & STATIC COLOR RIBBONLYTE

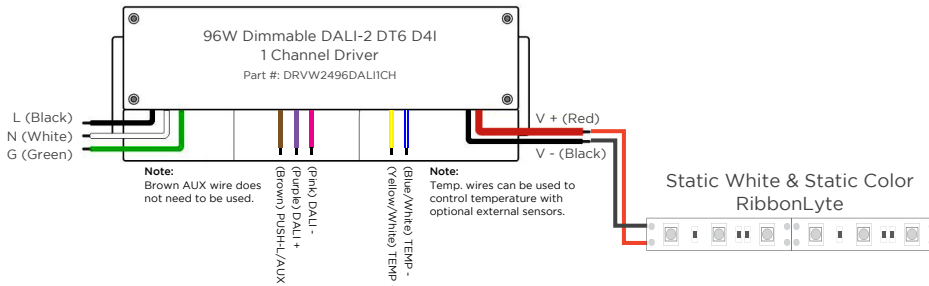

STATIC WHITE & STATIC COLOR RIBBONLYTE WIRING WITH ATHENA WIRELESS COMPATIBLE DRIVER

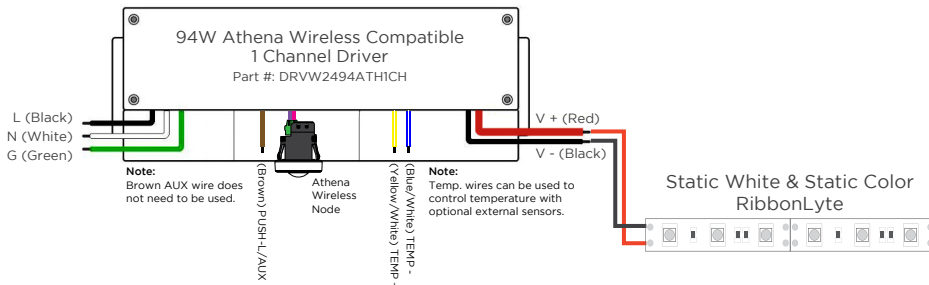

DMX WITH RGBWW 5-IN-1 RIBBONLYTE

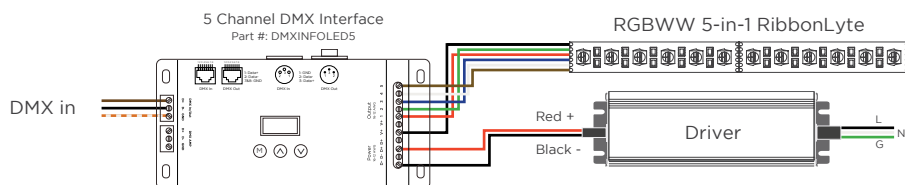

WIRE COLORS PER RIBBONLYTE COLOR

STATIC WHITE + STATIC COLOR

- Red Wire (+) Positive
- Black Wire (-) Negative

RGBW + RGBA

- Black Wire (+) Positive
- Green Wire (-) goes to Green Channel
- Red Wire (-) goes to Red Channel
- Blue Wire (-) goes to Blue Channel
- White Wire (-) goes to White Channel

RGBWW

- Black (+) Positive
- Green Wire (-) goes to Green Channel
- Red Wire (-) goes to Red Channel
- Blue Wire (-) goes to Blue Channel
- White Wire (-) goes to White Channel 1
- Brown Wire (-) goes to White Channel 2



WIRING DIAGRAMS - VARIABLE WHITE

2-CHANNEL VARIABLE WHITE DIMMING

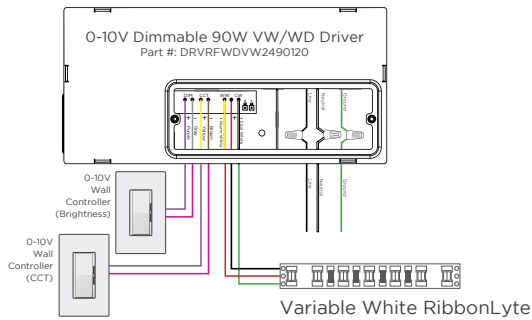

WIRE COLORS PER RIBBONLYTE COLOR

**VARIABLE WHITE**  
Black Wire (+) Positive  
Red Wire (-) goes to Warm White Channel  
Green Wire (-) goes to Cool White Channel

DMX WIRING WITH VARIABLE WHITE RIBBONLYTE

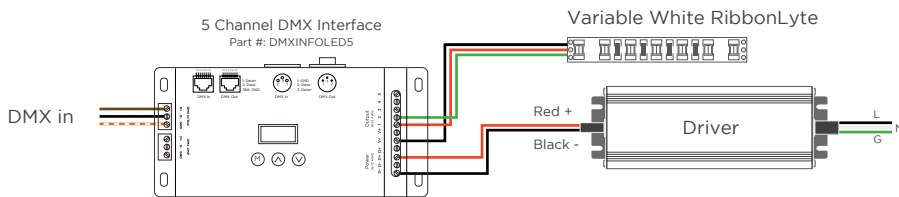

DALI-2 WIRING WITH VARIABLE WHITE RIBBONLYTE

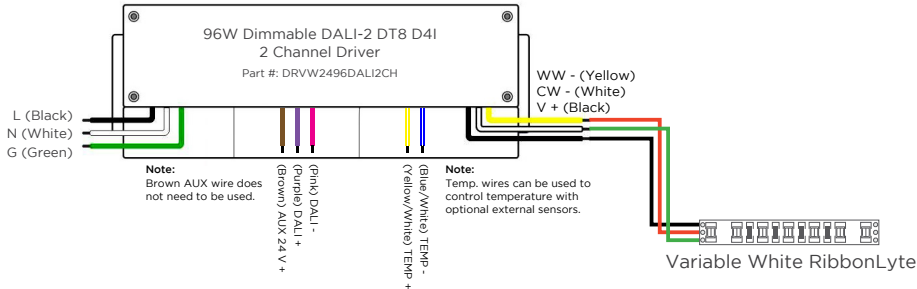

VARIABLE WHITE RIBBONLYTE WIRING WITH ATHENA WIRELESS COMPATIBLE DRIVER

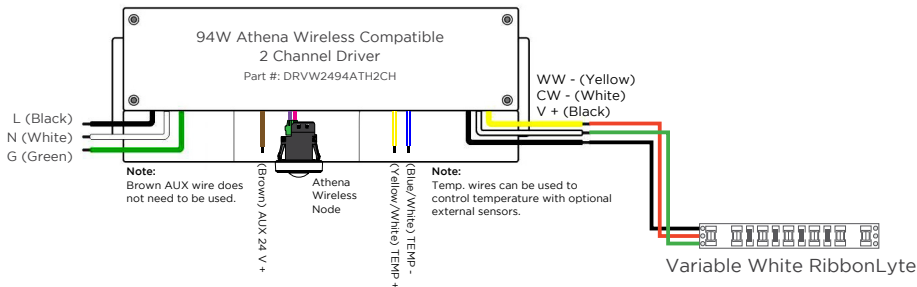

WIRING DIAGRAMS WITH RGBW ADDRESSABLE RIBBONLYTE

One DMX Universe consists of 128 addresses and 512 channels (42 ft, 8 in. of RibbonLyte).

Any single run of RibbonLyte that is less than 16 ft, 4 in. can be wired directly to the controller.

For additional runs, Opto Splitter must be used. Each individual run will need its own Opto Splitter output.

WIRE INDEX	
+	(24V +)
PI	(DMX GND)
A+	(DMX +)
B-	(DMX -)
GND	(24V -)

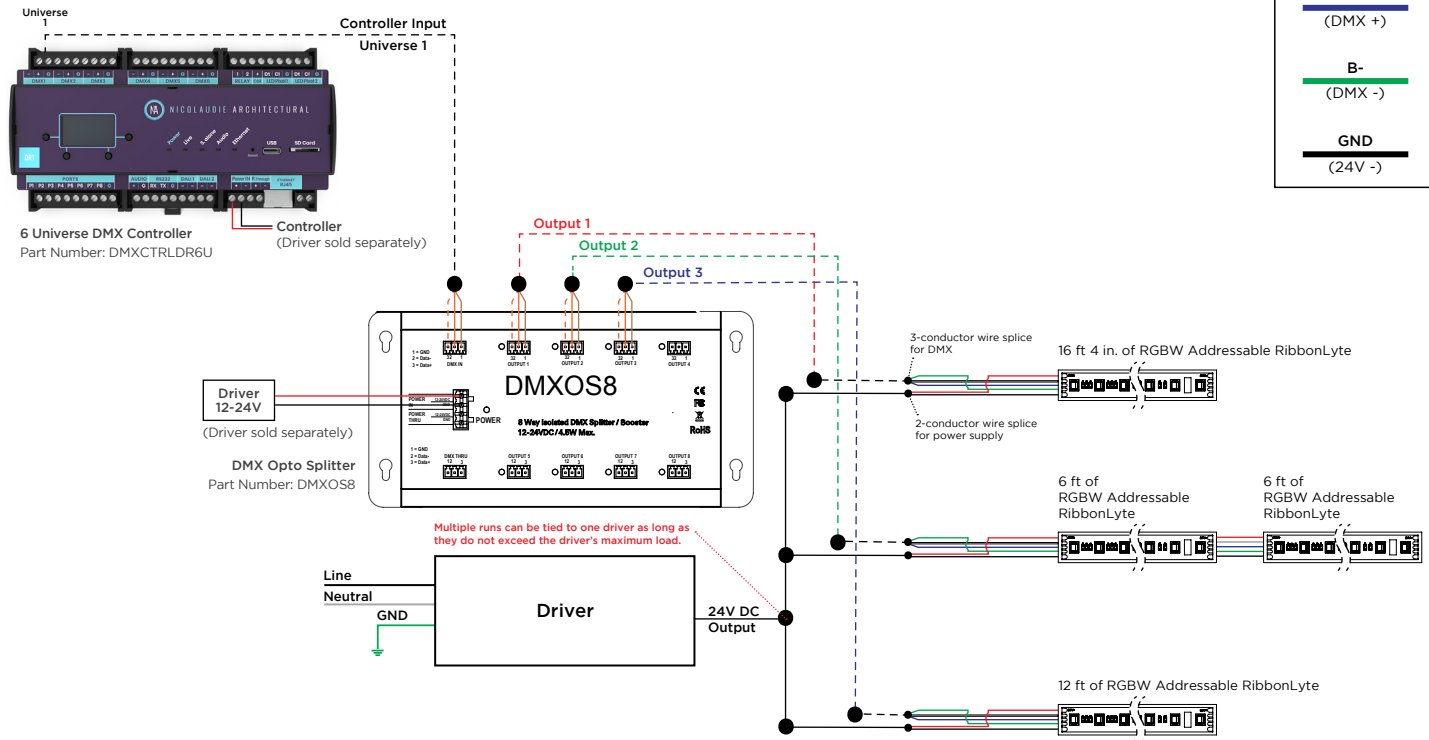

REV.07JAN2025

**GLOBAL HQ**

320 Murray Hill Pkwy  
East Rutherford, NJ 07073  
U.S.  
T: (+1) 212 629 6830  
E: Sales-US@GENLEDBrands.com

**EUROPEAN HQ**

Hogeweyselaan 119  
1382 JK Weesp  
Netherlands  
T: (+31) 346 235 000  
E: SalesEurope@GENLEDBrands.com

**MEINA HQ**

PO Box 371378, #823, Building 4EA  
Dubai Airport Free Zone  
Dubai, UAE  
T: (+971) 4 701 7901  
E: SalesMEINA@genlebrands.com

**ASIA-PACIFIC HQ**

Room 402, Building D  
Shenshi Tongchuang Science and Technology Park  
No. 16 Hongyin Road  
Xingqiang Community, Xinhui Street  
Guangming District, Shenzhen, China 518107  
Sales: (+86) 139 1836 3905  
Office: (+86) 755 8529 0710  
E: Sales-Pacific@GENLEDBrands.com