

Date \_\_\_\_\_ Project \_\_\_\_\_

Notes \_\_\_\_\_

### AT5 CHANNEL FIXTURE

Our AT5 Channel Fixture is a square channel with excellent diffusion and a 130-degree beam angle. We offer a variety of mounting options as well as your choice of clear, frosted and milky lenses to create a full range of light output and design. Custom design a fixture for nearly any application with our AT5 Channel and RibbonLyte products.

- Available for field assembly or factory assembly
- Beam Angle 130°
- Wattage Range from 0.75 W/ft (2.46 W/m) to 8.8 W/ft (28.9 W/m)
- Static White delivered lumen range from 44.1 lm/ft (144.6 lm/m) up to 729.4 lm/ft (2371.5 lm/m)
- Assembled in USA
- For interior applications only

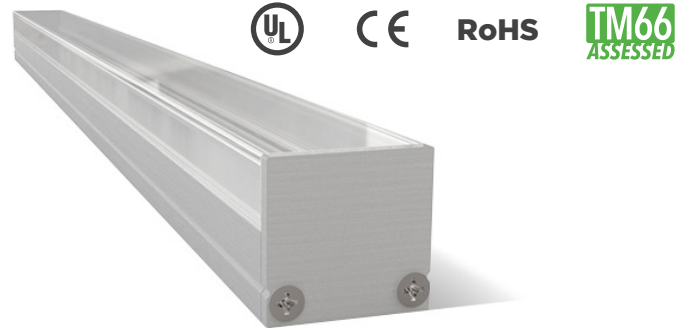

### HOUSING FINISHES



\*Additional fee applies

### AVAILABLE LENS FINISHES



### AVAILABLE COLORS & COLOR TEMPERATURES

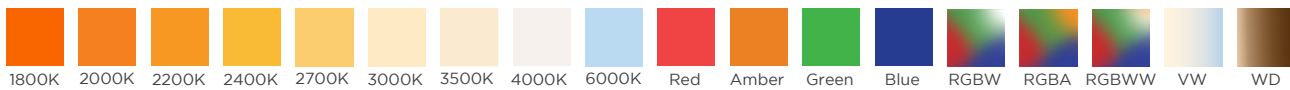

### DIMENSIONS

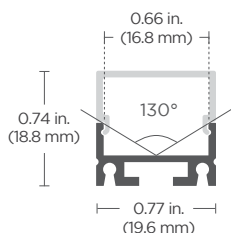
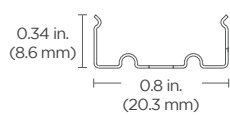
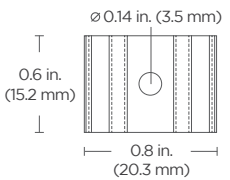
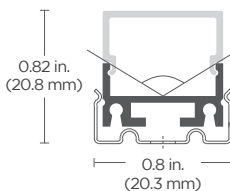
AT5 Channel	Mounting Clip (Included Accessory)		
 <p><b>Width:</b> 0.77 in. (19.6 mm) <b>Height:</b> 0.74 in. (18.8 mm) <b>Internal Width:</b> 0.66 in. (16.8 mm)</p>	<p><b>Side View</b></p>  <p><b>Width:</b> 0.8 in. (20.3 mm) <b>Length:</b> 0.8 in. (20.3 mm) <b>Height:</b> 0.34 in. (8.6 mm)</p>	<p><b>Top View</b></p>  <p><b>Width:</b> 0.6 in. (15.2 mm) <b>Length:</b> 0.8 in. (20.3 mm) <b>Height:</b> 0.34 in. (8.6 mm)</p>	<p><b>Assembled View</b></p>  <p><b>Width:</b> 0.8 in. (20.3 mm) <b>Height:</b> 0.82 in. (20.8 mm)</p>
<p><b>Note:</b></p> <ol style="list-style-type: none"> <li>1. Each section of channel includes <b>3 mounting clips</b>.</li> <li>2. <b>Magnetic mounting</b> option available (see page 2)</li> <li>3. <b>Raised lens</b> is for interior applications only</li> </ol>			

Acolyte does not warrant or represent that the information is free from errors or omission. The information may change without notice and Acolyte is not in any way liable for the accuracy of any information printed and stored or in any way interpreted or used.

**SPECIFICATIONS**

<b>Beam Angle</b>	130°
<b>Lens Type</b>	Clear Lens, Frosted Lens, Milky Lens
<b>Length</b>	Channel is sold by the foot and cut to your exact desired length. Required amount of mounting clips included.
<b>Operating Voltage</b>	24V
<b>Dimming</b>	MLV / 0-10 Volt / ELV / DALI / DMX
<b>Operating Temperature</b>	-40° F to 158° F (-40° C to 70° C)
<b>Colors</b>	1800K, 2000K, 2200K, 2400K, 2700K, 3000K, 3500K, 4000K, 6000K, Red, Amber, Green, Blue, RGBW, RGBWW, RGBA, VW, Warm Dim (1800K, 2000K, 2200K only available in IP20)
<b>CRI</b>	90+ CRI (Static white only)
<b>Lamp Life</b>	L70 at 50,000 Hours
<b>MacAdam Ellipses (SDCM)</b>	2-Step Binning (For Static White LEDs only)
<b>Certifications</b>	UL Listed UL 2108 Issued: 2004/02/27 Ed: 1 Rev: 2014/02/24 Low Voltage Lighting Systems CSA C22.2#9.0 Issued: 1996/06/01 Ed: 1 (R2011) General Requirements for Luminaires; with Gen. Inst. 1: 1997, Gen Inst. 2: 1998. ROHS compliant

**ACCESSORIES**

**Tiltable Stand (Part # TILTSTANDST)**

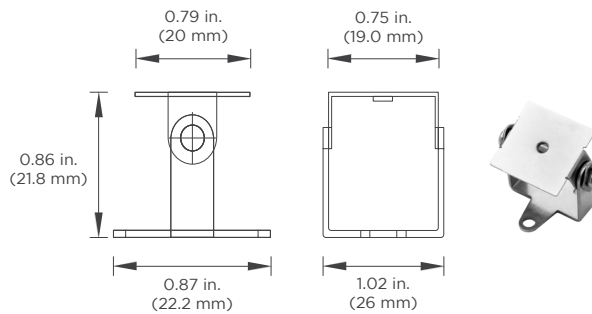

Assembled Height with Channel: 1.68 in. (42.6 mm)

**Magnetic Mount (Part #: CHMAGO.5)**

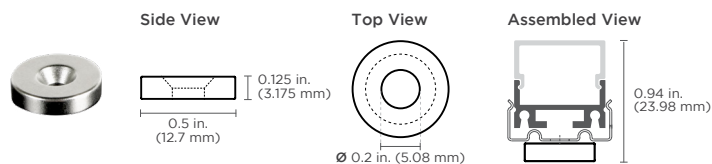

**Features:**

- High-energy neodymium magnets come attached to mounting clips with countersink hex nuts
- Create easy-mount magnetic channels with minimal surface gaps; no tools or drilling necessary
- Magnets rated for 8 lbs. of pull force with static load

**Applications:**

- Industrial lighting retrofits for troffers and other metal fixtures
- Metal retail shelf lighting
- Temporary light fixture installations

ORDERING GUIDE

**STEP 1** Complete Channel Part Number

CHANNEL	LENS	HOUSING COLOR
<b>CHAT5</b>		
CHAT5 - AT5 Channel For interior applications only	C - Clear Lens*    M - Milky Lens F - Frosted Lens    * Clear lens is the default option if not specified.	SV - Silver (default)    WH - White BK - Black Consult factory for custom colors

**STEP 2** Complete RibbonLyte Part Number

CATEGORY	CRI	RIBBON TYPE & IP RATING
<b>RB</b>		
RB - RibbonLyte	0 - Static Color, Color Changing 90 - 90+ CRI Static White	<b>LINEA20</b> - Linea RibbonLyte IP20 <b>SWS220</b> - Static White Series 2 IP20 <b>SWS265</b> - Static White Series 2 IP65 <b>SWS268</b> - Static White Series 2 IP68 <b>SCS220</b> - Static Color Series 2 IP20 <b>SCS265</b> - Static Color Series 2 IP65 <b>SCS268</b> - Static Color Series 2 IP68 <b>RGBWW20</b> - RGBWW 5-in-1 IP20 <b>RGBWS220</b> - RGBW Series 2 IP20 <b>RGBWS265</b> - RGBW Series 2 IP65 <b>RGBWS268</b> - RGBW Series 2 IP68 <b>VWS220</b> - VW Series 2 IP20 <b>VWS265</b> - VW Series 2 IP65 <b>VWS268</b> - VW Series 2 IP68 <b>WD20</b> - Warm Dim IP20 <b>WD65</b> - Warm Dim IP65 <b>WD68</b> - Warm Dim IP68

**NOTE:** To ensure waterproofing standards are met, IP65 and IP68 RibbonLyte can NOT be cut in the field.

WATTAGE	COLOR
0.75 - 0.75 W/ft (2.46 W/m - Static White, Static Color)	18 - 1800K    VW - Variable White
1.0 - 1.0 W/ft (3.3 W/m - Variable White)	20 - 2000K    RGB27 - Red, Green, Blue + 2700K
1.5 - 1.5 W/ft (4.9 W/m - Static White, Static Color)	22 - 2200K    RGB30 - Red, Green, Blue + 3000K
2.2 - 2.2 W/ft (7.2 W/m - Static White, Static Color)	24 - 2400K    RGB40 - Red, Green, Blue + 4000K
2.4 - 2.4 W/ft (8 W/m - Static White Linea)	27 - 2700K    RGB2465 - Red, Green, Blue + 2400K + 6500K
3.0 - 3.0 W/ft (9.8 W/m - Static White, Static Color, Variable White)	30 - 3000K    RGBA - Red, Green, Blue + Amber
4.3 - 4.3 W/ft (14 W/m - Static White Linea)	35 - 3500K    2920 - Warm Dim 2900K - 2000K (IP20)
4.4 - 4.4 W/ft (14.4 W/m - Static White, Static Color, RGBW, RGBWW, RGBA)	40 - 4000K    2721 - Warm Dim 2700K - 2100K (IP65+IP68)
5.0 - 5.0 W/ft (16.4 W/m - Static White, Static Color)	60 - 6000K    Z - Undecided**
5.2 - 5.2 W/ft (17.1 W/m - Warm Dim)	R - Red    ** For quotes only. Must be chosen before final order.
5.5 - 5.5 W/ft (18.0 W/m - RGBW, RGBA)	A - Amber
6.0 - 6.0 W/ft (19.7 W/m - Static White, Static Color, Variable White)	G - Green
6.1 - 6.1 W/ft (20 W/m - Variable White Linea)	B - Blue
8.8 - 8.8 W/ft (28.9 W/m - RGBW, RGBWW)	

CONNECTION OPTIONS (See diagrams on the right)	Custom Length (ft.)
1 - End Feed Bare Wire Connection	
2 - Back Feed Bare Wire Connection	
3 - Side Feed Bare Wire Connection	
4 - End Feed with IP67 Male Coupler	
5 - Soldered Daisy Chain	
6 - Daisy Chain With IP67 Couplers	

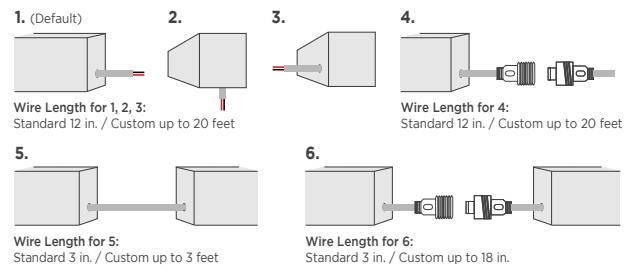

**STEP 3** Complete Assembly Option & Length

ASSEMBLY OPTION	LENGTH (Standard factory assembled length up to 6 ft 6.7 in. / 2 m)
FI - Field Assembly	
FA - Factory Assembly*	

\* Factory assembled runs exceeding 6 ft 6.7 in. (2 m) will be split into multiple daisy chained fixtures.

**STEP 4** Add Accessories

ACCESSORIES
TILTSTANDST - Tilttable Stand    CHMAGO.5 - Magnetic Mount

**DO NOT BUTT END CAPS AGAINST EACH OTHER WHEN CREATING LONGER FIXTURES**  
Acolyte STRONGLY SUGGESTS field assembly (without using interior end caps) for direct-view fixtures of more than 6 ft 6.7 in. (2 m) in length. Field assembly without interior end caps will eliminate gaps or dead spots that can be caused by butting interior end caps against each other.

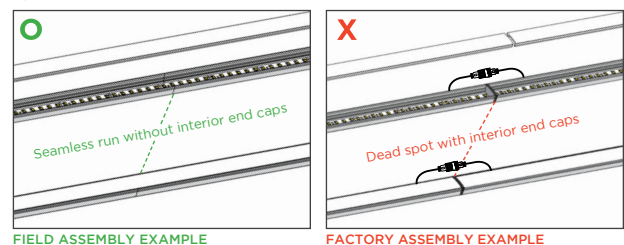



**RIBBONLYTE SPECIFICATIONS & COMPATIBILITY**

Available Wattages	Cuttable Length	LED Pitch	Color Temp.	lm/W without Lens	Delivered Lumens with Clear Lens	Delivered Lumens with Frosted Lens	Delivered Lumens with Milky Lens	Max Length	Compatible with Channel		
									IP20	IP65	IP68
0.75 Static White Series 2	1.97 in. (50 mm)	48 LEDs/ft (160 LEDs/m)	1800K	84	58 lm/ft (190.3 lm/m)	53.6 lm/ft (175.8 lm/m)	44.1 lm/ft (144.6 lm/m)	IP20: 49 ft (15 m) IP65/ IP68: 32.8 ft (10 m)	✓	✓	✓
			2000K	99	68.3 lm/ft (224 lm/m)	63.1 lm/ft (207 lm/m)	52 lm/ft (170.6 lm/m)				
			2200K	109	75.2 lm/ft (246.7 lm/m)	69.5 lm/ft (228 lm/m)	57.2 lm/ft (187.6 lm/m)				
			2400K	113	78 lm/ft (255.8 lm/m)	72.0 lm/ft (236.2 lm/m)	59.3 lm/ft (194.5 lm/m)				
			2700K	123	84.9 lm/ft (278.5 lm/m)	78.4 lm/ft (257.2 lm/m)	64.6 lm/ft (211.9 lm/m)				
			3000K	123	84.9 lm/ft (278.5 lm/m)	78.4 lm/ft (257.2 lm/m)	64.6 lm/ft (211.9 lm/m)				
			3500K	130	89.7 lm/ft (294.2 lm/m)	82.9 lm/ft (272 lm/m)	68.3 lm/ft (224 lm/m)				
			4000K	134	92.5 lm/ft (303.4 lm/m)	85.4 lm/ft (280.1 lm/m)	70.4 lm/ft (230.9 lm/m)				
			6000K	131	90.4 lm/ft (296.5 lm/m)	83.5 lm/ft (273.9 lm/m)	68.8 lm/ft (225.7 lm/m)				
1.5 Static White Series 2	1.97 in. (50 mm)	48 LEDs/ft (160 LEDs/m)	1800K	84	115.9 lm/ft (380.2 lm/m)	107.1 lm/ft (351.3 lm/m)	88.2 lm/ft (289.3 lm/m)	IP20: 49 ft (15 m) IP65/ IP68: 32.8 ft (10 m)	✓	✓	✓
			2000K	98	135.2 lm/ft (443.5 lm/m)	125 lm/ft (410 lm/m)	102.9 lm/ft (337.5 lm/m)				
			2200K	109	150.4 lm/ft (493.3 lm/m)	139 lm/ft (455.9 lm/m)	114.5 lm/ft (375.6 lm/m)				
			2400K	113	155.9 lm/ft (511.4 lm/m)	144.1 lm/ft (472.6 lm/m)	118.7 lm/ft (389.3 lm/m)				
			2700K	123	169.7 lm/ft (556.6 lm/m)	156.8 lm/ft (514.3 lm/m)	129.2 lm/ft (423.8 lm/m)				
			3000K	123	169.7 lm/ft (556.6 lm/m)	156.8 lm/ft (514.3 lm/m)	129.2 lm/ft (423.8 lm/m)				
			3500K	129	178 lm/ft (583.8 lm/m)	164.5 lm/ft (539.6 lm/m)	135.5 lm/ft (444.4 lm/m)				
			4000K	134	184.9 lm/ft (606.5 lm/m)	170.9 lm/ft (560.6 lm/m)	140.7 lm/ft (461.5 lm/m)				
			6000K	131	180.8 lm/ft (593 lm/m)	167 lm/ft (547.8 lm/m)	137.6 lm/ft (451.3 lm/m)				
2.2 Static White Series 2	1.97 in. (50 mm)	48 LEDs/ft (160 LEDs/m)	1800K	83	168 lm/ft (551 lm/m)	155.2 lm/ft (509.1 lm/m)	127.8 lm/ft (419.2 lm/m)	IP20: 42 ft (12.8 m) IP65/ IP68: 32.8 ft (10 m)	✓	✓	✓
			2000K	96	194.3 lm/ft (637.3 lm/m)	179.5 lm/ft (588.8 lm/m)	147.8 lm/ft (484.8 lm/m)				
			2200K	106	214.5 lm/ft (703.6 lm/m)	198.2 lm/ft (650.1 lm/m)	163.2 lm/ft (535.3 lm/m)				
			2400K	111	224.7 lm/ft (737 lm/m)	207.6 lm/ft (680.9 lm/m)	170.9 lm/ft (560.6 lm/m)				
			2700K	120	242.9 lm/ft (796.7 lm/m)	224.4 lm/ft (736 lm/m)	184.8 lm/ft (606.1 lm/m)				
			3000K	122	246.9 lm/ft (809.8 lm/m)	228.1 lm/ft (748.2 lm/m)	187.9 lm/ft (616.3 lm/m)				
			3500K	127	257 lm/ft (843 lm/m)	237.5 lm/ft (779 lm/m)	195.6 lm/ft (641.6 lm/m)				
			4000K	133	269.2 lm/ft (883 lm/m)	248.7 lm/ft (779 lm/m)	204.8 lm/ft (671.7 lm/m)				
			6000K	128	259.1 lm/ft (849.8 lm/m)	239.4 lm/ft (785.2 lm/m)	197.1 lm/ft (646.5 lm/m)				
3.0 Static White Series 2	1.97 in. (50 mm)	48 LEDs/ft (160 LEDs/m)	2400K	109.8	303.1 lm/ft (994.1 lm/m)	280.1 lm/ft (918.6 lm/m)	230.6 lm/ft (756.5 lm/m)	IP20: 36 ft (11 m) IP65/ IP68: 32.8 ft (10 m)	✓	✓	✓
			2700K	122.9	339.6 lm/ft (1114 lm/m)	313.5 lm/ft (1028.1 lm/m)	258.1 lm/ft (846.7 lm/m)				
			3000K	130	359.1 lm/ft (1177.9 lm/m)	331.4 lm/ft (1087.1 lm/m)	273 lm/ft (895.3 lm/m)				
			3500K	133	367.5 lm/ft (1205.3 lm/m)	339.2 lm/ft (1112.4 lm/m)	279.3 lm/ft (916.1 lm/m)				
			4000K	133	367.5 lm/ft (1205.3 lm/m)	339.2 lm/ft (1112.4 lm/m)	279.3 lm/ft (916.1 lm/m)				
			6000K	127	350.8 lm/ft (1150.5 lm/m)	323.7 lm/ft (1061.8 lm/m)	266.6 lm/ft (874.5 lm/m)				
4.4 Static White Series 2	1.97 in. (50 mm)	48 LEDs/ft (160 LEDs/m)	2400K	109	441.2 lm/ft (1447 lm/m)	407.7 lm/ft (1337.1 lm/m)	335.7 lm/ft (1101.2 lm/m)	28 ft 4 in. (8.64 m)	✓	✓	✓
			2700K	122	494.4 lm/ft (1621.6 lm/m)	456.3 lm/ft (1496.6 lm/m)	375.8 lm/ft (1232.5 lm/m)				
			3000K	129	522.8 lm/ft (1714.7 lm/m)	482.5 lm/ft (1582.5 lm/m)	397.3 lm/ft (1303.2 lm/m)				
			3500K	132	534.9 lm/ft (1754.5 lm/m)	493.7 lm/ft (1619.3 lm/m)	406.6 lm/ft (1333.5 lm/m)				
			4000K	132	534.9 lm/ft (1754.5 lm/m)	493.7 lm/ft (1619.3 lm/m)	406.6 lm/ft (1333.5 lm/m)				
			6000K	126	510.6 lm/ft (1674.8 lm/m)	471.2 lm/ft (1545.7 lm/m)	388.1 lm/ft (1272.9 lm/m)				
5.0 Static White Series 2	1.4 in. (35.7 mm)	68 LEDs/ft (224 LEDs/m)	2400K	109.8	505.1 lm/ft (1656.8 lm/m)	466.8 lm/ft (1531 lm/m)	384.4 lm/ft (1260.8 lm/m)	IP20: 33 ft 4 in. (10.1 m) IP65/ IP68: 32.8 ft (10 m)	✓	✓	✓
			2700K	122.9	566.1 lm/ft (1856.7 lm/m)	522.4 lm/ft (1713.6 lm/m)	430.2 lm/ft (1411.2 lm/m)				
			3000K	130	598.5 lm/ft (1963.2 lm/m)	552.4 lm/ft (1811.9 lm/m)	454.9 lm/ft (1492.1 lm/m)				
			3500K	133	612.5 lm/ft (2008.9 lm/m)	565.3 lm/ft (1854 lm/m)	465.5 lm/ft (1526.8 lm/m)				
			4000K	133	612.5 lm/ft (2008.9 lm/m)	565.3 lm/ft (1854 lm/m)	465.5 lm/ft (1526.8 lm/m)				
			6000K	127	584.6 lm/ft (1917.6 lm/m)	539.6 lm/ft (1769.7 lm/m)	444.3 lm/ft (1457.4 lm/m)				
6.0 Static White Series 2	1.4 in. (35.7 mm)	68 LEDs/ft (224 LEDs/m)	2400K	109	601.6 lm/ft (1973.2 lm/m)	555.9 lm/ft (1823.4 lm/m)	457.8 lm/ft (1501.6 lm/m)	28 ft (8.5 m)	✓	✓	✓
			2700K	122	674.2 lm/ft (2211.3 lm/m)	622.2 lm/ft (2040.8 lm/m)	512.4 lm/ft (1680.7 lm/m)				
			3000K	129	712.9 lm/ft (2338.2 lm/m)	657.9 lm/ft (2157.9 lm/m)	541.8 lm/ft (1777.1 lm/m)				
			3500K	132	729.4 lm/ft (2392.5 lm/m)	673.2 lm/ft (2208.1 lm/m)	554.4 lm/ft (1818.4 lm/m)				
			4000K	132	729.4 lm/ft (2392.5 lm/m)	673.2 lm/ft (2208.1 lm/m)	554.4 lm/ft (1818.4 lm/m)				
			6000K	126	696.3 lm/ft (2283.8 lm/m)	642.6 lm/ft (2107.7 lm/m)	529.2 lm/ft (1735.8 lm/m)				



**RIBBONLYTE SPECIFICATIONS & COMPATIBILITY**

Available Wattages	Cuttable Length	LED Pitch	Color Temp.	lm/W without Lens	Delivered Lumens with Clear Lens	Delivered Lumens with Frosted Lens	Delivered Lumens with Milky Lens	Max Length	Compatible with Channel		
									IP20	IP65	IP68
0.75 Static Color Series 2	1.97 in. (50 mm)	48 LEDs/ft (160 LEDs/m)	Red	41	28 lm/ft (93 lm/m)	26 lm/ft (86 lm/m)	22 lm/ft (70.6 lm/m)	IP20: 49 ft (15 m) IP65/ IP68: 32.8 ft (10 m)	✓	✓	✓
			Green	175	121 lm/ft (396 lm/m)	112 lm/ft (366 lm/m)	92 lm/ft (301.4 lm/m)				
			Blue	19	13 lm/ft (43 lm/m)	12 lm/ft (40 lm/m)	10 lm/ft (32.7 lm/m)				
			Amber	34	23 lm/ft (77 lm/m)	22 lm/ft (71 lm/m)	18 lm/ft (58.6 lm/m)				
1.5 Static Color Series 2	1.97 in. (50 mm)	48 LEDs/ft (160 LEDs/m)	Red	42	58 lm/ft (190 lm/m)	54 lm/ft (176 lm/m)	44 lm/ft (144.7 lm/m)	IP20: 49 ft (15 m) IP65/ IP68: 32.8 ft (10 m)	✓	✓	✓
			Green	160	221 lm/ft (724 lm/m)	204 lm/ft (669 lm/m)	168 lm/ft (551.1 lm/m)				
			Blue	18	25 lm/ft (81 lm/m)	23 lm/ft (75 lm/m)	19 lm/ft (62 lm/m)				
			Amber	34	47 lm/ft (154 lm/m)	43 lm/ft (142 lm/m)	36 lm/ft (117.1 lm/m)				
2.2 Static Color Series 2	1.97 in. (50 mm)	48 LEDs/ft (160 LEDs/m)	Red	42	85 lm/ft (279 lm/m)	79 lm/ft (258 lm/m)	65 lm/ft (212.2 lm/m)	IP20: 42 ft (12.8 m) IP65/ IP68: 32.8 ft (10 m)	✓	✓	✓
			Green	145	293 lm/ft (963 lm/m)	271 lm/ft (889 lm/m)	223 lm/ft (732.4 lm/m)				
			Blue	18	36 lm/ft (119 lm/m)	34 lm/ft (110 lm/m)	28 lm/ft (90.9 lm/m)				
			Amber	33	67 lm/ft (219 lm/m)	62 lm/ft (202 lm/m)	51 lm/ft (166.7 lm/m)				
3.0 Static Color Series 2	1.97 in. (50 mm)	48 LEDs/ft (160 LEDs/m)	Red	40.0	110.4 lm/ft (362.1 lm/m)	102.0 lm/ft (334.6 lm/m)	84.0 lm/ft (275.52 lm/m)	32.8 ft (10 m)	✓	✓	✓
			Green	127.0	350.9 lm/ft (1151.0 lm/m)	323.9 lm/ft (1062.2 lm/m)	266.7 lm/ft (874.776 lm/m)				
			Blue	25.0	69.1 lm/ft (226.6 lm/m)	63.8 lm/ft (209.1 lm/m)	52.5 lm/ft (172.2 lm/m)				
			Amber	29.0	80.1 lm/ft (262.8 lm/m)	74.0 lm/ft (242.6 lm/m)	60.9 lm/ft (199.752 lm/m)				
4.4 Static Color Series 2	1.97 in. (50 mm)	48 LEDs/ft (160 LEDs/m)	Red	38.0	153.8 lm/ft (504.5 lm/m)	142.1 lm/ft (466.2 lm/m)	117.0 lm/ft (383.8912 lm/m)	29 ft (8.8 m)	✓	✓	✓
			Green	117.0	474.1 lm/ft (1555.1 lm/m)	437.6 lm/ft (1435.3 lm/m)	360.4 lm/ft (1181.981 lm/m)				
			Blue	24.0	97.3 lm/ft (319.0 lm/m)	89.8 lm/ft (294.4 lm/m)	73.9 lm/ft (242.4576 lm/m)				
			Amber	25.0	101.3 lm/ft (332.2 lm/m)	93.5 lm/ft (306.7 lm/m)	77.0 lm/ft (252.56 lm/m)				
5.0 Static Color Series 2	1.4 in. (35.7 mm)	68 LEDs/ft (224 LEDs/m)	Red	37.0	170.2 lm/ft (558.2 lm/m)	157.3 lm/ft (515.8 lm/m)	129.5 lm/ft (424.76 lm/m)	30 ft (9.14 m)	✓	✓	✓
			Green	116.0	534.2 lm/ft (1752.1 lm/m)	493.0 lm/ft (1617.0 lm/m)	406.0 lm/ft (1331.68 lm/m)				
			Blue	24.0	110.5 lm/ft (362.5 lm/m)	102.0 lm/ft (334.6 lm/m)	84.0 lm/ft (275.52 lm/m)				
			Amber	26.0	119.7 lm/ft (392.7 lm/m)	110.5 lm/ft (362.4 lm/m)	91.0 lm/ft (298.48 lm/m)				
6.0 Static Color Series 2	1.4 in. (35.7 mm)	68 LEDs/ft (224 LEDs/m)	Red	37.0	204.2 lm/ft (669.8 lm/m)	188.7 lm/ft (618.9 lm/m)	155.4 lm/ft (509.712 lm/m)	28 ft (8.5 m)	✓	✓	✓
			Green	113.0	624.4 lm/ft (2048.2 lm/m)	576.3 lm/ft (1890.3 lm/m)	474.6 lm/ft (1556.688 lm/m)				
			Blue	23.0	127.1 lm/ft (416.9 lm/m)	117.3 lm/ft (384.8 lm/m)	96.6 lm/ft (316.9 lm/m)				
			Amber	24.0	132.6 lm/ft (435.0 lm/m)	122.4 lm/ft (401.6 lm/m)	100.8 lm/ft (330.7 lm/m)				
2.4 Static White Linea	1.97 in. (50 mm)	146 LEDs/ft (480 LEDs/m)	2700K	67	148.1 lm/ft (485.8 lm/m)	136.9 lm/ft (448.8 lm/m)	112.7 lm/ft (369.6 lm/m)	21.3 ft (6.5 m)	✓	N/A	N/A
			3000K	71	156.4 lm/ft (514.3 lm/m)	144.5 lm/ft (475.2 lm/m)	119 lm/ft (391.3 lm/m)				
			3500K	83	183.1 lm/ft (601.7 lm/m)	169.2 lm/ft (555.9 lm/m)	139.3 lm/ft (457.8 lm/m)				
			4000K	83	183.1 lm/ft (601.7 lm/m)	169.2 lm/ft (555.9 lm/m)	139.3 lm/ft (457.8 lm/m)				
3.0 Static White Linea	1.97 in. (50 mm)	146 LEDs/ft (480 LEDs/m)	2700K	66	182.2 lm/ft (598 lm/m)	168.3 lm/ft (552.5 lm/m)	138.6 lm/ft (455 lm/m)	21.3 ft (6.5 m)	✓	N/A	N/A
			3000K	73	201.5 lm/ft (661.5 lm/m)	186.2 lm/ft (611.2 lm/m)	153.3 lm/ft (503.3 lm/m)				
			3500K	78	215.3 lm/ft (706.6 lm/m)	198.9 lm/ft (652.8 lm/m)	163.8 lm/ft (537.6 lm/m)				
			4000K	83	229.1 lm/ft (751.6 lm/m)	211.7 lm/ft (694.5 lm/m)	174.3 lm/ft (571.9 lm/m)				
4.3 Static White Linea	1.97 in. (50 mm)	146 LEDs/ft (480 LEDs/m)	2700K	75	297.2 lm/ft (973.4 lm/m)	274.6 lm/ft (899.3 lm/m)	226.1 lm/ft (740.6 lm/m)	24.6 ft (7.5 m)	✓	N/A	N/A
			3000K	78	308.2 lm/ft (1012 lm/m)	284.8 lm/ft (935 lm/m)	234.5 lm/ft (770 lm/m)				
			3500K	86	340.4 lm/ft (1169.9 lm/m)	314.5 lm/ft (1031.9 lm/m)	259 lm/ft (849.8 lm/m)				
			4000K	86	340.4 lm/ft (1169.9 lm/m)	314.5 lm/ft (1031.9 lm/m)	259 lm/ft (849.8 lm/m)				
6.1 Variable White Linea	1.09 in. (27.78 mm)	175 LEDs/ft (576 LEDs/m)	2700K + 6500K	95	533.6 lm/ft (1750.8 lm/m)	493 lm/ft (1617.6 lm/m)	406 lm/ft (1332.1 lm/m)	16.4 ft (5 m)	✓	N/A	N/A

**RIBBONLYTE SPECIFICATIONS & COMPATIBILITY**

Available Wattages	Cuttable Length	LED Pitch	Color Temp.	lm/W without Lens	Delivered Lumens with Clear Lens	Delivered Lumens with Frosted Lens	Delivered Lumens with Milky Lens	Max Length	Compatible with Channel		
									IP20	IP65	IP68
1.0 Variable White Series 2	1.97 in. (50 mm)	42 LEDs/ft (140 LEDs/m)	2000K + 6500K	85.0	78.2 lm/ft (257 lm/m)	72.3 lm/ft (237 lm/m)	60 lm/ft (200 lm/m)	32.8 ft (10 m)	✓	✓	✓
3.0 Variable White Series 2	1.97 in. (50 mm)	42 LEDs/ft (140 LEDs/m)	2000K + 6500K	80.0	220.8 lm/ft (725 lm/m)	205.0 lm/ft (670 lm/m)	168.0 lm/ft (551.2 lm/m)	32.8 ft (10 m)	✓	✓	✓
6.0 Variable White Series 2	1.97 in. (50 mm)	42 LEDs/ft (140 LEDs/m)	2000K + 6500K	75.0	415 lm/ft (1,362 lm/m)	382.5 lm/ft (1255 lm/m)	315.0 lm/ft (1033.5 lm/m)	19 ft 8 in. (6 m)	✓	✓	✓
4.4 RGBW Series 2	1.97 in. (50 mm)	36 LEDs/ft (120 LEDs/m)	RGBW	45	188.1 lm/ft (617.2 lm/m) All LEDs at 100%	168.3 lm/ft (552.2 lm/m) All LEDs at 100%	148.5 lm/ft (487.2 lm/m) All LEDs at 100%	19 ft 8 in. (6 m)	✓	N/A	N/A
5.5 RGBW Series 2	1.97 in. (50 mm)	36 LEDs/ft (120 LEDs/m)	RGBW	59	308.8 lm/ft (1013.0 lm/m) All LEDs at 100%	275.8 lm/ft (904.9 lm/m) All LEDs at 100%	243.3 lm/ft (798.5 lm/m) All LEDs at 100%	IP65: 16 ft 4 in. (5 m) IP68: 19 ft 7.9 in. (6 m)	N/A	✓	✓
8.8 RGBW Series 2	1.97 in. (50 mm)	36 LEDs/ft (120 LEDs/m)	RGBW	61	510.2 lm/ft (1673.8 lm/m) All LEDs at 100%	456.3 lm/ft (1497.1 lm/m) All LEDs at 100%	402.6 lm/ft (1320.9 lm/m) All LEDs at 100%	16 ft 4 in. (5 m)	✓	N/A	N/A
4.4 5-in-1 RGBWW	2.46 in. (62.5 mm)	29 LED/ft (96 LED/m)	RGBWW	59	241.4 lm/ft (792.1 lm/m) All LEDs at 100%	220.7 lm/ft (724.0 lm/m) All LEDs at 100%	194.7 lm/ft (638.8 lm/m) All LEDs at 100%	16 ft 4 in (5 m)	✓	N/A	N/A
8.8 5-in-1 RGBWW	2.46 in. (62.5 mm)	29 LED/ft (96 LED/m)	RGBWW	50	409.2 lm/ft (1342.6 lm/m) All LEDs at 100%	374.0 lm/ft (1227.1 lm/m) All LEDs at 100%	330.0 lm/ft (1082.7 lm/m) All LEDs at 100%	11 ft 6 in (3.5 m)	✓	N/A	N/A
5.2 Warm Dim	3.94 in. (100 mm)	36 LEDs/ft (120 LEDs/m)	WARM DIM	55	263.1 lm/ft (863 lm/m)	244.8 lm/ft (803.25 lm/m)	201.6 lm/ft (661.5 lm/m)	16 ft 4 in. (5 m)	✓	✓	✓

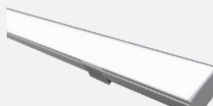
**DIODE VISIBILITY CHART** (Data below applies to installations with Milky lens only)

 <p><b>No Visible Diode = N</b> Note: Linea RibbonLyte has no visible diode</p>			 <p><b>With Visible Diode = Y</b></p>							
Static White & Static Color RibbonLyte			Color Changing RibbonLyte							
0.75/1.5/2.2	3.0/4.4	5.0/6.0	4.4 RGBW Series 2	5.5 RGBW Series 2	8.8 RGBW Series 2	4.4 5-in-1 RGBWW	8.8 5-in-1 RGBWW	Warm Dim	Variable White	
IP20 IP65 IP68	IP20 IP65 IP68	IP20 IP65 IP68	IP20	IP65 IP68	IP20	IP20	IP20	IP20 IP65 IP68	IP20	IP68
N	N	N	Y	Y	Y	Y	Y	Y	N	Y

AVAILABLE DRIVERS / CONTROLLERS AND DIMMING OPTIONS / WIRE GAUGE CHART

NON-DIMMING ELECTRONIC DRIVERS



**30W, 60W, 96W Non-Dimming Electronic Class 2 Drivers**

Part No.:  
 • DRVW2430 (30 Watt)  
 • DRVW2460 (60 Watt)  
 • DRVW2496 (96 Watt)  
 Output Voltage: 24 V  
 Voltage Range: 120-277 VAC  
 IP Rating: Dry or Damp  
 UL Listed



**240W, 320W Non-Dimming Electronic Drivers**

Part No.:  
 • DRVW24240 (240 Watt)  
 • DRVW24320 (320 Watt)  
 Output Voltage: 24 V  
 Voltage Range: 90-305 VAC  
 IP Rating: Dry or Damp  
 UL Recognized

ELV & MLV DRIVERS



**60W, 96W, 150W, 300W, 600w\_test ELV/MLV Dimmable Drivers**

Part No.:  
 • DRVW2460ELVMLV (60 Watt)  
 • DRVW2496ELVMLV (96 Watt)  
 • DRVW24150ELVMLV (150 Watt)  
 • DRVW24300ELVMLV (300 Watt)  
 Line Voltage Dimmable Drivers  
 Output Voltage: 24 V  
 Voltage Range: 100-277 VAC  
 IP Rating: IP67  
 UL, CE, and CSA Listed

0-10V DRIVERS



**0-10V Dimmable Waterproof Drivers**

**96W** Part No.: DRVW249610P  
**288W** Part No.: DRVW2428810P  
 Output Voltage: 24 V (+/- 0.5V)  
 Voltage Range: 100-277 VAC  
 Environmental Rating: UL Wet Location  
 UL Listed



**0-10V Dimmable 90W VW/WD Driver**

Part No.: DRVRFWDVW2490120

DMX CONTROLLER AND PART NUMBER - FOR COLOR CHANGING VERSIONS



**GLASS TOUCH WALL CONTROLLERS**

Part Number: AWCRGBWBK  
 AWCVWBK



**1 ZONE WALL CONTROLLER**

Part Number: DMXCTRLG



**5 ZONE WALL CONTROLLER**

Part Number: DMXCTRL



**10 ZONE WALL CONTROLLER**

Part Number: DMXCTRLD

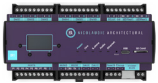

**2 UNIVERSE DMX CONTROLLER**

Part Number: DMXCTRLDR2U



**4 CHANNEL WATERPROOF DMX INTERFACE**

Part Number: DMXINFWLCD4



**5 CHANNEL DMX INTERFACE**

Part Number: DMXINFOLED5



**DMX OPTO SPLITTER**

Part Number: DMXOS8

**6 UNIVERSE DMX CONTROLLER**

Part Number: DMXCTRLDR6U

DRIVER AND RIBBONLYTE AT FULL LOAD

Wattages Wire Gauge	30		60		96		150		200		240		300		320	
	Feet	Meters	Feet	Meters	Feet	Meters	Feet	Meters	Feet	Meters	Feet	Meters	Feet	Meters	Feet	Meters
24 AWG / 0.25 mm <sup>2</sup>	14	4.27	9	2.74	5.5	1.68	3.75	1.14	2.75	0.84	2.25	0.69	1.75	0.53	1.75	0.53
22 AWG / 0.34 mm <sup>2</sup>	22	6.71	14	4.27	9	2.74	5.75	1.75	4.5	1.37	3.5	1.07	2.75	0.84	2.75	0.84
20 AWG / 0.5 mm <sup>2</sup>	35	10.67	23	7.01	14	4.27	9	2.74	7	2.13	5.75	1.75	4.5	1.37	4.25	1.30
18 AWG / 0.75 mm <sup>2</sup>	56	17.07	37	11.28	23	7.01	15	4.57	11	3.35	9	2.74	7.5	2.29	7	2.13
16 AWG / 1.5 mm <sup>2</sup>	90	27.44	60	18.29	37	11.28	24	7.32	18	5.49	15	4.57	12	3.66	11	3.35
14 AWG / 2.5 mm <sup>2</sup>	142	43.29	95	28.96	59	17.99	38	11.59	28	8.54	23	7.01	19	5.79	17	5.18
12 AWG / 4 mm <sup>2</sup>	226	68.90	151	46.04	94	28.66	60	18.29	45	13.72	37	11.28	30	9.15	28	8.54
10 AWG / 6 mm <sup>2</sup>	360	109.76	240	73.17	150	45.73	96	29.27	72	21.95	60	18.29	48	14.63	45	13.72
8 AWG / 10 mm <sup>2</sup>	574	175.00	381	116.16	239	72.87	153	46.65	115	35.06	95	28.96	76	23.17	71	21.65

WIRING DIAGRAMS

0-10V

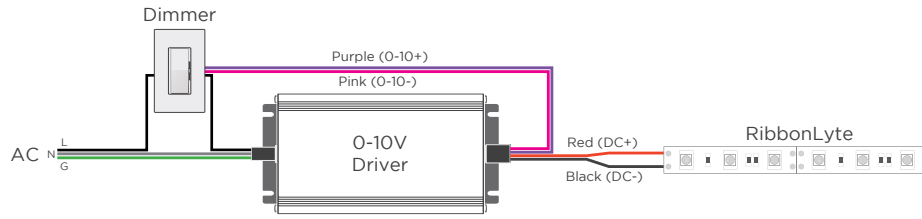

MLV / ELV

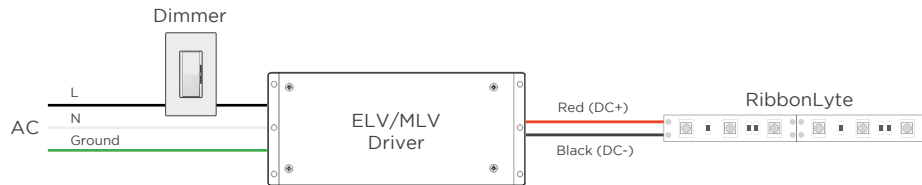

DMX

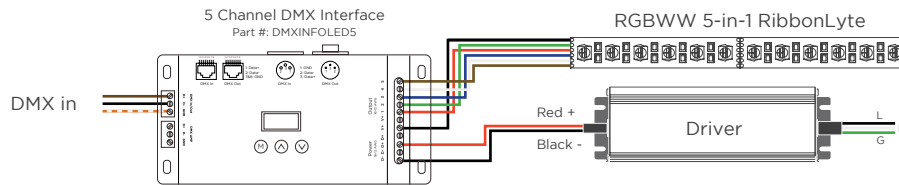

WARM DIM

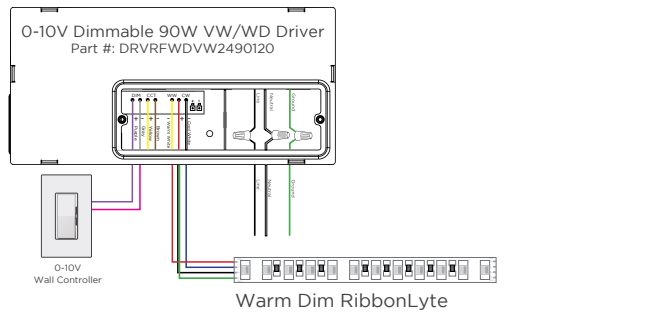

2-CHANNEL VARIABLE WHITE DIMMING

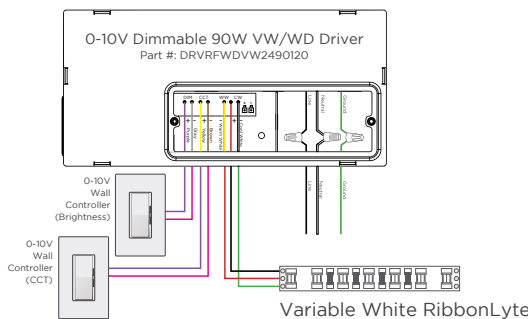

DMX WIRING DIAGRAM - COMPATIBLE WITH ALL MODELS OF VARIABLE WHITE RIBBONLYTE

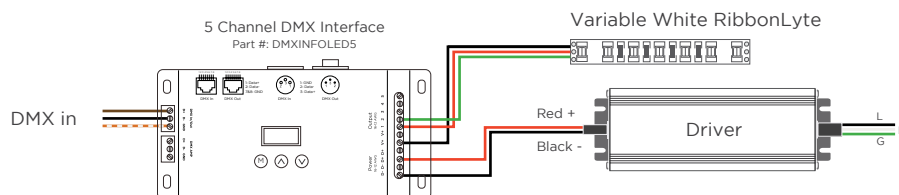

WIRE COLORS PER RIBBONLYTE COLOR

STATIC WHITE + STATIC COLOR

Red Wire (+) Positive  
Black Wire (-) Negative

RGBW + RGBA

Black Wire (+) Positive  
Green Wire (-) goes to Green Channel  
Red Wire (-) goes to Red Channel  
Blue Wire (-) goes to Blue Channel  
White Wire (-) goes to White Channel

RGBWW

Black (+) Positive  
Green Wire (-) goes to Green Channel  
Red Wire (-) goes to Red Channel  
Blue Wire (-) goes to Blue Channel  
White Wire (-) goes to White Channel 1  
Brown Wire (-) goes to White Channel 2

WARM DIM

Red Wire (-) goes to Warm White Channel  
Blue Wire (-) goes to Cool White Channel  
Black Wire (+) goes to Warm White Channel  
Green Wire (+) goes to Cool White Channel

VARIABLE WHITE

Black Wire (+) Positive  
Red Wire (-) goes to Warm White Channel  
Green Wire (-) goes to Cool White Channel

REV.24JUL2024

GLOBAL HQ

320 Murray Hill Pkwy  
East Rutherford, NJ 07073  
T: (+1) 212 629 6830  
E: Sales-US@GENLEDBrands.com

EUROPEAN HQ

De Corridor 16K  
3621ZB Breukelen  
Netherlands  
T: (+31) 346 235 000  
E: SalesEurope@GENLEDBrands.com

MEINA HQ

PO Box 371378, #823, Building 4EA  
Dubai Airport Free Zone, Dubai, UAE  
T: (+971) 4 701 7901  
E: SalesMEINA@genledebrands.com

ASIA-PACIFIC HQ

Room 402, Building D  
Shenxi Tongchuang Science and Technology Park  
No. 16 Hongyin Road  
Xingqiang Community, Xinhua Street  
Guangming District, Shenzhen, China 518107  
Sales: (+86) 139 1836 3905  
Office: (+86) 755 8529 0710  
E: Sales-Pacific@GENLEDBrands.com

[linkedin.com/company/genledeacolyte](https://www.linkedin.com/company/genledeacolyte)

[facebook.com/acolyteled](https://www.facebook.com/acolyteled)

[instagram.com/acolyte\\_led](https://www.instagram.com/acolyte_led)