

### NEON SILHOUETTE PLUS

This bendable, waterproof silicone fixture features all the benefits of modern LEDs while creating the classic look of pinpoint neon lines. Available in static white, static colors, variable white, RGBW and RGBW Addressable options, our Neon Silhouette Plus is designed with a larger profile to brave the elements in façade lighting and lettering. It's like neon, but better – and bigger!

- Flexible silicone LED tube creates vivid colors and bold statements
- Waterproof and UV resistant
- Sleek, flat design helps create elegant lighting solutions
- 110° beam angle
- Assembled in U.S.

#### Applications:

- |               |               |                  |
|---------------|---------------|------------------|
| Commercial    | Hospitality   | Residential      |
| Entertainment | Museums       | Retail / Signage |
| Healthcare    | Public Spaces |                  |

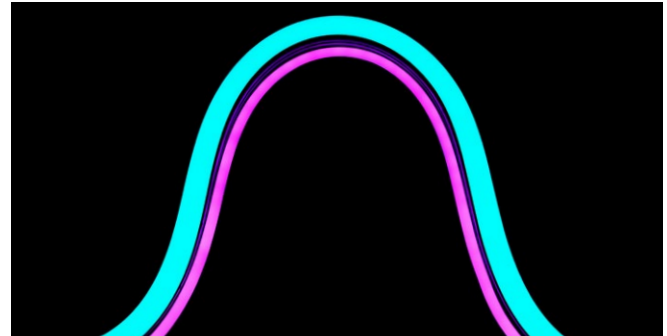

### ORDERING GUIDE

Category	Wattage & Color		Power Feed Direction
<b>NLSP</b>			
NLSP - Neon Silhouette Plus	<b>4.524</b> - 4.5 W/ft 2400K <b>4.527</b> - 4.5 W/ft 2700K <b>4.530</b> - 4.5 W/ft 3000K <b>4.535</b> - 4.5 W/ft 3500K <b>4.540</b> - 4.5 W/ft 4000K <b>4.550*</b> - 4.5 W/ft 5000K <b>4.560*</b> - 4.5 W/ft 6000K <b>4.5VW</b> - 4.5 W/ft Variable White * Special orders only	<b>4.5R*</b> - 4.5 W/ft Red <b>4.5G*</b> - 4.5 W/ft Green <b>4.5B*</b> - 4.5 W/ft Blue <b>4.5A*</b> - 4.5 W/ft Amber <b>4.5P*</b> - 4.5 W/ft Pink <b>4.5RGB27</b> - 4.5 W/ft RGB+White (2700K) <b>4.5RGB40</b> - 4.5 W/ft RGB+White (4000K) <b>4.3RGB27ADD</b> - 4.3 W/ft RGBW (2700K) Addressable <b>4.3RGB40ADD</b> - 4.3 W/ft RGBW (4000K) Addressable	<b>E</b> - End Feed <b>S</b> - Side Feed <b>B</b> - Bottom Feed

#### Mounting

- 1. Aluminum Mounting Clip**  
Part #: NLSPLUSMOUNTCLIPV2
- 2. Neon Silhouette Plus Mounting Channel**  
Sold by the foot, up to 6 ft 6 in. / 2 m  
Part #: NLSPOCHV2

### AVAILABLE COLORS AND COLOR TEMPERATURES

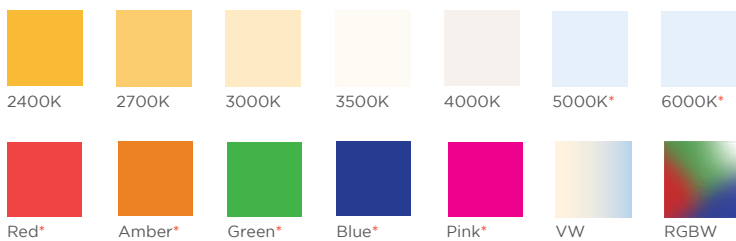

\* Special orders only

POWER FEED OPTIONS / SPECIFICATIONS / USAGE GUIDELINES

SPECIFICATIONS	NEON SILHOUETTE PLUS
Operating Voltage	Static White & Static Color, RGBW: Constant Current 24V DC Variable White & RGBW Addressable: Constant Voltage 24V DC
Power Consumption	Static White / Static Colors / Variable White, RGBW: 4.5 W/ft (14.76 W/m) RGBW Addressable: 4.3 W/ft (14.1 W/m)
Protection Rating	IP67
Beam Angle	110°
Dimming	ELV / MLV / 0-10 Volt / DMX / Lutron A-Series 1% dimming LED drivers
Operating Temperature	-13° F to 95° F (-25° C to 35° C)
Color Temperatures / Colors	2400K, 2700K, 3000K, 3500K, 4000K, 5000K*, 6000K*, Red*, Green*, Blue*, Amber*, Pink*, Variable White (2700K-5400K), RGBW (2700K), RGBW (4000K), RGBW (2700K) Addressable, RGBW (4000K) Addressable
Lamp Life	50,000 Hours
Max Length	Static White: 26 ft 3 in. (8 m) Red, Amber: 59 ft 0.6 in. (18 m) / Green, Blue, Pink: 45 ft 11.2 in. (14 m) Variable White, RGBW Addressable: 16 ft 4.9 in. (5 m) / RGBW: 32 ft 9.7 in. (10 m)
Cuttable Length	Static White, Static Color, Variable White: 1.97 in (50 mm) RGBW, RGBW Addressable: 4.92 in. (125 mm)
Power Cable Length	Standard: 12 in. (304.8 mm) / Custom: up to 20 ft (6 m)
UV Resistant	UV tested in accordance with ISO 4892-3 with no visible change on the appearance of the sample
Minimum Bend Diameter	9.44 in. (240 mm) Not Field Cuttable
CRI (white)	90+ for all Color Temperatures
Lumens	<b>4.5 Static White</b> 3500K: 262 lm/ft (859.4 lm/m), 58 lm/W
	<b>4.5 Static Color</b> Red: 62 lm/ft (203.4 lm/m), 14 lm/W Green: 144 lm/ft (472.3 lm/m), 32 lm/W Blue: 28 lm/ft (91.8 lm/m), 6 lm/W Amber: 12 lm/ft (39.4 lm/m), 3 lm/W Pink: 61 lm/ft (200.1 lm/m), 13 lm/W
	<b>4.5 Variable White</b> 159 lm/ft (521.5 lm/m), 35 lm/W
	<b>4.5 RGBW</b> Red: 11 lm/ft (36.1 lm/m), 10 lm/W / Green: 33 lm/ft (108.2 lm/m), 29 lm/W / Blue: 10 lm/ft (32.8 lm/m), 9 lm/W White: 40 lm/ft (131.2 lm/m), 35 lm/W / All LEDs at 100%: 97 lm/ft (318.2 lm/m), 22 lm/W
	<b>4.3 RGBW Addressable</b> Red: 7 lm/ft (23 lm/m), 7 lm/W / Green: 21 lm/ft (68.9 lm/m), 21 lm/W / Blue: 6 lm/ft (19.7 lm/m), 6 lm/W White: 39 lm/ft (127.9 lm/m), 39 lm/W

\* Special orders only

POWER FEED OPTIONS



End Feed - Power From End



Side Feed - Power From Side



Bottom Feed - Power From Bottom

USAGE GUIDELINES

- When installing this product take into account the surface temperature of the material this product is mounted to. Many building surfaces which are exposed to direct sunlight exceed the 95° F/35° C maximum that our product is rated for. High-risk locations like this should be avoided.
- This product is not intended to be submerged in pools and fountains and does not carry UL 676 certification to do so. Available for download at [www.GENLEDBrands.com/Acolyte](http://www.GENLEDBrands.com/Acolyte)
- Compatible with a wide variety of control products including the entire line of Lutron dimming systems.
- For use with Acolyte drivers, triac dimming modules, and 0-10 modules.
- Use with non-Acolyte triac, MLV or ELV drivers is not supported or warranted
- Due to the cuttable points inside, this product's cuttable lengths are generally longer or shorter than the customer requested length. Unless specified, this product is factory cut at the shorter cuttable point
- This product can be used in wet, outdoor locations around swimming pools and spa tubs, but not submerged in swimming pools and spa tubs.
- We reserve the right to make changes to product lineup, specifications, design and finishes at any time without notice.

Acolyte does not warrant or represent that this information is free from errors or omission. The information may change without notice and Acolyte is not in any way liable for the accuracy of any information printed and stored or in any way interpreted or used.

DIMENSIONS / DIAGRAMS

DIMENSIONS		NEON SILHOUETTE PLUS
FLEX CHANNEL		
IP68	Assembled Width	0.57 in. (14.4 mm)
	Length	Varies (see dimensions on pg. 2) (Not Field Cuttable)



DIAGRAMS		NEON SILHOUETTE PLUS
TUBE	<p><b>TUBE</b></p> <p>0.79 in. (20 mm) 0.47 in. (12 mm)</p> <p><b>END CAP</b></p> <p>0.87 in. (22.6 mm) 0.56 in. (14.6 mm)</p>	<p><b>TUBE OUTER HEIGHT:</b> 0.79 in. / 20 mm <b>TUBE OUTER WIDTH:</b> 0.47 in. / 12 mm</p> <p><b>END CAP HEIGHT:</b> 0.87 in. / 22.6 mm <b>END CAP WIDTH:</b> 0.56 in. / 14.6 mm</p>
	<p><b>MOUNTING CLIP</b></p> <p><b>SIDE VIEW</b></p> <p>0.74 in. (18.9 mm) 0.5 in. (12.6 mm)</p> <p><b>TOP VIEW</b></p> <p>0.79 in. (20 mm) 0.5 in. (12.6 mm)</p> <p><b>ASSEMBLED VIEW</b></p>	<p><b>MOUNTING CLIP OVERALL HEIGHT:</b> 0.74 in. / 18.9 mm <b>MOUNTING CLIP LENGTH:</b> 0.79 in. / 20 mm <b>MOUNTING CLIP WIDTH:</b> 0.5 in. / 12.6 mm <b>MOUNTING CLIP SCREW TOP DIAMETER:</b> 0.13 in. / 3.2 mm <b>MOUNTING CLIP THICKNESS:</b> 0.4 in. / 1.4 mm <b>MOUNTING CHANNEL:</b> Sold by the foot, up to 6 ft 6 in. / 2 m (Part #: NLSPCHV2)</p> <p>Use (1) mounting clip per foot unless specific shapes require more *Recommended mounting clip screw size: #4-40</p>

DISCLAIMER

When installing this product take into account the surface temperature of the material this product is mounted to. Many building surfaces which are exposed to direct sunlight exceed the 95° F/35° C maximum that our product is rated for. High-risk locations like this should be avoided.

This product is not intended to be submerged in pools and fountains and does not carry UL 676 certification to do so.

WIRING DIAGRAMS

0-10V

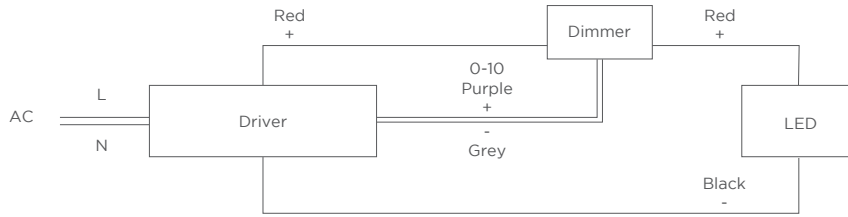

MAGNETIC + ELV

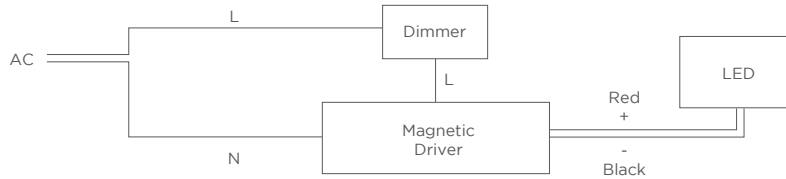

DMX

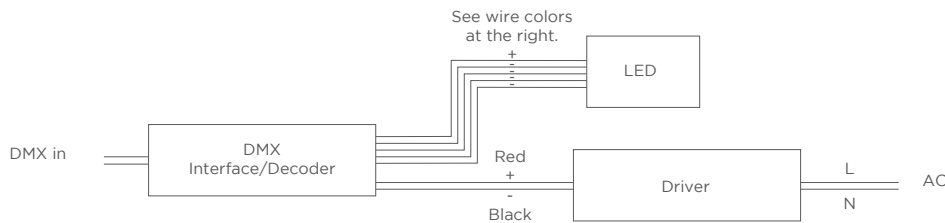

WARM DIM

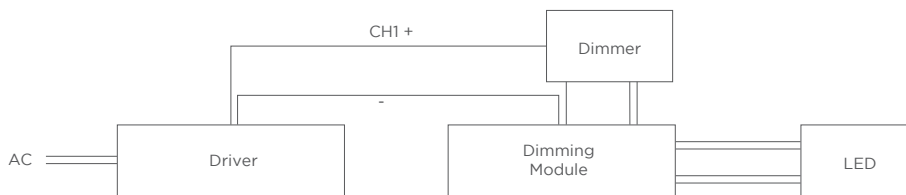

2-CHANNEL VARIABLE WHITE DIMMING

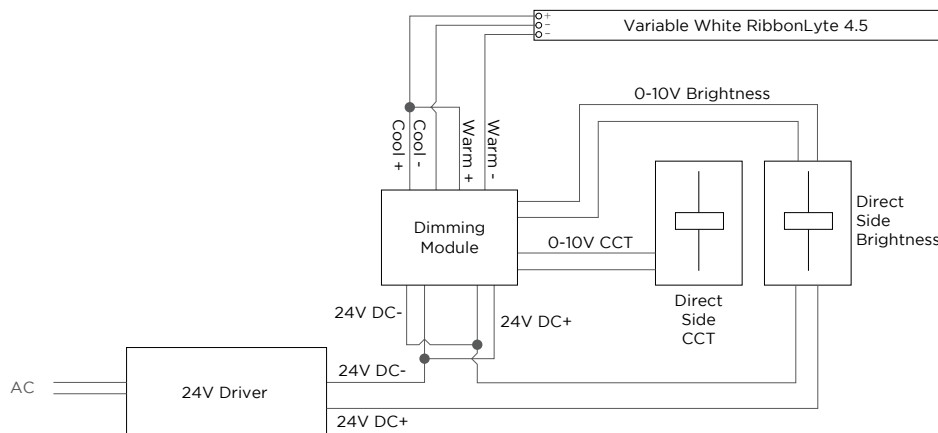

WIRE COLORS PER RIBBONLYTE COLOR

STATIC WHITE + STATIC COLOR

Red Wire (+) Positive  
Black Wire (-) Negative

RGBW/A

Black Wire (+) Positive  
Red Wire (-) goes to Red Channel  
Green Wire (-) goes to Green Channel  
Blue Wire (-) goes to Blue Channel  
White Wire (-) goes to White Channel

VARIABLE WHITE

Black Wire (+) Positive  
Red Wire (-) goes to Warm White Channel  
Green Wire (-) goes to Cool White Channel

WARM DIM

Red Wire (-) goes to Warm White Channel  
Blue Wire (-) goes to Cool White Channel  
Black Wire (+) goes to Warm White Channel  
Green Wire (+) goes to Cool White Channel