

### 6.0 VARIABLE WHITE SERIES 2 RIBBONLYTE

Our Variable White Series 2 RibbonLyte allows you to adjust for brightness and warmth like never before. Now with 140 LEDs per meter, our improved RibbonLyte provides better color mixing, reduced diode visibility and a wider range of color temperatures for tuning your lighting design. Available in three wattages and with a 50 mm cut length, you can use Variable White Series 2 RibbonLyte with a 2-channel dimmer to create bright, clear, colder light or the warmest, softest tones.



- Single-row, dual-chip layout means 140 LEDs per meter (42 LEDs per foot!)
- Available in three (3) wattages (1 W/ft, 3 W/ft, 6 W/ft)
- 50 mm cut length adds amazing flexibility to your design
- Color temperature range of 2000K to 6500K and 90+ CRI
- 2-channel dimming! One channel controls brightness and one controls temperature
- 6.0 W/ft (19.7 W/m)
- All on: 73 lm/W
- All on: 437.4 lm/ft (1434.67 lm/m)



RoHS

IP20

IP65

IP68

Declare.



### ORDERING GUIDE

Category	CRI	Ribbon Type & IP Rating	Wattage + Color
RB	0		6.0VW
RB - Ribbonlyte	0 - Color Changing	VWS220 - VW Series 2 IP20 VWS265 - VW Series 2 IP65 VWS268 - VW Series 2 IP68	6.0VW - 6.0 W/ft (19.7 W/m) Variable White

### CONNECTION OPTIONS

#### 1. End Feed Bare Wire Connection (Default Option)



#### 2. IP67 Connector Input



#### 3. Soldered Daisy Chain



#### 4. Daisy Chain with IP67 Connectors



#### 5. Bare Wire on Both Ends



#### Standard cable length if not specified:

1. 12 in. cable with bare wire (custom length up to 20 feet)
2. Standard 12 in. cable with IP67 connectors (custom length up to 10 feet)
3. Daisy chain with 3 in. cable between runs (custom length up to 36 in.)
4. 3 in. cable between IP67 connector and RibbonLyte (custom length up to 18 in.)
5. Standard 12 in. cable with bare wire (custom length up to 10 feet)

Note: IP67 connectors are used for both IP20 and IP65/IP68 RibbonLyte

### AVAILABLE COLOR TEMPERATURES









VW





SPECIFICATIONS / DIAGRAM / USAGE GUIDELINES

6.0 VARIABLE WHITE SERIES 2 RIBBONLYTE			
Operating Voltage	24 V		
Operating Temperature	2000K - 6500K (IP20) 2000K - 6000K (IP65/IP68)		
	Warm White (2000K)	Cool White (6500K)	All On
Power Consumption	3 W/ft (9.84 W/m)	3 W/ft (9.84 W/m)	6 W/ft (19.7 W/m)
Lumens	260.4 lm/ft (854.11 lm/m)	210.7 lm/ft (691.1 lm/m)	437.4 lm/ft (1434.67 lm/m)
Efficacy	87 lm/W	70 lm/W	73 lm/W
Current (mA) - 24V	250 mA/ft (820 mA/m)		
LED Pitch	42 LEDs/ft (140 LEDs/m)		
Protection Rating	IP20, IP65, IP68		
Dimming/Control	DMX / 0-10V with Dimming Module		
Operating Temperature	-40 - 140 °F (-40 - 60 °C) - IP20 -40 - 122 °F (-40 - 50 °C) - IP65/IP68		
MacAdam Ellipses (SDCM)	2-Step Binning		
Binning Tolerance	+/- 100K		
LED Beam Angle	120°		
Lifetime (L70 reported)	43,000 hrs @ 131 °F (55 °C)		
Cutable Length	1.97 in. (50 mm)		
Constant Voltage	✓		
Cable Length	12 in. (30.5 cm)		
Certifications	UL 2108 Issued: 2016/06/17 Ed: 1 Rev: 2021/10/16 Low Voltage Lighting Systems. CSA C22.2 No. 250.0, General Requirements for Luminaires. ROHS compliant CE		

\*2-Channel 0-10V Dimming maintains a consistent light output level while changing color temperatures.

24V DIMENSIONS	Top View	Side View	Dimensions
IP20	 CUTTABLE EVERY: 1.97 in. (50 mm)		Width 0.31 in. (8 mm) Max Length* 19 ft 8 in. (6 m) Height 0.09 in. (2.3 mm)
IP65	 CUTTABLE EVERY: 1.97 in. (50 mm)		Width 0.31 in. (8 mm) Max Length* 19 ft 8 in. (6 m) Height 0.125 in. (3.2 mm)
IP68	 CUTTABLE EVERY: 1.97 in. (50 mm)		Width 0.44 in. (11.2 mm) Max Length* 19 ft 8 in. (6 m) Height 0.18 in. (4.5 mm)

OPTIONAL ACCESSORY

0-10V Dimmable 90W VW/WD Driver	Flat Mounting Clip	Silicone Clip	0.5 in. VHB Tape**
 Part Number: DRVRFWDVW2490120	 For mounting IP20/IP65 RibbonLyte Part Number: RBMNTSIL	 For mounting IP68 RibbonLyte Part Number: RBMNTSILW	 Provides superior holding power in surface mounted applications Part Number: VHBTAPE0.5BK

**EXAMPLE:** When calculating supported loads with this module and 6.0 Variable White RibbonLyte (6.0 W/ft), you can divide the module's total rated power of 96W by half of the RibbonLyte's wattage per foot to get the total length supported.  $96 / 3 = 32$  ft of RibbonLyte.

\*\* RibbonLyte comes with an adhesive backing, but Acolyte recommends using VHB Tape for extra support in surface mounted applications.

Acolyte does not warrant or represent that the information is free from errors or omission. The information may change without notice and Acolyte is not in any way liable for the accuracy of any information printed and stored or in any way interpreted or used.



WIRING DIAGRAMS

2-CHANNEL VARIABLE WHITE DIMMING

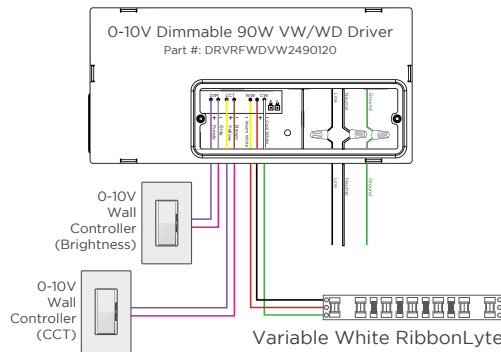

WIRE COLORS PER RIBBONLYTE COLOR

- VARIABLE WHITE**
- Black Wire (+) Positive
  - Red Wire (-) Warm Channel
  - Green Wire (-) Cool Channel

DMX WIRING DIAGRAM - COMPATIBLE WITH ALL MODELS OF VARIABLE WHITE RIBBONLYTE

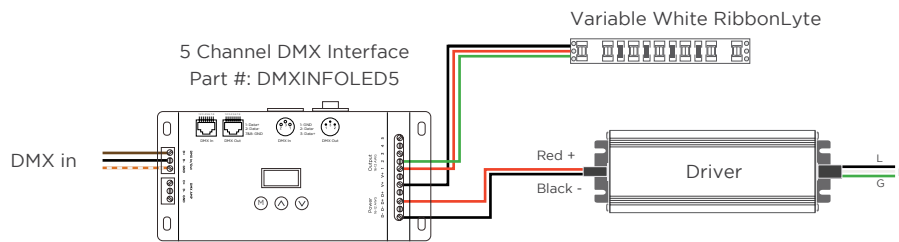

ACTUAL POWER CONSUMPTION

Length (ft)	Length (m)	Actual Power Consumed (W)	Average Wattage (W/ft)	Average Wattage (W/m)	Actual Current Drawn (A)
5	1.52	29.02	5.80	19.04	1.209
10	3.05	54.88	5.49	18.00	2.287
15	4.57	74.67	4.98	16.33	3.111
19.69	6.00	86.12	4.37	14.35	3.588

**NOTE:** Quotes use nominal values. We highly recommend using nominal wattages for all customer calculations. Allow for a 15% buffer (10% driver, 5% fixture) in these calculations as performance may vary. Acolyte is not liable for product performance if these tables are used instead of nominal values when orders are placed.

USAGE GUIDELINES

- IP65 and IP68 RibbonLyte cannot be cut in the field. All custom cuts and connections for these models must be performed at the factory to ensure waterproofing standards are met. Any modification of the waterproofing will result in a void warranty.
- When installing this product, consider the surface temperature of the material where it will be mounted. Many building surfaces which are exposed to direct sunlight exceed the 60 °C / 140 °F (IP20) and the 50 °C / 122 °F (IP65/IP68) maximum for which our products are rated. High-risk locations like this should be avoided.
- IP20 RibbonLyte products are for indoor use in dry areas. IP65 RibbonLyte products can be used in indoor dry/damp locations such as bathrooms and kitchens. IP68 RibbonLyte products can be used in wet, outdoor locations around pools and spa tubs, but our products are not intended to be submerged in pools and fountains and do not carry UL676 certification to do so.
- Please refer to the RibbonLyte Proper Usage Guide in our Application Guide for more information. Available for download at AcolyteLED.com.
- This product is compatible with a wide variety of control products including the entire line of Lutron dimming systems.
- For use with Acolyte drivers, 0-10V dimming modules and interface controllers (DMXINF models).
- Use with non-Acolyte supplied drivers is not supported or warrantied.
- Due to the nature of RibbonLyte products, cuttable lengths are generally longer or shorter than the customer requested length. Unless specified, RibbonLyte is factory cut at the shorter cuttable point.
- We reserve the right to make changes to product lineup, specifications, design and finishes at any time without notice.

REV.13JAN2025

**GLOBAL HQ**

320 Murray Hill Pkwy  
East Rutherford, NJ 07073  
U.S.  
T: (+1) 212 629 6830  
E: Sales-US@GENLEDBrands.com

**EUROPEAN HQ**

Hogeweyselaan 119  
1382 JK Weesp  
Netherlands  
T: (+31) 346 235 000  
E: SalesEurope@GENLEDBrands.com

**MEINA HQ**

PO Box 371378, #823, Building 4EA  
Dubai Airport Free Zone  
Dubai, UAE  
T: (+971) 4 701 7901  
E: SalesMEINA@genledbrands.com

**ASIA-PACIFIC HQ**

Room 402, Building D  
Shenshi Tongchuang Science and Technology Park  
No. 16 Hongyin Road  
Xingqiang Community, Xinhui Street  
Guangming District, Shenzhen, China 518107  
Sales: (+86) 139 1836 3905  
Office: (+86) 755 8529 0710  
E: Sales-Pacific@GENLEDBrands.com