



Date _____ Project _____

Notes _____

RGB DIRECT AC RIBBONLYTE

Acolyte's RGB Direct AC RibbonLyte extends up to 100 ft (30.48 m) on a single run with no drivers - perfect for long coves and other large spaces. It is factory cuttable every 1 foot (304.8 mm).

- Directly input 120 Volts AC
- Max run length: 100 ft (30.48 m)
- Red, Green, Blue (color changing)
- Factory cuttable every 1 ft (304.8 mm)
- IP65
- Dimmable and color tunable with DMX controller
- Mounting clips included (2 mounting clips per linear foot)
- 3.0 W/ft (9.8 W/m)
- All on: 32 lm/W
- All on: 95.6 lm/ft (313.57 lm/m)
- 1-year warranty



Applications:

Commercial	Hospitality	Residential
Entertainment	Museums	Retail
Healthcare	Public Spaces	



ORDERING GUIDE

Category	CRI	Ribbon Type & IP Rating	Wattage + Color
RB	0	AC12065	3.0RGB
RB - RibbonLyte	0 - Color Changing	AC12065 - Direct AC 120V IP65	3.0RGB - 3.0 W/ft (9.8 W/m) RGB

Connection Options:

2 meter cable to bare wire (6 ft 6.74 in.)
Part No.: RBACRGB2MI

8 meter cable to bare wire (26 ft 3 in.)
Part No.: RBACRGB8MI

6 cm jumper cable (2.4 in.)
Part No.: RBACRGB6CJ

30 cm jumper cable (11.81 in.)
Part No.: RBACRGB30CJ

4 meter jumper cable (13 ft 1.48 in.)
Part No.: RBACRGB4MJ

Included Accessories:

Mounting Clip
Part No.: RBOAC120RGBCLIP (2 clips per linear foot)

Optional Accessories:

Waterproof Cable Connector
Part No.: COUPT654BK (see page 4 for details)

High Voltage 4 Channel DMX Interface
Part No.: DMXINF120RGBW (see page 5 for details)

AVAILABLE COLOR TEMPERATURES



RGB

SPECIFICATIONS / DIMENSIONS / CHANNEL COMPATIBILITY

SPECIFICATIONS				
Operating Voltage	120 VAC			
Colors	RGB			
	Red (620-628 nm)	Green (525-531 nm)	Blue (470-475 nm)	All On
Power Consumption	1 W/ft (3.28 W/m)	1 W/ft (3.28 W/m)	1 W/ft (3.28 W/m)	3 W/ft (9.8 W/m)
Lumens	21.95 lm/ft (72 lm/m)	57.4 lm/ft (188.27 lm/m)	15.46 lm/ft (50.71 lm/m)	95.6 lm/ft (313.57 lm/m)
Efficacy	22 lm/W	57 lm/W	15 lm/W	32 lm/W
Current (mA)	25 mA/ft (82 mA/m)			
LED Pitch	36 LEDs/ft (120 LEDs/m)			
Protection Rating	IP65			
Dimming/Control	DMX			
Ambient Temperature	-4 – 113 °F (-20 – 45 °C)			
LED Beam Angle	150°			
Cutable Length	1 ft (304.8 mm) Please account for the 0.67 in. / 17 mm RibbonLyte inside of the power feed cap and end cap when calculating the total run length (add 1.34 in. / 34 mm for each run). See next page for details.			
Max Run length	100 ft (30.48 m)			
Cable Length	2 meter cable to bare wire (6 ft 6.74 in.); 8 meter cable to bare wire (26 ft 3 in.); 6 cm jumper cable (2.4 in.); 30 cm jumper cable (11.81 in.); 4 meter jumper cable (13 ft 1.48 in.)			
Certifications	ETL Listed			
Max Operating Temperature	113 °F (45 °C)			
Lifetime (L70 reported)	L70 > 36,000 hours at 131 °F (55 °C)			
Warranty	1-year warranty			

Dimensions	DIRECT AC RIBBONLYTE	MOUNTING CLIP Part #: RBOAC120RGBCLIP (includes 2 clips per foot)
		
Width	0.73 in. / 18.5 mm (end cap width: 0.88 in / 22 mm)	0.94 in. / 23.9 mm
Length	100 ft (30 m) max run length Factory cuttable every 1 ft (304.8 mm)	0.71 in. / 18.0 mm
Height	0.31 in. (8 mm)	0.48 in. / 12.2 mm

Acolyte does not warrant or represent that the information is free from errors or omission. The information may change without notice and Acolyte is not in any way liable for the accuracy of any information printed and stored or in any way interpreted or used.

DIAGRAMS

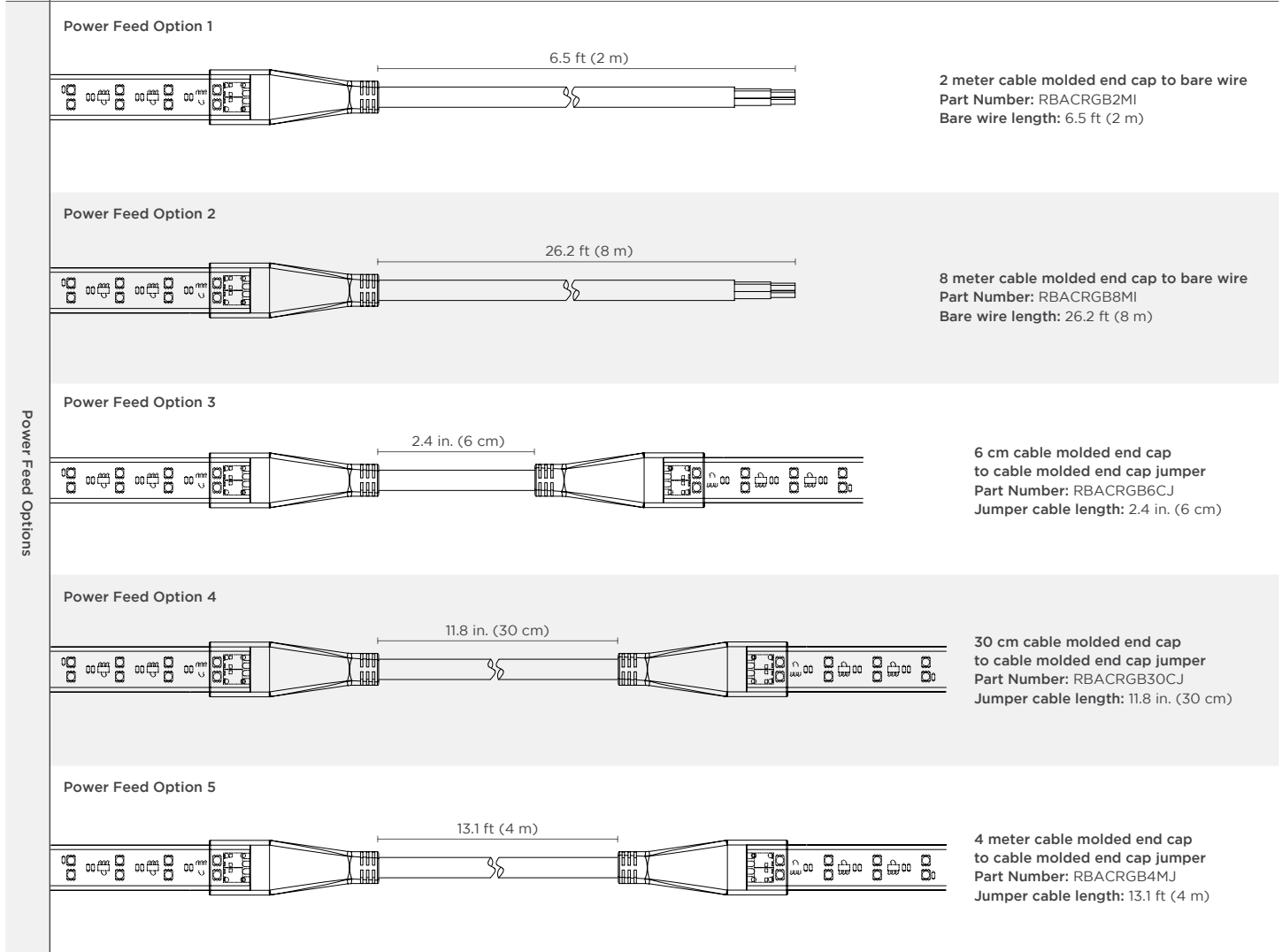
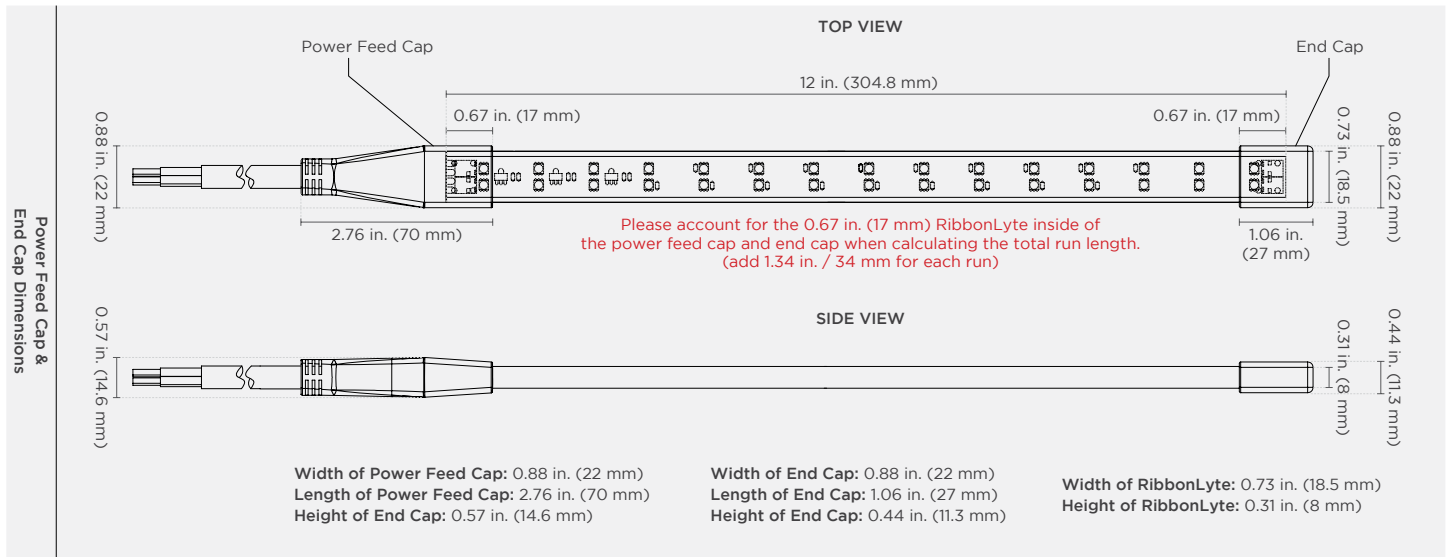

SPECIFICATIONS

We provide 2m and 8m power feed solutions. If additional length is needed use the cable coupler.

Part No. : COUPT654BK

Dimensions (Part Number: COUPT654BK)

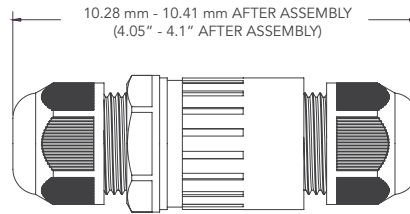
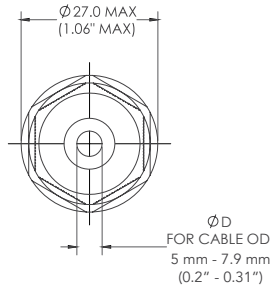

The Connector



Length: 4.05" - 4.10" After Assembly
Diameter: 1.06" MAX

Exploded View of the Connector

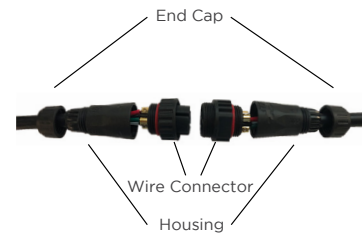

Step 1



Assemble cable from one end of the connector as shown above.

Step 2



Assemble cable from the other end of the connector as shown above. Make sure the wires go to their corresponding terminals (e.g. wire color matches to each other).

Step 3



Tighten two housings together and insert the rubber parts at the housing ends.

Step 4



Tighten two end caps.

USAGE GUIDELINES:

- IP65 RibbonLyte are not field cuttable. All custom cuts and connections for these models must be performed at the factory to ensure waterproofing standards are met. Any modification of this on the field or by end user will result in a voided warranty.
- When installing this product take into account the surface temperature of the material this product is mounted to. Many building surfaces exceed the 45° C / 113° F maximum that our product is rated for. High-risk locations like this should be avoided. Avoid direct sunlight.
- This product is not intended to be submerged in pools and fountains and do not carry UL676 certification to do so.
- Please refer to our RibbonLyte Proper Use Guide in our *Application Guide* for more information. Available for download at www.GENLEDBrands.com/Acolyte
- Compatible with a wide variety of control products including the entire line of Lutron dimming systems.
- For use with Acolyte drivers, 0-10V dimming modules and interface controllers (DMXINF models).
- Use with non-Acolyte supplied Triac, MLV or ELV drivers is not supported or warranted.
- Due to the nature of the product, RibbonLyte cuttable lengths are generally longer or shorter than the customer requested length. Unless specified, RibbonLyte is factory cut at the shorter cuttable point.
- We reserve the right to make changes to product lineup, specifications, design and finishes at any time without notice.

DIMMING SYSTEM WIRING DIAGRAM

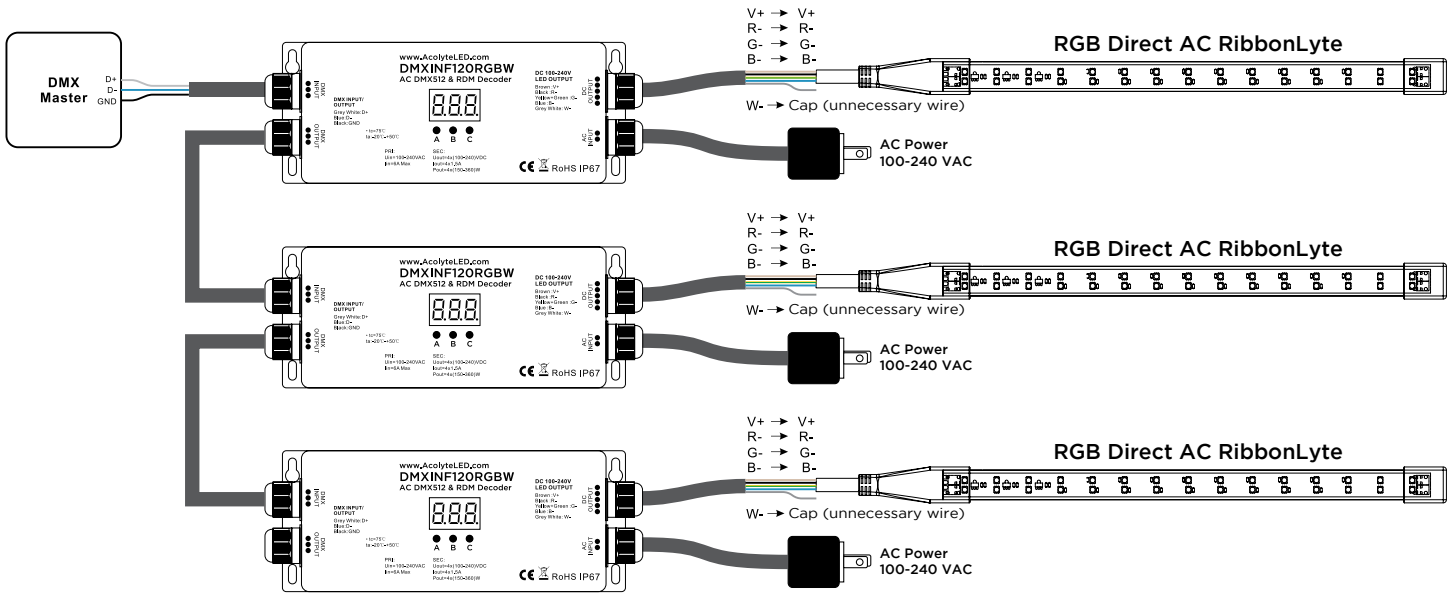

High Voltage 4 Channel DMX Interface

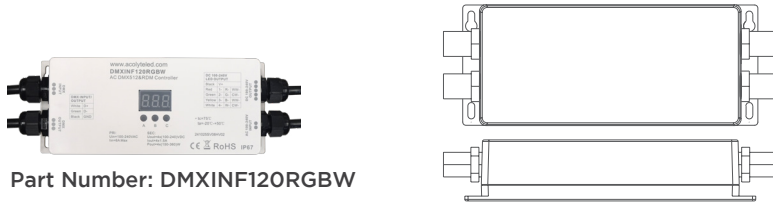

Part Number: DMXINFIN20RGBW

Width: 2.9 in (73.6 mm)
Length: 7.1 in (180.5 mm)
Depth: 1.5 in (38 mm)

REV09APR2026

GLOBAL HQ
320 Murray Hill Pkwy
East Rutherford, NJ 07073
U.S.
T: (+1) 212 629 6830
E: Sales-US@GENLEDBrands.com

EUROPEAN HQ
Hogeweyselaan 119
1382 JK Weesp
Netherlands
T: (+31) 346 235 000
E: SalesEurope@GENLEDBrands.com

MEINA HQ
PO Box 371378, #823, Building 4EA
Dubai Airport Free Zone
Dubai, UAE
T: (+971) 4 701 7901
E: SalesMEINA@genledbrands.com

ASIA-PACIFIC HQ
Room 402, Building D
Shensi Tongchuang Science and Technology Park
No. 16 Hongyin Road
Xingqiang Community, Xinhu Street
Guangming District, Shenzhen, China 518107
T: (+86) 755 8529 0710
E: Sales-Pacific@GENLEDBrands.com