



Date _____ Project _____

Notes _____

STATIC COLOR MICRO RIBBONLYTE 1.0

We've introduced our Micro RibbonLyte for creating unique visual effects and precision lighting in tight spaces. It's designed to fit into our new AS7, AR7, AS9, and AR9 channels. At 1.0 W/ft (3.3 W/m), the IP20 and IP65 versions of this tape are only 0.20 in. (5 mm) wide.

- 0.20 in. width (5 mm)
- Fits in 0.30 in. wide channel (7.60 mm)
- 5 colors: red, amber, green, blue, and violet
- Closet rated in channel applications



Applications:

Commercial	Hospitality	Residential
Entertainment	Museums	Retail
Healthcare	Public Spaces	



ORDERING GUIDE

Category	CRI	Ribbon Type & IP Rating	Wattage & Color	
RB	0			
RB - RIBBONLYTE	0 - Static Colors	SCMC20 - Micro Static Color IP20 SCMC65 - Micro Static Color IP65	1.0R - 1.0 W/ft Red 1.0G - 1.0 W/ft Green 1.0B - 1.0 W/ft Blue	1.0A - 1.0 W/ft Amber 1.0V - 1.0 W/ft Violet

CONNECTION OPTIONS

1. End Feed Bare Wire Connection (Default Option)



2. IP67 Connector Input



3. Soldered Daisy Chain



4. Daisy Chain with IP67 Connectors



5. Bare Wire on Both Ends



Standard cable length if not specified:

1. 12 in. cable with bare wire (custom length up to 20 feet)
2. Standard 12 in. cable with IP67 connectors (custom length up to 10 feet)
3. Daisy chain with 3 in. cable between runs (custom length up to 36 in.)
4. 3 in. cable between IP67 connector and RibbonLyte (custom length up to 18 in.)
5. Standard 12 in. cable with bare wire (custom length up to 10 feet)





Note: IP67 connectors are used for both IP20 and IP65/IP68 RibbonLyte

AVAILABLE COLORS



SPECIFICATIONS / DIAGRAM / USAGE GUIDELINES

STATIC COLOR MICRO RIBBONLYTE 1.0					
Operating Voltage	24 V				
Power Consumption	1.0 W/ft (3.3 W/m)				
Current (mA) - 24V	41.7 mA/ft (137 mA/m)				
LED Pitch	43 LEDs/ft (140 LEDs/m)				
Protection Rating	IP20, IP65				
Dimming/Control	ELV / MLV / 0-10 Volt / DMX / DALI				
Operating Temperature	-40° F to 158° F (-40° C to 70° C)				
Colors	Red	Amber	Green	Blue	Violet
Lumens	27 lm/ft (88 lm/m)	19 lm/ft (61 lm/m)	78 lm/ft (256 lm/m)	17 lm/ft (56 lm/m)	1 lm/ft (3 lm/m)
LED Beam Angle	120°				
Lamp Life	50,000 Hrs				
Cutable Length	1.97 in (50 mm)				
Constant Voltage	✓				
Lumens / Watt	27 lm/W	19 lm/W	78 lm/W	17 lm/W	1 lm/W
Certifications	UL 2108 Issued: 2016/06/17 Ed: 1 Rev: 2021/10/16 Low Voltage Lighting Systems. CSA C22.2 No. 250.0, General Requirements for Luminaires. RoHS compliant. All RibbonLyte models 3.0 W/ft (9.8 W/m) and lower when used in any Acolyte Channel profile except Piccolo are tested by UL and confirmed 'Suitable for Installation in the Storage Area of a Clothes Closet' in accordance with NFPA 70 and NEC 410.16 and 411.				
Warranty	IP20: 6 years, IP65: 3 years				

24V DIMENSIONS	Top View	Side View	Dimensions
IP20	 CUTTABLE EVERY: 1.97 in (50 mm)		Width 0.20 in (5 mm) Max Length* 28 ft (8.5 m) Height 0.06 in (1.45 mm)
IP65	 CUTTABLE EVERY: 1.97 in (50 mm)		Width 0.20 in (5 mm) Max Length* 28 ft (8.5 m) Height 0.1 in (2.5 mm)

OPTIONAL ACCESSORY

0.5 in. VHB Tape	Flat Mounting Clip
 <p>Provides superior holding power in surface mounted applications Part Number: VHBTAPE0.5BK</p>	 <p>For mounting IP20/IP65 RibbonLyte Part Number: RBMNTSIL</p>



Note: RibbonLyte comes with an adhesive backing, but Acolyte recommends using VHB Tape for extra support in surface mounted applications.



USAGE GUIDELINES

- IP65 and IP68 RibbonLyte cannot be cut in the field. All custom cuts and connections for these models must be performed at the factory to ensure waterproofing standards are met. Any modification of the waterproofing will result in a void warranty.
- When installing this product, consider the surface temperature of the material where it will be mounted. Many building surfaces which are exposed to direct sunlight exceed the 70° C / 158° F maximum for which our product is rated. High-risk locations like this should be avoided.
- IP20 RibbonLyte products are for indoor use in dry areas. IP65 RibbonLyte products can be used in indoor dry/damp locations such as bathrooms and kitchens. IP68 RibbonLyte products can be used in wet, outdoor locations around pools and spa tubs, but our products are not intended to be submerged in pools and fountains and do not carry UL676 certification to do so.
- Please refer to the RibbonLyte Proper Usage Guide in our Application Guide for more information. Available for download at AcolyteLED.com.
- This product is compatible with a wide variety of control products including the entire line of Lutron dimming systems.
- For use with Acolyte drivers, 0-10V dimming modules and interface controllers (DMXINF models).
- Use with non-Acolyte supplied drivers is not supported or warrantied.
- Due to the nature of RibbonLyte products, cuttable lengths are generally longer or shorter than the customer requested length. Unless specified, RibbonLyte is factory cut at the shorter cuttable point.
- We reserve the right to make changes to product lineup, specifications, design and finishes at any time without notice.

Acolyte does not warrant or represent that the information is free from errors or omission. The information may change without notice and Acolyte is not in any way liable for the accuracy of any information printed and stored or in any way interpreted or used.

CHANNEL COMPATIBILITY / CHANNEL OPTIONS

	IP20/IP65	SURFACE CHANNELS	
AS7	✓		
AR7	✓		
AS9	✓		
AR9	✓		

RECESSED CHANNELS	
	
AR7	AR9
W: 0.63 in. / 16.1 mm H: 0.59 in. / 15 mm Inside W: 0.33 in. / 8.5 mm	W: 0.54 in. / 13.6 mm H: 0.35 in. / 8.9 mm Inside W: 0.22 in. / 5.7 mm

WIRING DIAGRAMS

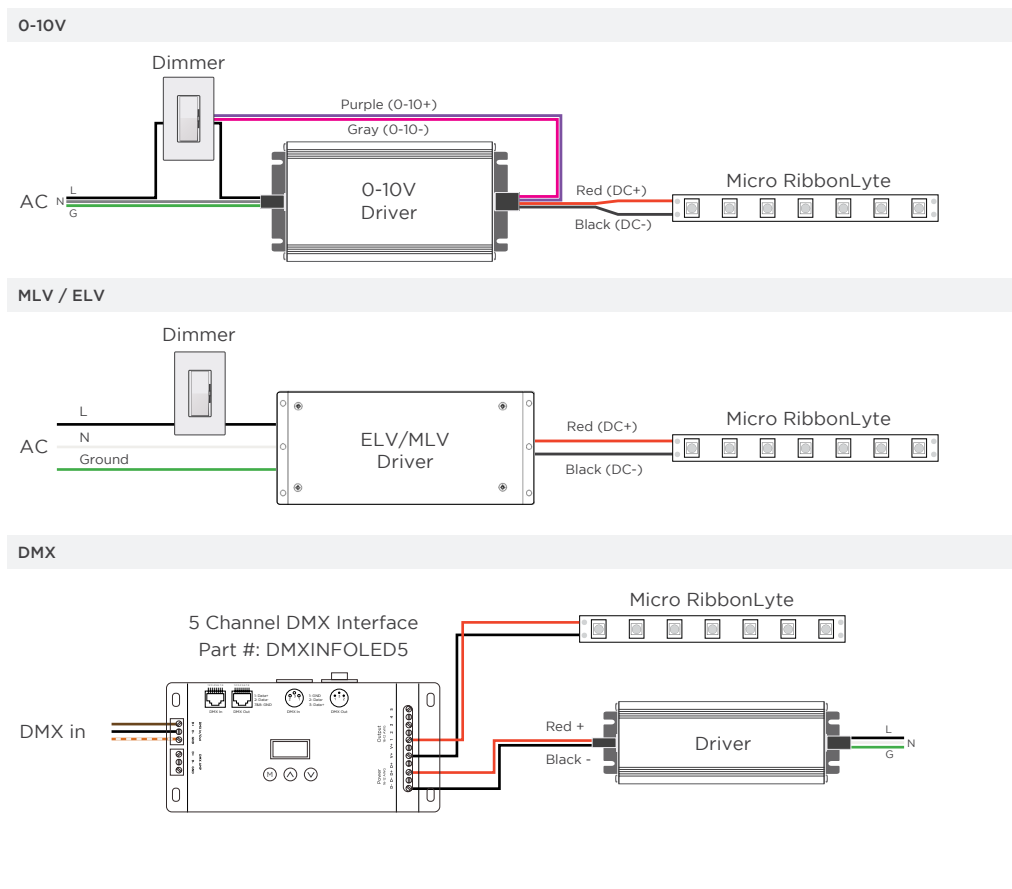

WIRE COLORS PER RIBBONLYTE COLOR

STATIC COLOR MICRO
Red Wire (+) Positive
Black Wire (-) Negative

DISCLAIMER

When installing this product take into account the surface temperature of the material this product is mounted to. Many building surfaces which are exposed to direct sunlight exceed the 70°C/158°F maximum that our product is rated for. High risk locations like this should be avoided. Our IP68 product is not intended to be submerged in pools and fountains and does not carry UL676 certification to do so.