

**SIMPLY CLEAN™ RECESSED FIXTURES SC4**

Simply Clean™ SC4 channel lets you build custom recessed fixtures with our RibbonLyte products. Display stunning seamless continuous lines of light flush to new or existing drywall or gypsum walls and ceilings.

- 2.5 in. (63.4 mm) wide by 0.63 in. (15.9 mm) deep
- Beam angle: 110°
- Wattage Range from 0.75 W/ft (2.46 W/m) to 12 W/ft (39.4 W/m)
- Static White delivered lumen range from 44 lm/ft (145 lm/m) up to 1246 lm/ft (4087 lm/m)
- Milky or Black lens
- For interior applications only

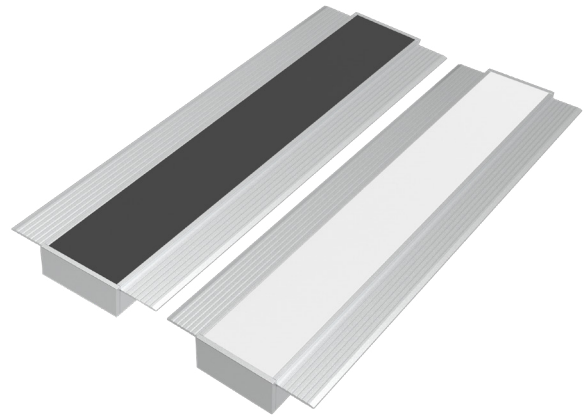

**HOUSING FINISHES**



Silver

**LENS FINISHES**



Milky Lens

75% Light Transmission



Black Lens\*\*

70% Light Transmission

\*\*Our black lens offers great diffusion and helps hide fixtures that aren't in use.



RoHS IP20



**AVAILABLE COLORS & COLOR TEMPERATURES**

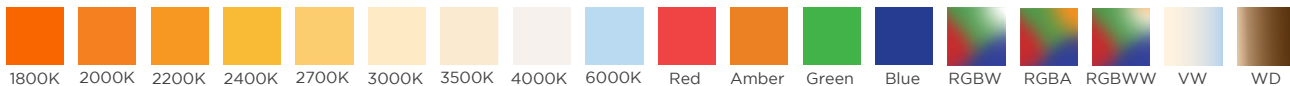

**DIMENSIONS**

**SC4 Channel**

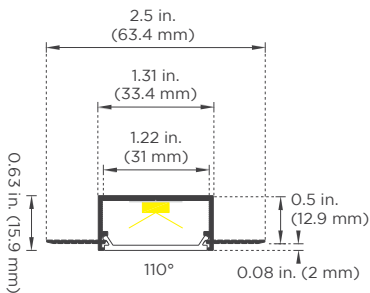

**Width:** 2.5 in. (63.4 mm)  
**Height:** 0.63 in. (15.9 mm)  
**Internal Width:** 1.22 in. (31 mm)  
**Internal Height:** 0.5 in. (12.9 mm)

**MOUNTING OPTIONS:**



Ceiling Mount



Vertical Wall Mount

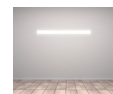

Horizontal Wall Mount

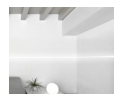

Cross-Wall Mount

**Note:** This channel does not require mounting clips. Please see our installation guide for instructions.

Acolyte does not warrant or represent that the information is free from errors or omission. The information may change without notice and Acolyte is not in any way liable for the accuracy of any information printed and stored or in any way interpreted or used.

**SPECIFICATIONS**

<b>Beam Angle</b>	110°
<b>Lens Type</b>	Milky Lens, Black Lens
<b>Length</b>	Channel is sold by the foot and cut to your exact desired length
<b>Operating Voltage</b>	24V
<b>Dimming</b>	MLV / 0-10 Volt / ELV / DALI / DMX
<b>Operating Temperature</b>	-40° F to 158° F (-40° C to 70° C)
<b>Colors</b>	1800K, 2000K, 2200K, 2400K, 2700K, 3000K, 3500K, 4000K, 6000K, Red, Amber, Green, Blue, RGBA, RGBW, RGBWW, VW, RGBW Addressable, Warm Dim (1800K, 2000K, 2200K only available in IP20)
<b>CRI</b>	90+ CRI (Static white only)
<b>Lamp Life</b>	L70 at 50,000 Hours
<b>MacAdam Ellipses (SDCM)</b>	2-Step Binning (For Static White LEDs only)
<b>Certifications</b>	UL Listed UL 2108 Issued: 2004/02/27 Ed: 1 Rev: 2014/02/24 Low Voltage Lighting Systems CSA C22.2#9.0 Issued: 1996/06/01 Ed: 1 (R2011) General Requirements for Luminaires; with Gen. Inst. 1: 1997, Gen Inst. 2: 1998. ROHS compliant

**ACCESSORIES**

End Cap

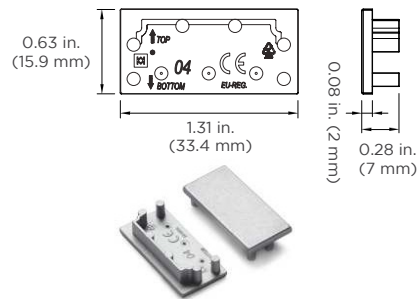

**STEP 1** Complete Channel Part Number

CHANNEL	LENS	HOUSING COLOR
<b>CHSC4</b>		<b>SV</b>
CHSC4 - SC4 Channel	M - Milky Lens BK - Black Lens	SV - Silver

**STEP 2** Complete RibbonLyte Part Number

CATEGORY	CRI	RIBBON TYPE & IP RATING		
<b>RB</b>				
RB - RibbonLyte	0 - Static Color, Color Changing	<b>LINEA20</b> - Linea RibbonLyte IP20	<b>RGBW20</b> - RGBWW 5-in-1 IP20	<b>VWS220</b> - VW Series 2 IP20
	90 - 90+ CRI Static White	<b>SWS220</b> - Static White Series 2 IP20	<b>RGBWS220</b> - RGBW Series 2 IP20	<b>VWS265</b> - VW Series 2 IP65
		<b>SWS265</b> - Static White Series 2 IP65	<b>RGBWS265</b> - RGBW Series 2 IP65	<b>VWS268</b> - VW Series 2 IP68
		<b>SWS268</b> - Static White Series 2 IP68	<b>RGBWS268</b> - RGBW Series 2 IP68	<b>WD20</b> - Warm Dim IP20
		<b>SWDR20</b> - Static White Double Row IP20	<b>RGBWADD</b> - Addressable RGBW IP67	<b>WD65</b> - Warm Dim IP65
		<b>SCS220</b> - Static Color Series 2 IP20	<b>RGBWADR20</b> - RGBW/A Double Row IP20	<b>WD68</b> - Warm Dim IP68
		<b>SCS265</b> - Static Color Series 2 IP65	<b>VWDR20</b> - Variable White Double Row IP20	
		<b>SCS268</b> - Static Color Series 2 IP68		

**NOTE:** To ensure waterproofing standards are met, IP65, IP67, and IP68 RibbonLyte can NOT be cut in the field.

**WATTAGE**

- 0.75 - 0.75 W/ft (2.46 W/m - Static White, Static Color)
- 1.0 - 1.0 W/ft (3.3 W/m - Variable White)
- 1.5 - 1.5 W/ft (4.9 W/m - Static White, Static Color)
- 2.2 - 2.2 W/ft (7.2 W/m - Static White, Static Color)
- 2.4 - 2.4 W/ft (8 W/m - Static White)
- 3.0 - 3.0 W/ft (9.8 W/m - Static White, Static Color, Variable White, RGBW, RGBA)
- 4.3 - 4.3 W/ft (14 W/m - Static White)
- 4.4 - 4.4 W/ft (14.4 W/m - Static White, Static Color, RGBW, RGBWW, RGBA)
- 5.0 - 5.0 W/ft (16.4 W/m - Static White, Static Color)
- 5.2 - 5.2 W/ft (17.1 W/m - Warm Dim)
- 5.5 - 5.5 W/ft (18.0 W/m - RGBW, RGBA)
- 6.0 - 6.0 W/ft (19.7 W/m - Static White, Static Color, Variable White, RGBW, RGBA, RGBW Addressable)
- 6.1 - 6.1 W/ft (20 W/m - Variable White)
- 8.8 - 8.8 W/ft (28.9 W/m - RGBW, RGBWW, RGBA)
- 12.0 - 12.0 W/ft (39.4 W/m - Static White, Variable White, RGBW, RGBA)

**COLOR**

- 18 - 1800K **VW** - Variable White
- 20 - 2000K **RGB27** - Red, Green, Blue + 2700K
- 22 - 2200K **RGB30** - Red, Green, Blue + 3000K
- 24 - 2400K **RGB40** - Red, Green, Blue + 4000K
- 27 - 2700K **RGB2465** - Red, Green, Blue + 2400K + 6500K
- 30 - 3000K **RGBA** - Red, Green, Blue + Amber
- 35 - 3500K **RGBW30** - RGB + 3000K Addressable
- 40 - 4000K **RGBW40** - RGB + 4000K Addressable
- 60 - 6000K **RGBW60** - RGB + 6000K Addressable
- R - Red **2920** - Warm Dim 2900K - 2000K (IP20)
- A - Amber **2721** - Warm Dim 2700K - 2100K (IP65+IP68)
- G - Green **Z** - Undecided\*\*
- B - Blue **\*\*** For quotes only. Must be chosen before final order.

**CONNECTION OPTIONS** (See diagrams on the right)

- 1 - End Feed Bare Wire Connection
- 2 - Back Feed Bare Wire Connection
- 3 - Side Feed Bare Wire Connection
- 4 - End Feed with IP67 Male Coupler
- 5 - Soldered Daisy Chain
- 6 - Daisy Chain With IP67 Couplers

**Custom Length (ft.)**

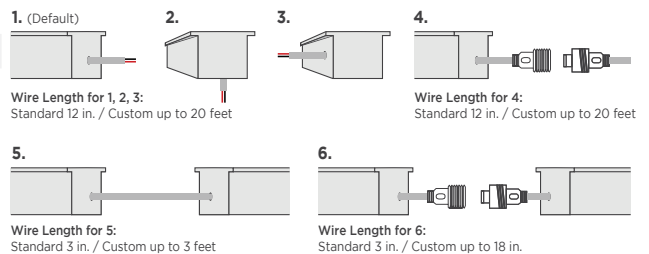

RIBBONLYTE SPECIFICATIONS & COMPATIBILITY

Available Wattage	Cutttable Length	LED Pitch	Color Temp.	lm/W without Lens	Delivered Lumens with Milky Lens (lm/ft / lm/m)	Delivered Lumens with Black Lens (lm/ft / lm/m)	Max Length	Compatible with Channel		
								IP20	IP65	IP68
0.75 Static White Series 2	1.97 in. (50 mm)	48 LEDs/ft (160 LEDs/m)	1800K	84	47 / 155	44 / 145	IP20: 49 ft (15 m) IP65/IP68: 32.8 ft (10 m)	✓	✓	✓
			2000K	99	56 / 183	52 / 171				
			2200K	109	61 / 201	57 / 188				
			2400K	113	64 / 209	59 / 195				
			2700K	123	69 / 227	65 / 212				
			3000K	123	69 / 227	65 / 212				
			3500K	130	73 / 240	68 / 224				
			4000K	134	75 / 247	70 / 231				
			6000K	131	74 / 242	69 / 226				
1.5 Static White Series 2	1.97 in. (50 mm)	48 LEDs/ft (160 LEDs/m)	1800K	84	95 / 310	88 / 289	IP20: 49 ft (15 m) IP65/IP68: 32.8 ft (10 m)	✓	✓	✓
			2000K	98	110 / 362	103 / 338				
			2200K	109	123 / 402	114 / 375				
			2400K	113	127 / 417	119 / 389				
			2700K	123	138 / 454	129 / 424				
			3000K	123	138 / 454	129 / 424				
			3500K	129	145 / 476	135 / 444				
			4000K	134	151 / 495	141 / 462				
			6000K	131	147 / 484	138 / 451				
2.2 Static White Series 2	1.97 in. (50 mm)	48 LEDs/ft (160 LEDs/m)	1800K	83	137 / 449	128 / 419	IP20: 42 ft (12.8 m) IP65/IP68: 32.8 ft (10 m)	✓	✓	✓
			2000K	96	158 / 520	148 / 485				
			2200K	106	175 / 574	163 / 536				
			2400K	111	183 / 601	171 / 561				
			2700K	120	198 / 650	185 / 606				
			3000K	122	201 / 660	188 / 616				
			3500K	127	210 / 687	196 / 642				
			4000K	133	219 / 720	205 / 672				
			6000K	128	211 / 693	197 / 647				
3.0 Static White Series 2	1.97 in. (50 mm)	48 LEDs/ft (160 LEDs/m)	1800K	84	189 / 620	176 / 579	IP20: 36 ft (11 m) IP65/IP68: 32.8 ft (10 m)	✓	✓	✓
			2000K	98	221 / 723	206 / 675				
			2200K	108	243 / 797	227 / 744				
			2400K	109.8	247 / 811	231 / 756				
			2700K	122.9	277 / 907	258 / 847				
			3000K	130	293 / 960	273 / 896				
			3500K	133	299 / 982	279 / 916				
			4000K	133	299 / 982	279 / 916				
			6000K	128	288 / 945	269 / 882				
4.4 Static White Series 2	1.97 in. (50 mm)	48 LEDs/ft (160 LEDs/m)	1800K	81	267 / 877	249 / 818	28 ft 4 in. (8.64 m)	✓	✓	✓
			2000K	95	314 / 1029	293 / 960				
			2200K	105	347 / 1137	323 / 1061				
			2400K	109	360 / 1180	336 / 1101				
			2700K	122	403 / 1321	376 / 1233				
			3000K	129	426 / 1397	397 / 1304				
			3500K	132	436 / 1429	407 / 1334				
			4000K	132	436 / 1429	407 / 1334				
			6000K	126	416 / 1364	388 / 1273				
5.0 Static White Series 2	1.4 in. (35.7 mm)	68 LEDs/ft (224 LEDs/m)	1800K	83	311 / 1021	291 / 953	IP20: 33 ft 4 in. (10.1 m) IP65/IP68: 32.8 ft (10 m)	✓	✓	✓
			2000K	98	368 / 1206	343 / 1125				
			2200K	107	401 / 1316	375 / 1229				
			2400K	110	412 / 1351	384 / 1261				
			2700K	123	461 / 1512	430 / 1411				
			3000K	130	488 / 1599	455 / 1493				
			3500K	133	499 / 1636	466 / 1527				
			4000K	133	499 / 1636	466 / 1527				
			6000K	127	476 / 1562	445 / 1458				
6.0 Static White Series 2	1.4 in. (35.7 mm)	68 LEDs/ft (224 LEDs/m)	1800K	82	369 / 1211	344 / 1130	28 ft (8.5 m)	✓	✓	✓
			2000K	95	428 / 1403	399 / 1309				
			2200K	106	477 / 1565	445 / 1461				
			2400K	109	491 / 1609	458 / 1502				
			2700K	122	549 / 1801	512 / 1681				
			3000K	129	581 / 1905	542 / 1778				
			3500K	132	594 / 1949	554 / 1819				
			4000K	132	594 / 1949	554 / 1819				
			6000K	126	567 / 1860	529 / 1736				

RIBBONLYTE SPECIFICATIONS & COMPATIBILITY

Available Wattages	Cuttable Length	LED Pitch	Color Temp.	lm/W without Lens	Delivered Lumens with Milky Lens (lm/ft / lm/m)	Delivered Lumens with Black Lens (lm/ft / lm/m)	Max Length	Compatible with Channel		
								IP20	IP65	IP68
3.0 Static White Double Row	0.7 in. (17.9 mm)	136 LEDs/ft (448 LEDs/m)	1800K	73	202 / 662	153 / 504	65 ft 7 in. (20 m)	✓	N/A	N/A
			2000K	86	238 / 781	181 / 595				
			2200K	94	260 / 853	198 / 649				
			2400K	97	267 / 877	203 / 667				
			2700K	109	301 / 989	229 / 752				
			3000K	118	326 / 1069	248 / 813				
			3500K	119	328 / 1077	250 / 819				
			4000K	118	326 / 1069	248 / 813				
6.0 Static White Double Row	0.7 in. (17.9 mm)	136 LEDs/ft (448 LEDs/m)	1800K	73	403 / 1324	307 / 1007	39 ft (12 m)	✓	N/A	N/A
			2000K	86	476 / 1563	362 / 1189				
			2200K	94	520 / 1707	396 / 1298				
			2400K	97	535 / 1754	407 / 1335				
			2700K	109	603 / 1978	459 / 1505				
			3000K	118	651 / 2137	496 / 1626				
			3500K	119	656 / 2153	499 / 1638				
			4000K	118	651 / 2137	496 / 1626				
12.0 Static White Double Row	0.7 in. (17.9 mm)	136 LEDs/ft (448 LEDs/m)	1800K	69	766 / 2513	583 / 1912	26 ft 3 in. (8 m)	✓	N/A	N/A
			2000K	82	904 / 2967	688 / 2257				
			2200K	89	987 / 3239	751 / 2465				
			2400K	92	1015 / 3330	772 / 2534				
			2700K	104	1144 / 3754	871 / 2856				
			3000K	112	1236 / 4057	941 / 3087				
			3500K	113	1246 / 4087	948 / 3110				
			4000K	112	1236 / 4057	941 / 3087				
0.75 Static Color Series 2	1.97 in. (50 mm)	48 LEDs/ft (160 LEDs/m)	Red	41	23 / 76	22 / 71	IP20: 49 ft (15 m) IP65/IP68: 32.8 ft (10 m)	✓	✓	✓
			Green	175	98 / 323	92 / 301				
			Blue	19	11 / 35	10 / 33				
			Amber	34	19 / 63	18 / 59				
1.5 Static Color Series 2	1.97 in. (50 mm)	48 LEDs/ft (160 LEDs/m)	Red	42	47 / 155	44 / 145	IP20: 49 ft (15 m) IP65/IP68: 32.8 ft (10 m)	✓	✓	✓
			Green	160	180 / 591	168 / 551				
			Blue	18	20 / 66	19 / 62				
			Amber	34	38 / 125	36 / 117				
2.2 Static Color Series 2	1.97 in. (50 mm)	48 LEDs/ft (160 LEDs/m)	Red	42	69 / 227	65 / 212	IP20: 42 ft (12.8 m) IP65/IP68: 32.8 ft (10 m)	✓	✓	✓
			Green	145	239 / 785	223 / 733				
			Blue	18	30 / 97	28 / 91				
			Amber	34	56 / 184	52 / 172				
3.0 Static Color Series 2	1.97 in. (50 mm)	48 LEDs/ft (160 LEDs/m)	Red	40	90 / 295	84 / 267	32.8 ft (10 m)	✓	✓	✓
			Green	127	286 / 937	267 / 875				
			Blue	25	56 / 185	53 / 172				
			Amber	29	65 / 214	61 / 200				
4.4 Static Color Series 2	1.97 in. (50 mm)	48 LEDs/ft (160 LEDs/m)	Red	38	125 / 411	117 / 384	29 ft (8.8 m)	✓	✓	✓
			Green	117	386 / 1267	360 / 1182				
			Blue	24	79 / 260	74 / 243				
			Amber	25	83 / 271	77 / 253				

RIBBONLYTE SPECIFICATIONS & COMPATIBILITY

Available Wattages	Cutttable Length	LED Pitch	Color Temp.	lm/W without Lens	Delivered Lumens with Milky Lens (lm/ft / lm/m)	Delivered Lumens with Black Lens (lm/ft / lm/m)	Max Length	Compatible with Channel		
								IP20	IP65	IP68
5.0 Static Color Series 2	1.4 in. (35.7 mm)	68 LEDs/ft (224 LEDs/m)	Red	37	139 / 455	130 / 425	30 ft (9.14 m)	✓	✓	✓
			Green	116	435 / 1427	406 / 1332				
			Blue	24	90 / 295	84 / 276				
			Amber	26	98 / 320	91 / 299				
6.0 Static Color Series 2	1.4 in. (35.7 mm)	68 LEDs/ft (224 LEDs/m)	Red	37	167 / 546	155 / 510	28 ft (8.5 m)	✓	✓	✓
			Green	113	509 / 1668	475 / 1557				
			Blue	23	104 / 340	97 / 317				
			Amber	24	108 / 354	101 / 331				
2.4 Static White Linea	1.97 in. (50 mm)	146 LEDs/ft (480 LEDs/m)	2700K	67	120.8 / 396	112.7 / 369.6	21.3 ft (6.5 m)	✓	N/A	N/A
			3000K	71	127.5 / 419.3	119 / 391.3				
			3500K	83	149.3 / 490.5	139.3 / 457.8				
			4000K	83	149.3 / 490.5	139.3 / 457.8				
3.0 Static White Linea	1.97 in. (50 mm)	146 LEDs/ft (480 LEDs/m)	2700K	66	148.5 / 487.5	138.6 / 455	21.3 ft (6.5 m)	✓	N/A	N/A
			3000K	73	164.3 / 539.3	153.3 / 503.3				
			3500K	78	175.5 / 576	163.8 / 537.6				
			4000K	83	186.8 / 612.8	174.3 / 571.9				
4.3 Static White Linea	1.97 in. (50 mm)	146 LEDs/ft (480 LEDs/m)	2700K	75	242.3 / 793.5	226.1 / 740.6	24.6 ft (7.5 m)	✓	N/A	N/A
			3000K	78	251.3 / 825	234.5 / 770				
			3500K	86	277.5 / 910.5	259 / 849.8				
			4000K	86	277.5 / 910.5	259 / 849.8				
6.1 Variable White Linea	1.09 in. (27.78 mm)	175 LEDs/ft (576 LEDs/m)	2700K + 6500K	95	435 / 427.3	406 / 332.1	16.4 ft (5 m)	✓	N/A	N/A
1.0 Variable White Series 2	1.97 in. (50 mm)	42 LEDs/ft (140 LEDs/m)	2000K + 6500K	85	64 / 209	60 / 195	32.8 ft (10 m)	✓	✓	✓
3.0 Variable White Series 2	1.97 in. (50 mm)	42 LEDs/ft (140 LEDs/m)	2000K + 6500K	80	180 / 591	168 / 551	32.8 ft (10 m)	✓	✓	✓
6.0 Variable White Series 2	1.97 in. (50 mm)	42 LEDs/ft (140 LEDs/m)	2000K + 6500K	75	338 / 1107	315 / 1033	19 ft 8 in. (6 m)	✓	✓	✓
3.0 Variable White Double Row	1.97 in. (50 mm)	84 LEDs/ft (280 LEDs/m)	2000K + 6500K	87	240 / 788	183 / 599	65 ft 7 in. (20 m)	✓	N/A	N/A
6.0 Variable White Double Row	1.97 in. (50 mm)	84 LEDs/ft (280 LEDs/m)	2000K + 6500K	82	453 / 1485	344 / 1130	45 ft 11 in. (14 m)	✓	N/A	N/A
12.0 Variable White Double Row	1.97 in. (50 mm)	84 LEDs/ft (280 LEDs/m)	2000K + 6500K	71	784 / 2572	596 / 1957	22 ft 11 in. (7 m)	✓	N/A	N/A
4.4 RGBW Series 2	1.97 in. (50 mm)	36 LEDs/ft (120 LEDs/m)	RGBW	45	148.5 / 487.2	138.6 / 454.7	19 ft 8 in. (6 m)	✓	N/A	N/A
5.5 RGBW Series 2	1.97 in. (50 mm)	36 LEDs/ft (120 LEDs/m)	RGBW	59	243.3 / 798.5	227.2 / 745.3	IP65: 16 ft 4 in. (5 m) IP 68: 19 ft 7.9 in. (6 m)	N/A	✓	✓
8.8 RGBW Series 2	1.97 in. (50 mm)	36 LEDs/ft (120 LEDs/m)	RGBW	61	402.6 / 1320.9	375.8 / 1232.9	16 ft 4 in. (5 m)	✓	N/A	N/A

RIBBONLYTE SPECIFICATIONS & COMPATIBILITY

Available Wattages	Cuttable Length	LED Pitch	Color Temp.	lm/W without Lens	Delivered Lumens with Milky Lens (lm/ft / lm/m)	Delivered Lumens with Black Lens (lm/ft / lm/m)	Max Length	Compatible with Channel		
								IP20	IP65	IP68
3.0 RGBW Double Row	1.3 in. (33 mm)	72 LEDs/ft (240 LEDs/m)	RGBW	91	251 / 824	191 / 627	26 ft 3 in. (8 m)	✓	N/A	N/A
3.0 RGBA Double Row	1.3 in. (33 mm)	72 LEDs/ft (240 LEDs/m)	RGBA	78	251 / 824	191 / 627	26 ft 3 in. (8 m)	✓	N/A	N/A
6.0 RGBW Double Row	1.3 in. (33 mm)	72 LEDs/ft (240 LEDs/m)	RGBW	91	502 / 1648	382 / 1254	22 ft 11 in. (7 m)	✓	N/A	N/A
6.0 RGBA Double Row	1.3 in. (33 mm)	72 LEDs/ft (240 LEDs/m)	RGBA	80	502 / 1648	382 / 1254	22 ft 11 in. (7 m)	✓	N/A	N/A
12.0 RGBW Double Row	1.3 in. (33 mm)	72 LEDs/ft (240 LEDs/m)	RGBW	79	872 / 2862	664 / 2177	14 ft 9 in. (4.5 m)	✓	N/A	N/A
12.0 RGBA Double Row	1.3 in. (33 mm)	72 LEDs/ft (240 LEDs/m)	RGBA	75	872 / 2862	664 / 2177	14 ft 9 in. (4.5 m)	✓	N/A	N/A
4.4 5-in-1 RGBWW	2.46 in. (62.5 mm)	29 LED/ft (96 LED/m)	RGBWW	59	194.7 / 638.8	181.7 / 596.2	16 ft 4 in (5 m)	✓	N/A	N/A
8.8 5-in-1 RGBWW	2.46 in. (62.5 mm)	29 LED/ft (96 LED/m)	RGBWW	50	330.0 / 1082.7	308.0 / 1010.5	11 ft 6 in (3.5 m)	✓	N/A	N/A
RGBW Addressable	3.94 in. (100 mm)	18 LEDs/ft (60 LEDs/m)	Red	33.5	23.5 / 77	23.5 / 77	16 ft 5.64 in. (5.02 m)	N/A	N/A	✓ IP67
			Green	82	57.4 / 188.3	57.4 / 188.3				
			Blue	15.5	10.8 / 35.6	10.8 / 35.6				
			White	103	72.1 / 236.6	72.1 / 236.6				
			All	40	169.5 / 556.1	169.5 / 556.1				
5.2 Warm Dim	3.94 in. (100 mm)	36 LEDs/ft (120 LEDs/m)	Warm Dim	55	215 / 704	200.2 / 657	16 ft 4 in. (5 m)	✓	✓	✓

DIODE VISIBILITY CHART (Data below applies to installations with Milky lens only)

 <b>No Visible Diode = N</b> Note: Linea RibbonLyte has no visible diode					 <b>With Visible Diode = Y</b>									
Static White & Static Color RibbonLyte			Static White		Color Changing RibbonLyte									
0.75/1.5/2.2	3.0/4.4	5.0/6.0	3.0/6.0 Double Row	12.0 Double Row	4.4 RGBW Series 2	5.5 RGBW Series 2	8.8 RGBW Series 2	3.0/6.0/12.0 RGBW/A Double Row	4.4/8.8 5-in-1 RGBWW	Warm Dim	Variable White Series 2	3.0/6.0 Variable White Double Row	12.0 Variable White Double Row	RGBW Addressable
IP20 IP65 IP68	IP20 IP65 IP68	IP20 IP65 IP68	IP20	IP20	IP20	IP65 IP68	IP20	IP20	IP20	IP20 IP65 IP68	IP20 IP65 IP68	IP20	IP20	IP67
Y	N	N	Y	N	N	N	N	N	Y	N	N	Y	N	N

AVAILABLE DRIVERS / CONTROLLERS AND DIMMING OPTIONS / WIRE GAUGE CHART

NON-DIMMING ELECTRONIC DRIVERS

ELV & MLV DRIVERS



**30W, 60W, 96W**  
Non-Dimming Electronic  
Class 2 Drivers

Part No.:  
• DRVW2430 (30 Watt)  
• DRVW2460 (60 Watt)  
• DRVW2496 (96 Watt)  
Output Voltage: 24 V  
Voltage Range: 120-277 VAC  
IP Rating: Dry or Damp  
UL Listed



**240W, 320W**  
Non-Dimming  
Electronic Drivers

Part No.:  
• DRVW24240 (240 Watt)  
• DRVW24320 (320 Watt)  
Output Voltage: 24 V  
Voltage Range: 90-305 VAC  
IP Rating: Dry or Damp  
UL Recognized



**60W, 96W, 150W, 300W, 600w\_test**  
ELV/MLV Dimmable Drivers

Part No.:  
• DRVW2460ELVMLV (60 Watt)  
• DRVW2496ELVMLV (96 Watt)  
• DRVW24150ELVMLV (150 Watt)  
• DRVW24300ELVMLV (300 Watt)  
Line Voltage Dimmable Drivers  
Output Voltage: 24 V  
Voltage Range: 100-277 VAC  
IP Rating: IP67  
UL, CE, and CSA Listed

0-10V DRIVERS



**0-10V Dimmable Waterproof Drivers**

**96W** Part No.: DRVW249610P  
**288W** Part No.: DRVW2428810P  
Output Voltage: 24 V (+/- 0.5V)  
Voltage Range: 100-277 VAC  
Environmental Rating: UL Wet Location  
UL Listed



**0-10V Dimmable 90W VW/WD Driver**

Part No.: DRVRFWDVW2490120

DMX CONTROLLER AND PART NUMBER - FOR COLOR CHANGING VERSIONS



**GLASS TOUCH**  
**WALL CONTROLLERS**  
Part Number: AWCRGBWBK  
AWCVWBK



**1 ZONE WALL CONTROLLER**  
Part Number: DMXCTRLG



**5 ZONE WALL CONTROLLER**  
Part Number: DMXCTRL



**10 ZONE WALL CONTROLLER**  
Part Number: DMXCTRLD

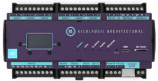

**2 UNIVERSE DMX CONTROLLER**  
Part Number: DMXCTRLDR2U



**4 CHANNEL WATERPROOF**  
**DMX INTERFACE**  
Part Number: DMXINFWLCD4



**5 CHANNEL**  
**DMX INTERFACE**  
Part Number: DMXINFOLED5



**DMX OPTO SPLITTER**  
Part Number: DMXOS8

**6 UNIVERSE DMX CONTROLLER**  
Part Number: DMXCTRLDR6U

DRIVER AND RIBBONLYTE AT FULL LOAD

Wattages	30		60		96		150		200		240		300		320		
	Wire Gauge	Feet	Meters	Feet	Meters	Feet	Meters	Feet	Meters	Feet	Meters	Feet	Meters	Feet	Meters	Feet	Meters
24 AWG / 0.25 mm <sup>2</sup>	14	4.27	9	2.74	5.5	1.68	3.75	1.14	2.75	0.84	2.25	0.69	1.75	0.53	1.75	0.53	0.53
22 AWG / 0.34 mm <sup>2</sup>	22	6.71	14	4.27	9	2.74	5.75	1.75	4.5	1.37	3.5	1.07	2.75	0.84	2.75	0.84	0.84
20 AWG / 0.5 mm <sup>2</sup>	35	10.67	23	7.01	14	4.27	9	2.74	7	2.13	5.75	1.75	4.5	1.37	4.25	1.30	1.30
18 AWG / 0.75 mm <sup>2</sup>	56	17.07	37	11.28	23	7.01	15	4.57	11	3.35	9	2.74	7.5	2.29	7	2.13	2.13
16 AWG / 1.5 mm <sup>2</sup>	90	27.44	60	18.29	37	11.28	24	7.32	18	5.49	15	4.57	12	3.66	11	3.35	3.35
14 AWG / 2.5 mm <sup>2</sup>	142	43.29	95	28.96	59	17.99	38	11.59	28	8.54	23	7.01	19	5.79	17	5.18	5.18
12 AWG / 4 mm <sup>2</sup>	226	68.90	151	46.04	94	28.66	60	18.29	45	13.72	37	11.28	30	9.15	28	8.54	8.54
10 AWG / 6 mm <sup>2</sup>	360	109.76	240	73.17	150	45.73	96	29.27	72	21.95	60	18.29	48	14.63	45	13.72	13.72
8 AWG / 10 mm <sup>2</sup>	574	175.00	381	116.16	239	72.87	153	46.65	115	35.06	95	28.96	76	23.17	71	21.65	21.65



WIRING DIAGRAMS

0-10V

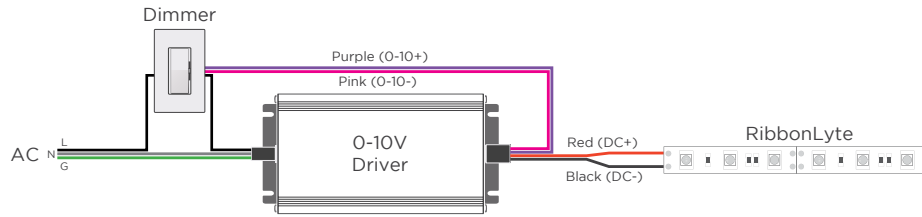

MLV / ELV

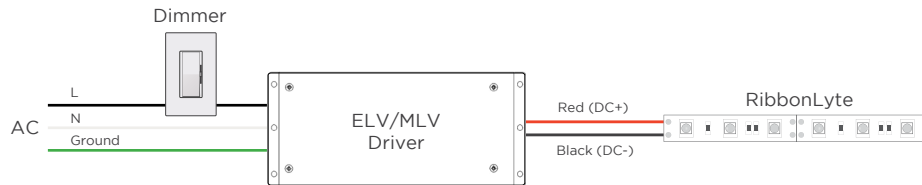

DMX

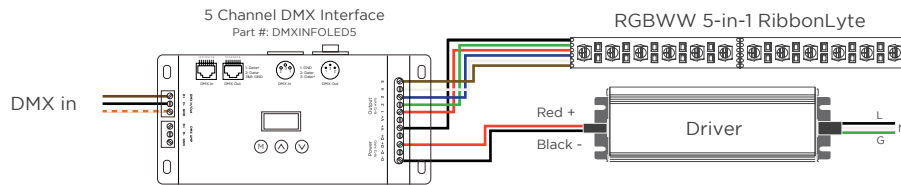

WARM DIM

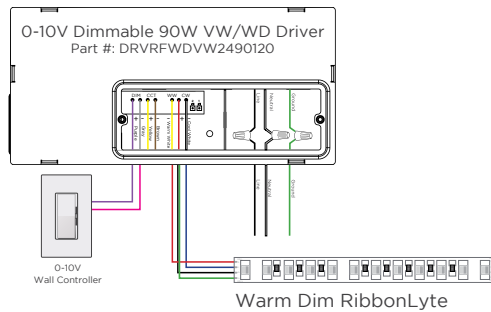

2-CHANNEL VARIABLE WHITE DIMMING

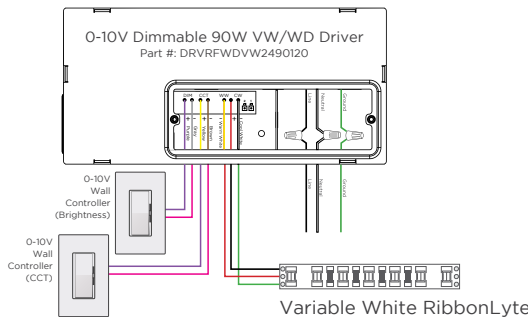

DMX WIRING DIAGRAM - COMPATIBLE WITH ALL MODELS OF VARIABLE WHITE RIBBONLYTE

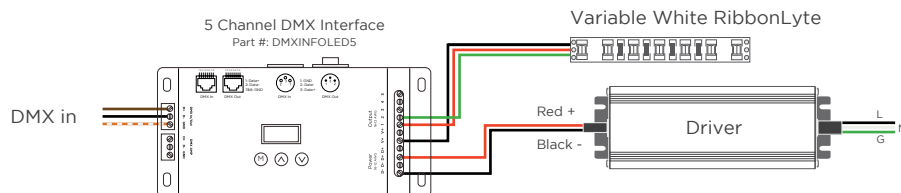

WIRE COLORS PER RIBBONLYTE COLOR

**STATIC WHITE + STATIC COLOR**  
Red Wire (+) Positive  
Black Wire (-) Negative

**RGBW + RGBA**  
Black Wire (+) Positive  
Green Wire (-) goes to Green Channel  
Red Wire (-) goes to Red Channel  
Blue Wire (-) goes to Blue Channel  
White Wire (-) goes to White Channel

**RGBWW**  
Black (+) Positive  
Green Wire (-) goes to Green Channel  
Red Wire (-) goes to Red Channel  
Blue Wire (-) goes to Blue Channel  
White Wire (-) goes to White Channel 1  
Brown Wire (-) goes to White Channel 2

**WARM DIM**  
Red Wire (-) goes to Warm White Channel  
Blue Wire (-) goes to Cool White Channel  
Black Wire (+) goes to Warm White Channel  
Green Wire (+) goes to Cool White Channel



**VARIABLE WHITE**  
Black Wire (+) Positive  
Red Wire (-) goes to Warm White Channel  
Green Wire (-) goes to Cool White Channel

WIRING DIAGRAMS WITH RGBW ADDRESSABLE RIBBONLYTE

One DMX Universe consists of 128 addresses and 512 channels (42 ft, 8 in. of RibbonLyte).

Any single run of RibbonLyte that is less than 16 ft, 4 in. can be wired directly to the controller.

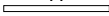
For additional runs, Opto Splitter must be used. Each individual run will need its own Opto Splitter output.

WIRE INDEX	
+	
PI	
A+	
B-	
GND	