

Product Description:

- Constant voltage LED power supply
- Universal input voltage range
- Constant output voltage
- Connection cable with stripped cable end (length approx. 350 mm)
- Polarity identifiers, secondary + red / - black
- Color white
- Nominal lifetime >70,000 h (at 230Vac, full load, Tc: 80°C)
- 7-year guarantee (for Tc: 80°C)
- Suitable for emergency installation according EN 50172



Properties:

- Small design
- Low power loss
- Short-circuit shutdown feature w/automatic restart
- OVP, OCP, OTP and surge protection
- SELV
- Type of protection: IP68
- Metal casing, encapsulated, painting white



ORDERING GUIDE

Type	PS24-30W-GN
Article Number	28000516A
Packaging Carton	30 pc(s).
Package Dimensions (L x W x L)	7.87 x 2.95 x 1.97 in. (200 x 75 x 50 mm)
Weight per pc.	1.1 lb (0.5 kg)
Carton Dimensions (L x W x L)	16.34 x 15.75 x 6.69 in. (415 x 400 x 170 mm)
Carton Weight	37.92 lb (17.2 kg)

SPECIFIC TECHNICAL DATA

Type	PS24-30W-GN
Max. Casing Temp T _c	194° F (90° C)
Output Voltage	24.7 V
Max. Input Power	50 W
Output Current Range	0-1.25 A
Max. Output Voltage	24.94 V

STANDARD COMPLIANCE

Safety	Safety Standards
Certifications	UL879, CLASS 2, CE, RoHS, FCC, MM

TECHNICAL DATA

Rated Supply Voltage	100-277 VAC
Input Voltage, AC	90-305 VAC
Input Voltage, DC	200-240 VDC
Max input current	0.5 A @ 100 VAC
Mains Frequency	47 - 63 Hz
Efficiency (at 230 V, 50 Hz, full load)	85%
λ (at 230 V, 50 Hz, full load)	> 0.90
THD	< 20%
Output Voltage Tolerance	< 240 mV
Output Power (T _a ≤ 60° C)	30 W
Output Power Range	0 - 30 W
No Load Power	> 0.5 W
Inrush Current	50 A
Turn On Time (Output)	≤ 0.5 s
Hold on Time at Power Failure (Output)	10 ms
Ambient Temperature T _a	-40° — +140° F (-40 ~ +60° C)
Storage Temperature T _s	-40° — +176° F (-40 ~ +80° C)
Dimensions (L x W x H)	7.36 x 1.61 x 1.14 in. (187 x 41 x 29 mm)

DIMENSIONS

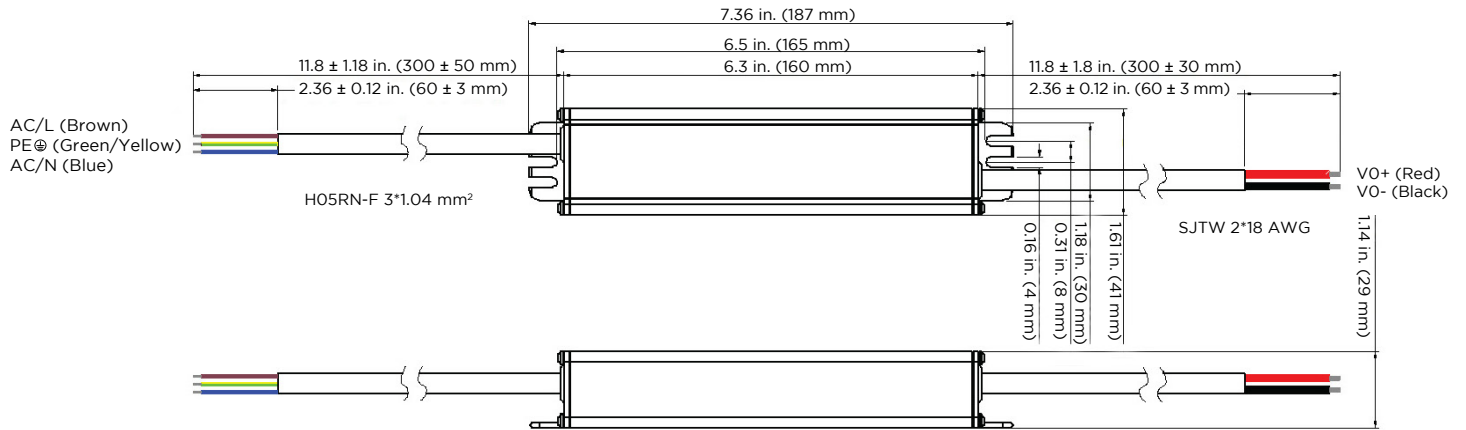

NOTE: To prevent exposure to the maximum allowable temperatures for these drivers, the suggested installation spacing between drivers is at least 4 in. (101.6 mm) side-to-side when the distance to the sidewall and top of the enclosure is 2 in. (50.8 mm). When the distance to the sidewall and top of the enclosure is 6 in. (152.4 mm), maintain at least 2 in. (50.8 mm) side-to-side spacing between drivers. Drivers should be placed at a minimum of 1 in. (25.4 mm) apart when arranging them end-to-end regardless of the enclosure size.

CONNECTION

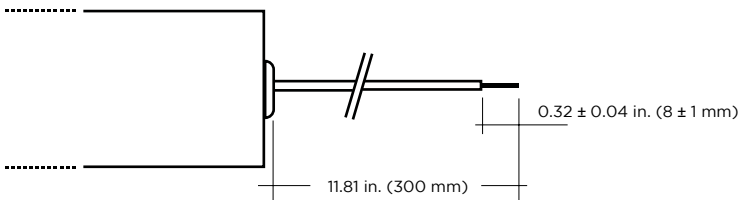

Primary Cable			Secondary Cable	
L	N	PG	+	-
brown	blue	green/yellow	red	black

WIRING DIAGRAM

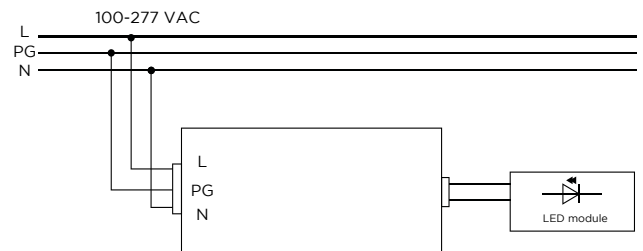

DRIVER REMOTE DISTANCES

Wattages	PS24-30W-GN	
	Feet	Meters
24 AWG / 0.20 mm ²	19.88	6.061
22 AWG / 0.33 mm ²	33.64	10.256
20 AWG / 0.52 mm ²	51.45	15.686
18 AWG / 0.82 mm ²	83.30	25.397
16 AWG / 1.31 mm ²	134.56	41.026
14 AWG / 2.08 mm ²	213.33	65.041
12 AWG / 3.31 mm ²	336.41	102.564
10 AWG / 5.26 mm ²	530.10	161.616
8 AWG / 8.37 mm ²	833.02	253.968

NOTE: Calculations include a standard 10% buffer

PERFORMANCE CURVE

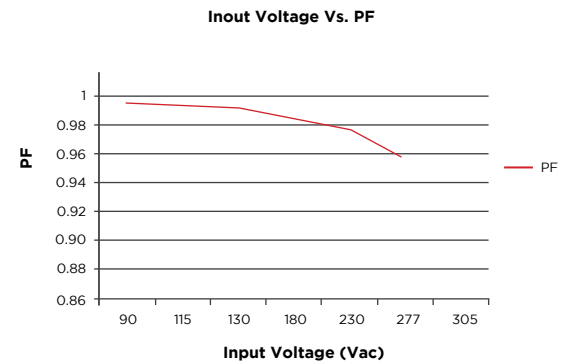
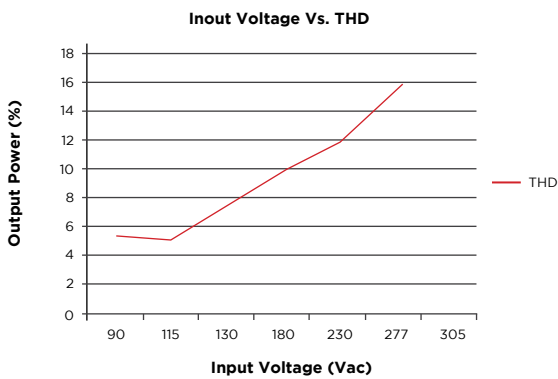
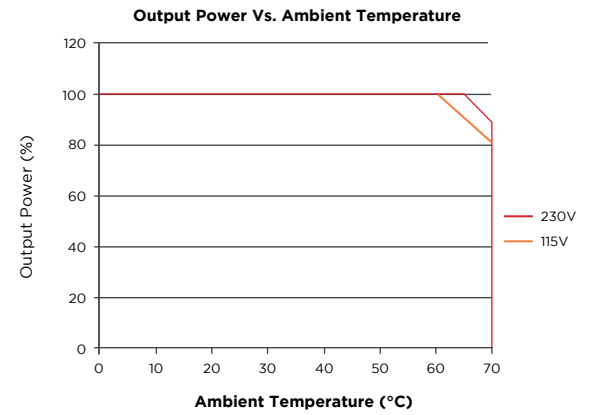
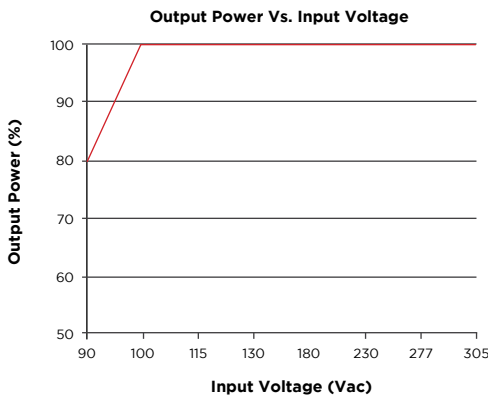
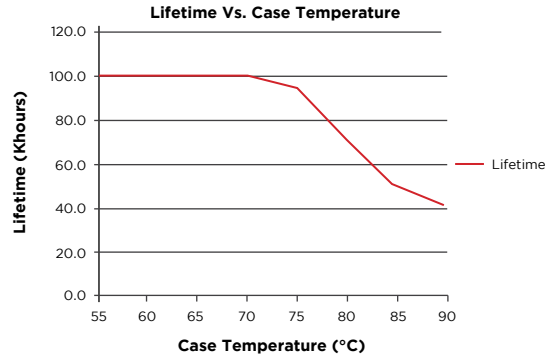
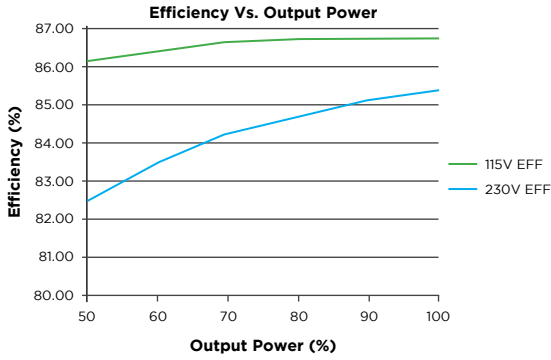

1. The maximum case temperature Tc shall not exceed 194°F (90°C) when used in end product.
2. These products are intended to be connected to a max. 20 A branch circuit.
3. These products are intended for use in dry and damp locations.
4. **Required spacing between power supply according to UL48.**