

#### Product Description:

- Constant voltage LED power supply
- Universal input voltage range
- Constant output voltage
- Connection cable with stripped cable end (length approx. 350 mm)
- Polarity identifiers, secondary + red / - black
- Color white
- Nominal lifetime >70,000 h (at 230Vac, full load, Tc: 80°C)
- 7-year guarantee (for Tc: 80°C)
- Suitable for emergency installation according EN 50172

#### Properties:

- Small design
- Low power loss
- Short-circuit shutdown feature w/automatic restart
- OVP, OCP, OTP and surge protection
- SELV
- Type of protection: IP68
- Metal casing, encapsulated, painting white



#### ORDERING GUIDE

Type	PS24-30W-GN
Article Number	28000516A
Packaging Carton	30 pc(s).
Package Dimensions (L x W x L)	7.87 x 2.95 x 1.97 in. (200 x 75 x 50 mm)
Weight per pc.	1.1 lb (0.5 kg)
Carton Dimensions (L x W x L)	16.34 x 15.75 x 6.69 in. (415 x 400 x 170 mm)
Carton Weight	37.92 lb (17.2 kg)

#### SPECIFIC TECHNICAL DATA

Type	PS24-30W-GN
Max. Casing Temp T <sub>c</sub>	194° F (90° C)
Output Voltage	24.7 V
Max. Input Power	50 W
Output Current Range	0-1.25 A
Max. Output Voltage	24.94 V

#### STANDARD COMPLIANCE

Safety	Safety Standards
Certifications	UL879, CLASS 2, CE, RoHS, FCC, MM

#### TECHNICAL DATA

Rated Supply Voltage	100-277 VAC
Input Voltage, AC	90-305 VAC
Input Voltage, DC	200-240 VDC
Max input current	0.5 A @ 100 VAC
Mains Frequency	47 - 63 Hz
Efficiency (at 230 V, 50 Hz, full load)	85%
λ (at 230 V, 50 Hz, full load)	> 0.90
THD	< 20%
Output Voltage Tolerance	< 240 mV
Output Power (T <sub>a</sub> ≤ 60° C)	30 W
Output Power Range	0 - 30 W
No Load Power	> 0.5 W
Inrush Current	50 A
Turn On Time (Output)	≤ 0.5 s
Hold on Time at Power Failure (Output)	10 ms
Ambient Temperature T <sub>a</sub>	-40° — +140° F (-40 ~ +60° C)
Storage Temperature T <sub>s</sub>	-40° — +176° F (-40 ~ +80° C)
Dimensions (L x W x H)	7.36 x 1.61 x 1.14 in. (187 x 41 x 29 mm)

**DIMENSIONS**

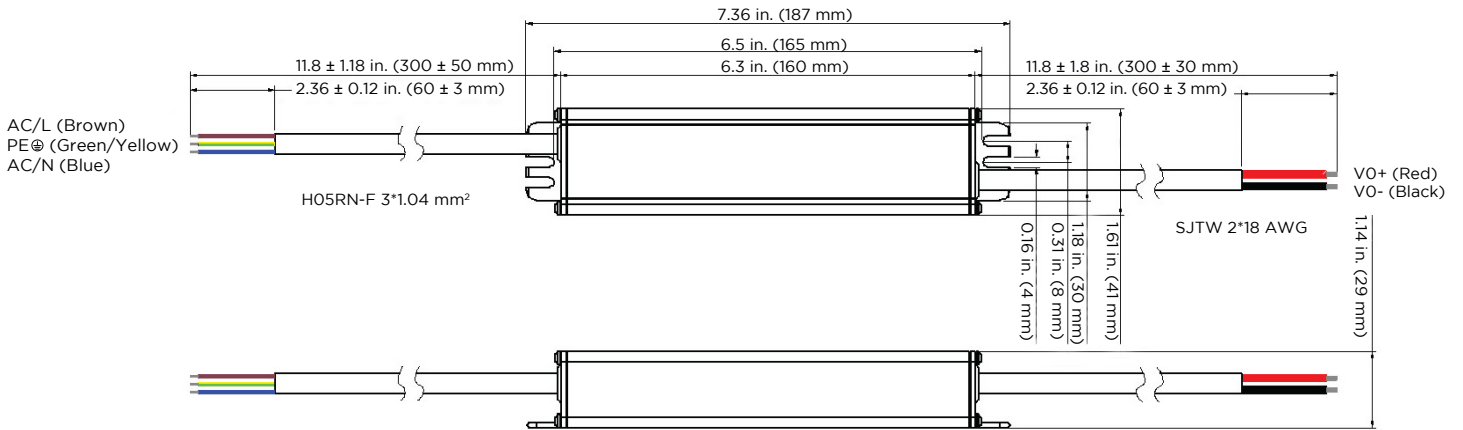

**NOTE:** To prevent exposure to the maximum allowable temperatures for these drivers, the suggested installation spacing between drivers is at least 4 in. (101.6 mm) side-to-side when the distance to the sidewall and top of the enclosure is 2 in. (50.8 mm). When the distance to the sidewall and top of the enclosure is 6 in. (152.4 mm), maintain at least 2 in. (50.8 mm) side-to-side spacing between drivers. Drivers should be placed at a minimum of 1 in. (25.4 mm) apart when arranging them end-to-end regardless of the enclosure size.

**CONNECTION**

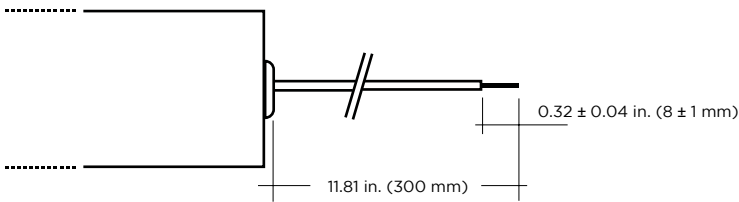

**WIRING DIAGRAM**

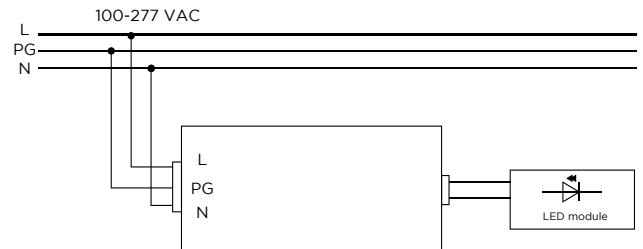

Primary Cable			Secondary Cable	
L	N	PG	+	-
brown	blue	green/yellow	red	black

DRIVER REMOTE DISTANCES		
Wattages	PS24-30W-GN	
Wire Gauge	Feet	Meters
24 AWG / 0.20 mm <sup>2</sup>	19.88	6.061
22 AWG / 0.33 mm <sup>2</sup>	33.64	10.256
20 AWG / 0.52 mm <sup>2</sup>	51.45	15.686
18 AWG / 0.82 mm <sup>2</sup>	83.30	25.397
16 AWG / 1.31 mm <sup>2</sup>	134.56	41.026
14 AWG / 2.08 mm <sup>2</sup>	213.33	65.041
12 AWG / 3.31 mm <sup>2</sup>	336.41	102.564
10 AWG / 5.26 mm <sup>2</sup>	530.10	161.616
8 AWG / 8.37 mm <sup>2</sup>	833.02	253.968

**NOTE:** Calculations include a standard 10% buffer

**PERFORMANCE CURVE**

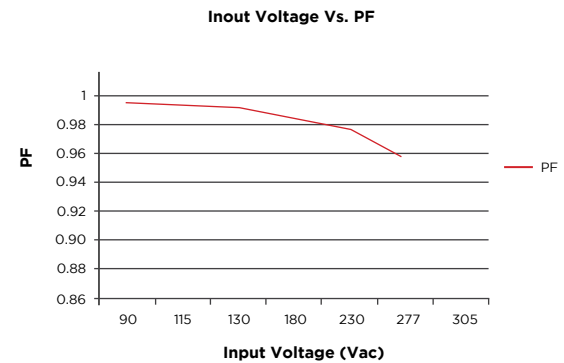
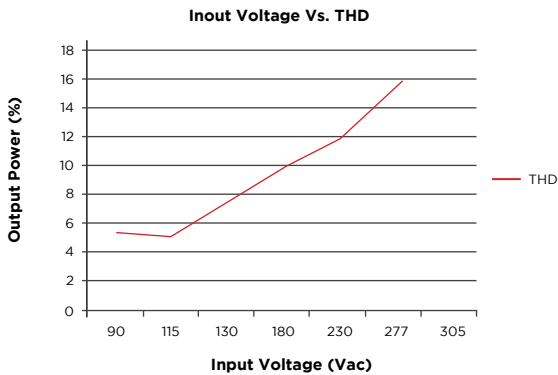
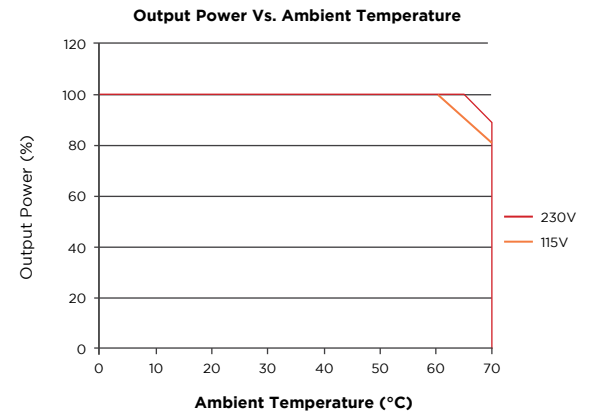
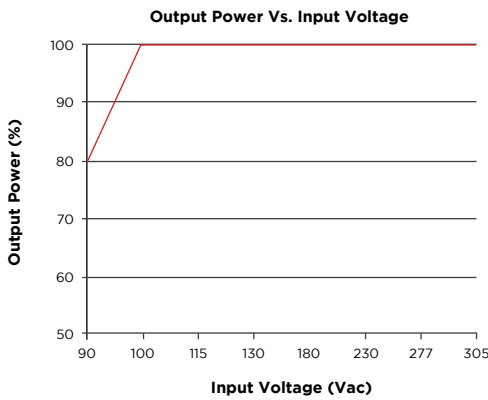
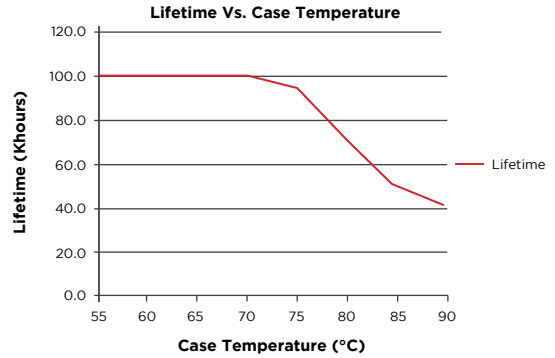
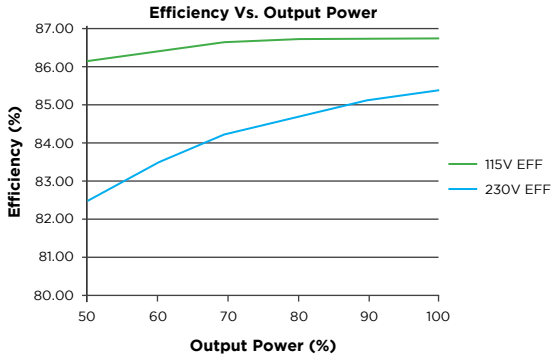

1. The maximum case temperature Tc shall not exceed 194°F (90°C) when used in end product.
2. These products are intended to be connected to a max. 20 A branch circuit.
3. These products are intended for use in dry and damp locations.
4. **Required spacing between power supply according to UL48.**

**GLOBAL HQ**

320 Murray Hill Pkwy  
East Rutherford, NJ 07073  
U.S.  
T: (+1) 212 629 6830  
E: Sales-US@GENLEDBrands.com

**EUROPEAN HQ**

Hogeweyselaan 119  
1382 JK Weesp  
Netherlands  
T: (+31) 346 235 000  
E: SalesEurope@GENLEDBrands.com

**MEINA HQ**

PO Box 371378, #823, Building 4EA  
Dubai Airport Free Zone  
Dubai, UAE  
T: (+971) 4 701 7901  
E: SalesMEINA@genledbrands.com

**ASIA-PACIFIC HQ**

Room 402, Building D  
Shenshi Tongchuang Science and Technology Park  
No. 16 Hongyin Road  
Xingqiang Community, Xinhui Street  
Guangming District, Shenzhen, China 518107  
Sales: (+86) 139 1836 3905  
Office: (+86) 755 8529 0710  
E: Sales-Pacific@GENLEDBrands.com