

SCROLL35S PENDANT FIXTURE

Fashion graceful custom side-illuminated fixtures with open curves or bold signature lighting pieces with the Scroll Pendant Series from Acolyte. Design fully closed shapes like simple circles and triangles or complex undulating ovals, squares and lines, all manufactured to your precise specification. If you can draw it, we can do it! The incredibly flexible Scroll Pendant Series also allows us to generate complementary custom luminaires in surface mounted fixtures.

- Create side-illuminated pendant or surface mounted fixtures
- Available in 2700K, 3000K, 3500K, 4000K, Variable White, RGBW
- Static White high output models at 555 lm/ft (1820 lm/m)
- Minimum bending radius: 11.81 in. (300 mm)
- Static White: 0-10V, ELV/MLV, and Dali dimming
- RGBW and Variable White: 0-10V VW dimming
- Compatible with DMX controls
- Standard silver finish
- Special order Black, White, Gold or custom RAL



HOUSING FINISHES

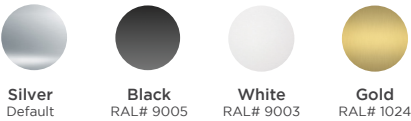

Note: Custom colors available upon request

LENS FINISH

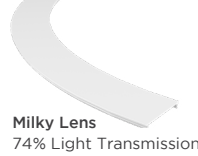

MOUNTING OPTIONS

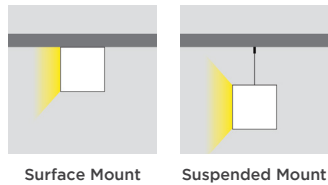

ILLUMINATION OPTIONS

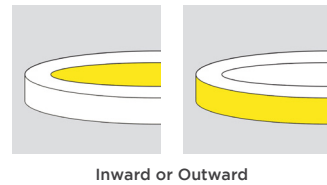

AVAILABLE COLOR TEMPERATURES & COLORS

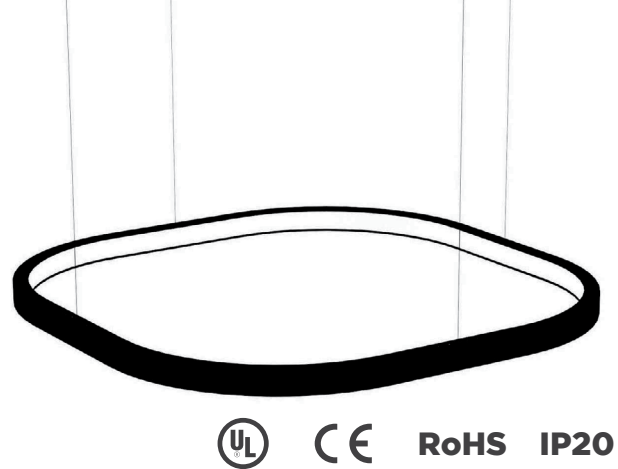
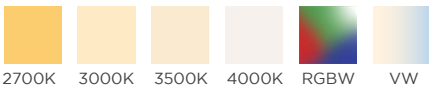

ORDERING GUIDE

Fixture Length	Illumination Direction	Output (VW and RGBW in Standard Output only)	Mounting Type*
SL35			
SL35 - Scroll35S Side Illuminated Fixture	I - Inward O - Outward	SO - Standard Direct Only HO - High Direct Only	P - Suspended Pendant S - Surface

Color Temperature and Colors	Surface Finish	Run
27 - 2700K 40 - 4000K	SV - Silver GD - Gold	S - Straight
30 - 3000K VW - Variable White	BK - Black C - Custom	C - Curved
35 - 3500K RGBW - RGBW	WH - White	

*The standard length of Suspended Mounting Kit cables is 6 ft 6.74 in. (2 m). Custom lengths are available up to 32 ft 9.7 in. (10 m).

QUOTING PROCESS	PRODUCTION PROCESS
Scroll Pendants allow for complex custom designs. To quote for Scroll Pendants, Acolyte requires a detailed floor plan with scale. This lets us calculate proper angles and section lengths. Quotes will take 2-3 business days.	After we receive a Purchase Order, our engineering team will provide a dimension drawing that shows the precise specifications of each pendant. Drawings take 2-3 business days. The client must review, approve and return a signed dimension drawing before production begins.

SPECIFICATIONS

Beam Angle	110°									
Lens Type	Milky Lens (PMMA)									
Length	Channel max lengths are 8 ft 2.4 in. (2.5 m) / Lens max lengths are 19 ft 8 in. (6 m)									
Dimming	Static White: 0-10V, (DALI coming soon) RGBW and Variable White: 0-10V VW Driver, DMX									
CCTs & Colors	2700K, 3000K, 3500K, 4000K		VW			RGBW				
Power	Standard Output 4.3 W/ft (14 W/m)	High Output 8.5 W/ft (28 W/m)	All On 4.3 W/ft (14 W/m)	Cool Only 2.1 W/ft (7 W/m)	Warm Only 2.1 W/ft (7 W/m)	All On 8.5 W/ft (28 W/m)	Red Only 2.1 W/ft (7 W/m)	Green Only 2.1 W/ft (7 W/m)	Blue Only 2.1 W/ft (7 W/m)	White Only 2.1 W/ft (7 W/m)
Voltage	Constant Current			24V Constant Voltage						
Lumens	300 lm/ft (984 lm/m)	555 lm/ft (1820 lm/m)	90 lm/ft (295 lm/m)	35 lm/ft (115 lm/m)	30 lm/ft (98 lm/m)	150 lm/ft (492 lm/m)	15 lm/ft (49 lm/m)	30 lm/ft (98 lm/m)	5 lm/ft (16 lm/m)	40 lm/ft (131 lm/m)
Lumens/Watt	71 lm/W	65 lm/W	21 lm/W	16 lm/W	13 lm/W	18 lm/W	7 lm/W	15 lm/W	3 lm/W	19 lm/W
CRI	90+									
Certifications	UL, CE, RoHS									

ACCESSORIES

<p>Coupler</p> <p>Part #: SLS35COUP</p> 	<p>Suspended Mounting Kit (included accessory)</p>  <p>NOTE: The standard length of Suspended Mounting Kit cables is 6 ft 6.74 in. (2 m). Custom lengths are available up to 32 ft 9.7 in. (10 m).</p>	<p>End Caps (included accessory)</p> 	<p>Power Feed Canopy Kit</p> <p>Part #: LLFEEDKITWHT (White) Part #: LLFEEDKITBLK (Black)</p> 
--	---	--	--

DIMENSIONS

SCROLL35S

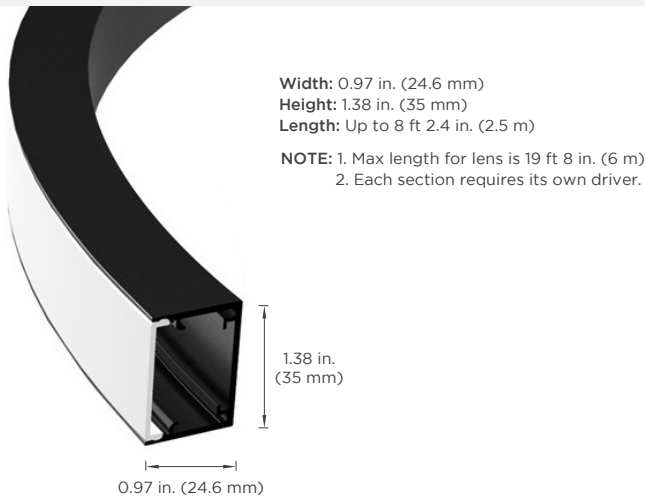

WARNING: DO NOT bend fixture past the listed minimum bending radius. Defects caused by over-bending will result in a voided warranty.

UNDERSTANDING THE MINIMUM BENDING RADIUS (MAXIMUM CURVATURE)

The bending radius of a curve is the radius of the circle that would exist if the curve were extended to form a circle.

For example, we have a fixture of length L:



Let's bend this fixture.
If we extend this curve to form a circle, we will see something like this:

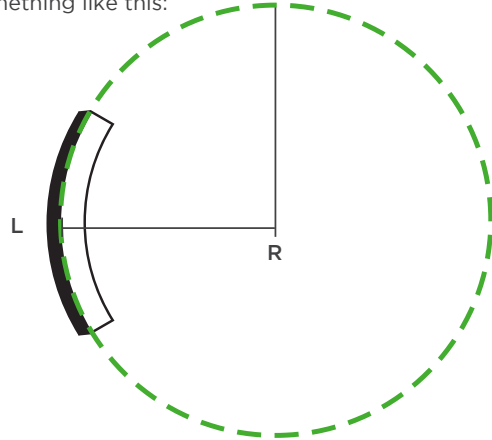

The diameter D of that circle would be our curve's bending radius.

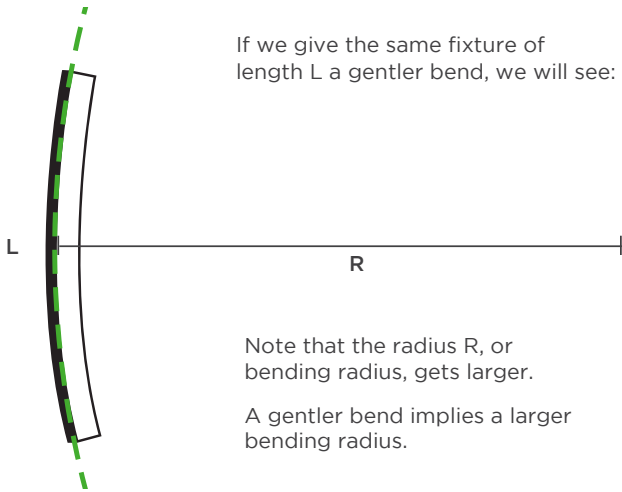

If we give the same fixture of length L a gentler bend, we will see:

Note that the radius R, or bending radius, gets larger.

A gentler bend implies a larger bending radius.

If we give the same fixture of length L a sharper bend, we will see:

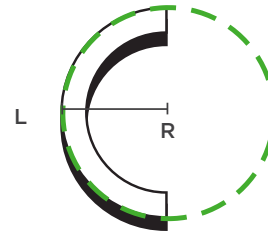

The radius R, or bending radius, gets smaller.
A sharper bend implies a smaller bending radius.

We define a fixture's minimum bending radius because of this relationship; some of our fixtures are limited by the sharpness of the specified bend. A fixture's minimum bending radius defines the sharpest curve it can make without jeopardizing the integrity of the LED performance.

Scroll35S Pendants have a minimum bending radius of 11.81 in. (300 mm)

Minimum Bending Radius = Maximum Curvature

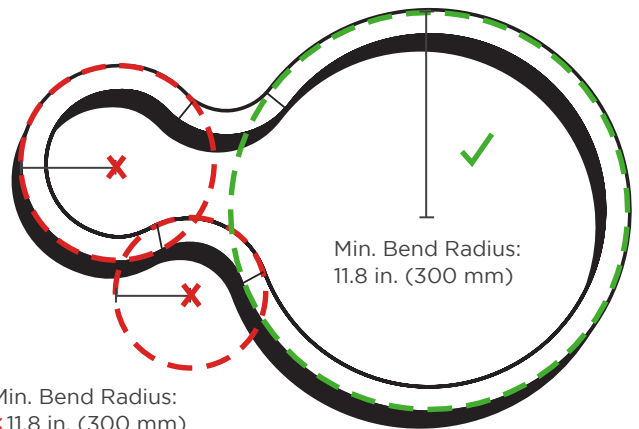

Min. Bend Radius:
11.8 in. (300 mm)

Min. Bend Radius:
< 11.8 in. (300 mm)

SUGGESTED SUSPENSION WIRE SEPARATED DISTANCES

SUGGESTED SUSPENSION WIRE SEPARATED DISTANCES

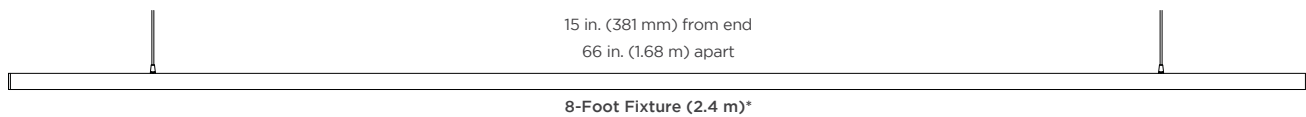
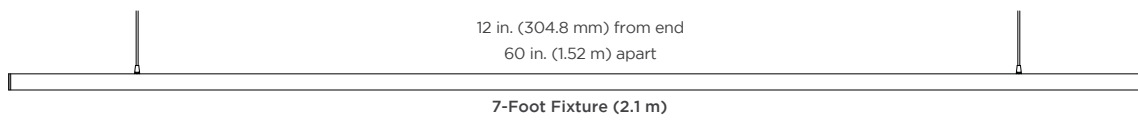
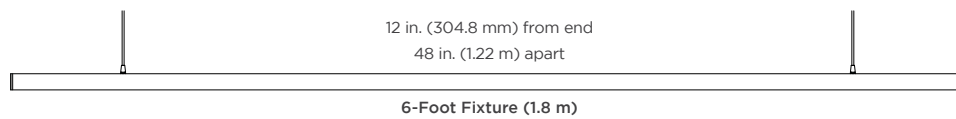
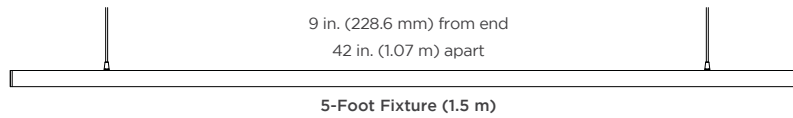
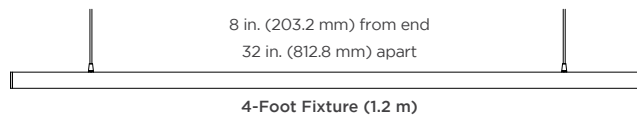
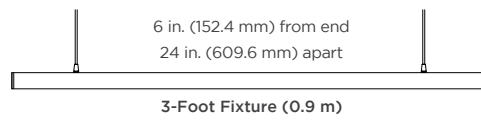
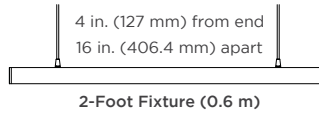

NOTE: Each section requires its own driver.

REV.20SEP2024