

### SCROLL35S PENDANT FIXTURE

Fashion graceful custom side-illuminated fixtures with open curves or bold signature lighting pieces with the Scroll Pendant Series from Acolyte. Design fully closed shapes like simple circles and triangles or complex undulating ovals, squares and lines, all manufactured to your precise specification. If you can draw it, we can do it! The incredibly flexible Scroll Pendant Series also allows us to generate complementary custom luminaires in surface mounted fixtures.

- Create side-illuminated pendant or surface mounted fixtures
- Available in 2700K, 3000K, 3500K, 4000K, Variable White, RGBW
- Static White high output models at 555 lm/ft (1820 lm/m)
- Minimum bending radius: 11.81 in. (300 mm)
- Static White: 0-10V, ELV/MLV, and Dali dimming
- RGBW and Variable White: 0-10V VW dimming
- Compatible with DMX controls
- Standard silver finish
- Special order Black, White or custom RAL



#### HOUSING FINISHES

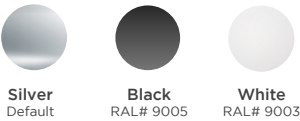

Note: Custom colors available upon request

#### LENS FINISH

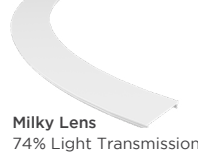

#### MOUNTING OPTIONS

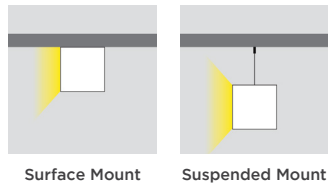

#### ILLUMINATION OPTIONS

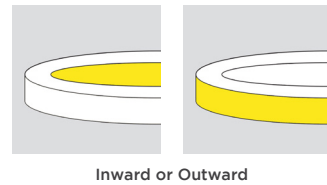

#### AVAILABLE COLOR TEMPERATURES & COLORS

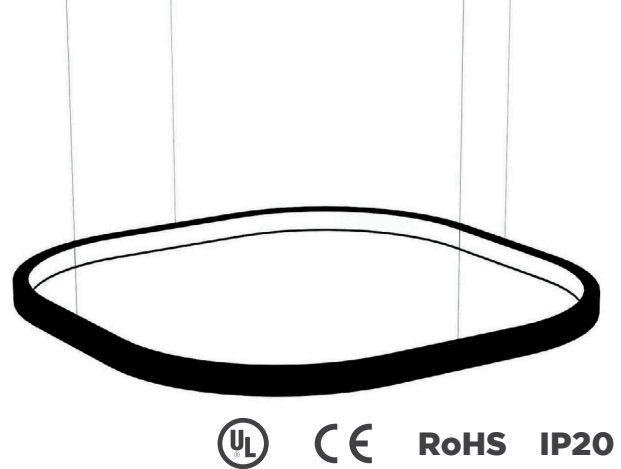
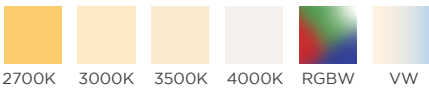

#### ORDERING GUIDE

Fixture Length	Illumination Direction	Output (VW and RGBW in Standard Output only)	Mounting Type*
SL35			
SL35 - Scroll35S Side Illuminated Fixture	I - Inward O - Outward	SO - Standard Direct Only HO - High Direct Only	P - Suspended Pendant S - Surface
Color Temperature and Colors	Surface Finish	Run	
27 - 2700K    40 - 4000K	SV - Silver	S - Straight	
30 - 3000K    VW - Variable White (2000K-6500K)	BK - Black	C - Curved	
35 - 3500K    RGBW - RGBW (3000K)	WH - White		
40 - 4000K	C - Custom		

\*The standard length of Suspended Mounting Kit cables is 6 ft 6.74 in. (2 m). Custom lengths are available up to 32 ft 9.7 in. (10 m).

QUOTING PROCESS	PRODUCTION PROCESS
Scroll Pendants allow for complex custom designs. To quote for Scroll Pendants, Acolyte requires a detailed floor plan with scale. This lets us calculate proper angles and section lengths. Quotes will take 2-3 business days.	After we receive a Purchase Order, our engineering team will provide a dimension drawing that shows the precise specifications of each pendant. Drawings take 2-3 business days. The client must review, approve and return a signed dimension drawing before production begins.

**SPECIFICATIONS**

Beam Angle	110°									
Lens Type	Milky Lens (PMMA)									
Length	Channel max lengths are 8 ft 2.4 in. (2.5 m) / Lens max lengths are 19 ft 8 in. (6 m)									
Dimming	Static White: 0-10V, (DALI coming soon) RGBW and Variable White: 0-10V VW Driver, DMX									
CCTs & Colors	2700K, 3000K, 3500K, 4000K		VW (2000K-6500K)			RGBW (3000K)				
Power	Standard Output	High Output	All On	Cool White (6500K)	Warm White (2000K)	All On	Red	Green	Blue	White (3000K)
	4.3 W/ft (14 W/m)	8.5 W/ft (28 W/m)	4.3 W/ft (14 W/m)	2.1 W/ft (7 W/m)	2.1 W/ft (7 W/m)	8.5 W/ft (28 W/m)	2.1 W/ft (7 W/m)	2.1 W/ft (7 W/m)	2.1 W/ft (7 W/m)	2.1 W/ft (7 W/m)
Voltage	Constant Current		24V Constant Voltage							
Lumens	300 lm/ft (984 lm/m)	555 lm/ft (1820 lm/m)	90 lm/ft (295 lm/m)	35 lm/ft (115 lm/m)	30 lm/ft (98 lm/m)	150 lm/ft (492 lm/m)	15 lm/ft (49 lm/m)	30 lm/ft (98 lm/m)	5 lm/ft (16 lm/m)	40 lm/ft (131 lm/m)
Lumens/Watt	71 lm/W	65 lm/W	21 lm/W	16 lm/W	13 lm/W	18 lm/W	7 lm/W	15 lm/W	3 lm/W	19 lm/W
CRI	90+									
Certifications	UL, CE, RoHS									

**ACCESSORIES**

<p><b>Coupler</b></p> <p>Part #: SLS35COUP</p> 	<p><b>Suspended Mounting Kit (included accessory)</b></p>  <p>NOTE: The standard length of Suspended Mounting Kit cables is 6 ft 6.74 in. (2 m). Custom lengths are available up to 32 ft 9.7 in. (10 m).</p>	<p><b>End Caps (included accessory)</b></p> 	<p><b>Power Feed Canopy Kit</b></p> <p>Part #: LLFEEDKITWHTV2 (White) Part #: LLFEEDKITBLKV2 (Black)</p> 
--	--	--	--

**DIMENSIONS**

**SCROLL35S**

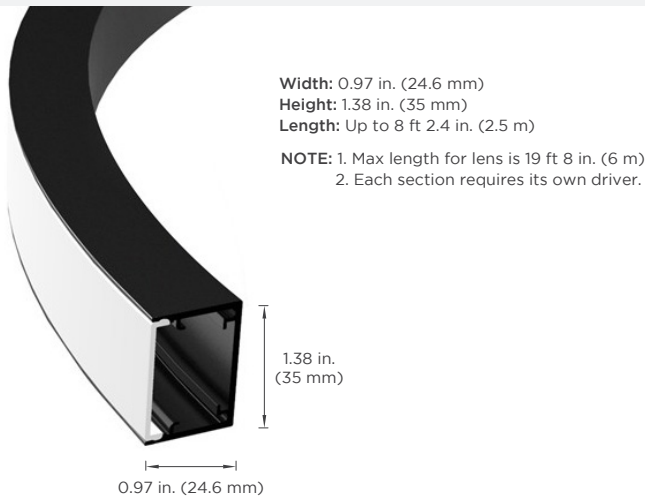

AVAILABLE DRIVERS/INTERFACE

	FOR STATIC WHITE MODELS				
	FOR AMERICAS ONLY			FOR OUTSIDE OF AMERICAS	
	0-10V 1% DIMMABLE 25W DRIVER*	0-10V 1% DIMMABLE 50W DRIVER*	0-10V 5% DIMMABLE 95W DRIVER*	CONSTANT CURRENT 50W DRIVER*	CONSTANT CURRENT 96W DRIVER*
Part Number	DRVCC25SS277010	DRVCC50SS277010	DRVCC95SS277010	DRVCC50DALIICH	DRVCC96DALIICH
Compatible Dimming	0-10 V	0-10 V	0-10 V	DALI2.0 / D4i	DALI2.0 / D4i
Output Voltage (VDC)	27 - 54 VDC	27 - 54 VDC	20 - 54 VDC	9 - 52 V	9 - 54 V
Output Wattage	25 W	50 W	95 W	50 W	96 W
Output Current	0.1 - 0.7 A	0.1 - 1.4 A	0.1 - 2.75 A	100 - 1400 mA (Default Current: 400 mA)	100 - 2800 mA (Default Current: 700 mA)
Input Voltage Range (VAC)	120 - 277 VAC	120 - 277 VAC	120 - 277 VAC	120 - 277 VAC	120 - 277 VAC
Input Current (A)	0.25 A (120 VAC) / 0.13 A (230 VAC) / 0.11 A (277 VAC)	0.48 A (120 VAC) / 0.25 A (230 VAC) / 0.21 A (277 VAC)	0.89 A (120 VAC) / 0.53 A (230 VAC) / 0.38 A (277 VAC)	0.6 A (120 VAC) / 0.28 A (277 VAC)	1 A (120 VAC) / 0.5 A (230 VAC) / 0.5 A (277 VAC)
Input Frequency	50 / 60 Hz	50 / 60 Hz	50 / 60 Hz	50 / 60 Hz	50 / 60 Hz
Max Input Power (W)	31 W	58 W	110 W	--	--
Efficiency @ Max Load	83 (120 VAC) / 85 (277 VAC)	86 (120 VAC) / 88 (277 VAC)	88 (120 VAC) / 89 (277 VAC)	≥87% (120 VAC) / ≥88% (277 VAC)	≥88% (120 VAC) / ≥90% (230 VAC) / ≥90% (277 VAC)
Max Input Current	0.25 A	0.48 A	0.89 A	0.60 A	1 A
THD @ Max Load	< 10% (120 VAC) < 15% (277 VAC)	< 10% (120 VAC) < 15% (277 VAC)	< 10% (120 VAC) < 15% (277 VAC)	≤10% (120 VAC)	<10% (120 VAC)
Power Factor @ Max Load	> 0.95	> 0.95	> 0.95	≥0.95 (120 VAC) / 0.90 (277 VAC)	≥0.95
Surge Protection (Combi-Wave, KV)	2.5	2.5	6	L-N 2500VAC L&N-PE 2500VAC	L-N 2500VAC L&N-PE 2500VAC
Expected Life Time	50,000 hours (< 65 °C)	50,000 hours (< 65 °C)	50,000 hours (< 65 °C)	50,000 hours (< 65 °C)	50,000 hours (< 65 °C)
Operating Temperature	-4 - 122 °F (-20 - 50 °C)	-4 - 122 °F (-20 - 50 °C)	-40 - 131 °F (-40 - 55 °C)	-4 - 122 °F (-20 - 50 °C)	-4 - 122 °F (-20 - 50 °C)
Safety Standards	UL8750, UL991, CSA250.13-14, C22.2 No. 0.8-12, CSA Class P, ETL Class P, UL2043 Plenum Rating	UL8750, UL991, CSA250.13-14, C22.2 No. 0.8-12, CSA Class P, ETL Class P, UL2043 Plenum Rating	UL8750, UL1310, CSA, UL Class P	CE - EN61347-1:2015+A1:2021, EN61347-2-13:2024, EN55015:2019	CE - EN61347-1:2015+A1:2021, EN61347-2-13:2024, EN55015:2019
Weight	0.44 lbs (0.2 kgs)	0.9 lbs (0.41 kgs)	1.5 lbs (0.68 kgs)	0.57 lbs (0.26 kgs)	0.77 lbs (0.35 kgs)
Dimensions (L x W x H)	4.21 x 2.38 x 0.98 in. (107 x 60 x 25 mm)	4.21 x 3.01 x 1.18 in. (107 x 76.4 x 30 mm)	8.37 x 1.7 x 1.14 in. (213 x 43 x 29 mm)	11.02 x 1.18 x 0.83 in. (280 x 30 x 21 mm)	14.17 x 1.18 x 0.83 in. (360 x 30 x 21 mm)

	FOR VARIABLE WHITE MODELS	FOR RGBW MODELS	
	0-10V DIMMABLE 90W VW/WD DRIVER*	5 CHANNEL DMX DECODER	24V NON-DIMMING UL LISTED ELECTRONIC DRIVERS*
Part Number	DRVRFWDVW2490120	DMXINF5	DRVW2496
Compatible Dimming	0-10 V	DIM/CT/RGB/RGBW/RGBWY	--
Output Voltage (VDC)	24 VDC	12-24 VDC	24 VDC
Output Wattage	90 W	--	96 W
Output Current	3.75 A	8 A/channel output (x 5 channels)	4.1 A
Input Voltage Range (VAC)	100 - 277 VAC	12-24 VDC	120 - 277 VAC
Input Frequency	50 / 60 Hz	--	50 / 60 Hz
Efficiency @ Max Load	89%	--	> 87% Max.
Operating Temperature	-86 - 104 °F (-20 - 50 °C)	-86 - 104 °F (-20 - 50 °C)	-13 - 104 °F (-25 - 40 °C)
Safety Standards	UL8750 + UL1310	CE, UL Recognized	UL, CLASS P
Dimensions (L x W x H)	8.4 x 4.1 x 1.5 in. (213 x 104 x 38 mm)	6.3 x 2.44 x 1.28 in. (160 x 62 x 32.6 mm)	12.1 x 2.36 x 1.4 in. (307 x 60 x 36 mm)

\* To prevent exposure to the maximum allowable temperatures for these drivers, the suggested installation spacing between drivers is at least 4 in. (101.6 mm) side-to-side when the distance to the sidewall and top of the enclosure is 2 in. (50.8 mm). When the distance to the sidewall and top of the enclosure is 6 in. (152.4 mm), maintain at least 2 in. (50.8 mm) side-to-side spacing between drivers. Drivers should be placed at a minimum of 1 in. (25.4 mm) apart when arranging them end-to-end regardless of the enclosure size.

DRIVER MATRIX

Length	Current per ft (mA)	Current per meter (mA)	Max Current Driver (mA)	Driver Part Number	Region
LO (Low Output) up to 7 ft or 2.1 m	90	295	700	DRVCC25SS277010	Americas only
LO (Low Output) up to 7 ft or 2.1 m	90	295	700	DRVCC50DALIICH	Outside of Americas
LO (Low Output) up to 8 ft or 2.4 m	90	295	1400	DRVCC50SS277010	Americas only
LO (Low Output) up to 8 ft or 2.4 m	90	295	1400	DRVCC50DALIICH	Outside of Americas
SO (Standard Output) up to 3 ft or 1 m	225	738	700	DRVCC25SS277010	Americas only
SO (Standard Output) up to 3 ft or 1 m	225	738	700	DRVCC50DALIICH	Outside of Americas
SO (Standard Output) up to 6 ft or 1.5 m	225	738	1400	DRVCC50SS277010	Americas only
SO (Standard Output) up to 6 ft or 1.5 m	225	738	1400	DRVCC50DALIICH	Outside of Americas
SO (Standard Output) up to 8 ft or 2.4 m	225	738	2750	DRVCC95SS277010	Americas only
SO (Standard Output) up to 8 ft or 2.4 m	225	738	2750	DRVCC96DALIICH	Outside of Americas
HO (High Output) up to 2 ft or 0.5 m	325	1066	700	DRVCC25SS277010	Americas only
HO (High Output) up to 2 ft or 0.5 m	325	1066	700	DRVCC50DALIICH	Outside of Americas
HO (High Output) up to 4 ft or 1 m	325	1066	1400	DRVCC50SS277010	Americas only
HO (High Output) up to 4 ft or 1 m	325	1066	1400	DRVCC50DALIICH	Outside of Americas
HO (High Output) up to 8 ft or 2.4 m	325	1066	2750	DRVCC95SS277010	Americas only
HO (High Output) up to 8 ft or 2.4 m	325	1066	2750	DRVCC96DALIICH	Outside of Americas

**UNDERSTANDING THE MINIMUM BENDING RADIUS (MAXIMUM CURVATURE)**

The bending radius of a curve is the radius of the circle that would exist if the curve were extended to form a circle.

For example, we have a fixture of length L:



Let's bend this fixture.  
If we extend this curve to form a circle, we will see something like this:

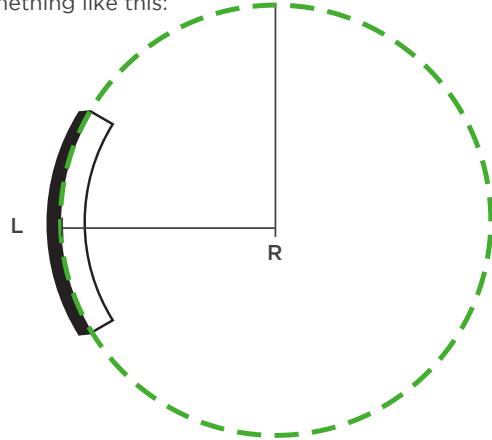

The radius R of that circle would be our curve's bending radius.

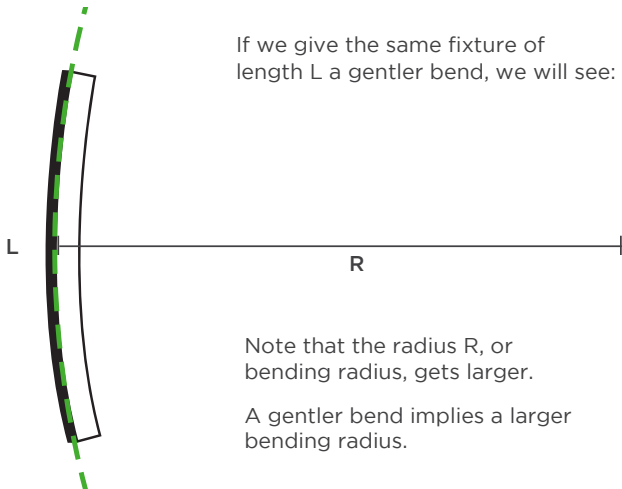

If we give the same fixture of length L a gentler bend, we will see:

Note that the radius R, or bending radius, gets larger.

A gentler bend implies a larger bending radius.

If we give the same fixture of length L a sharper bend, we will see:

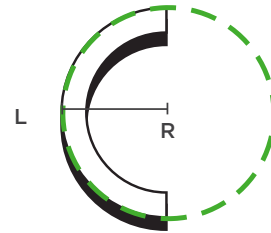

The radius R, or bending radius, gets smaller.  
A sharper bend implies a smaller bending radius.

We define a fixture's minimum bending radius because of this relationship; some of our fixtures are limited by the sharpness of the specified bend. A fixture's minimum bending radius defines the sharpest curve it can make without jeopardizing the integrity of the LED performance.

**Scroll35S Pendants have a minimum bending radius of 11.81 in. (300 mm)**

**Minimum Bending Radius = Maximum Curvature**

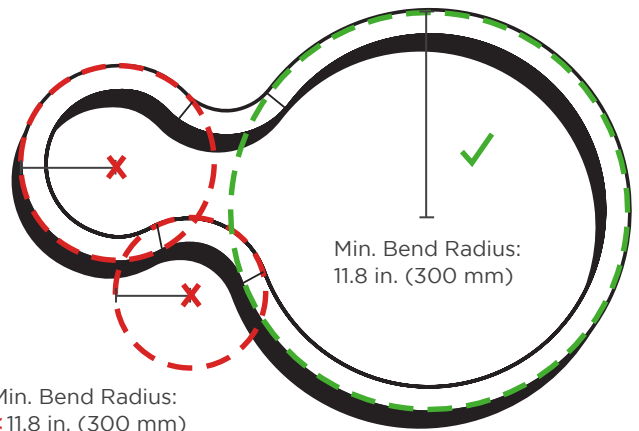

Min. Bend Radius:  
< 11.8 in. (300 mm)

SUGGESTED SUSPENSION WIRE SEPARATED DISTANCES

SUGGESTED SUSPENSION WIRE SEPARATED DISTANCES

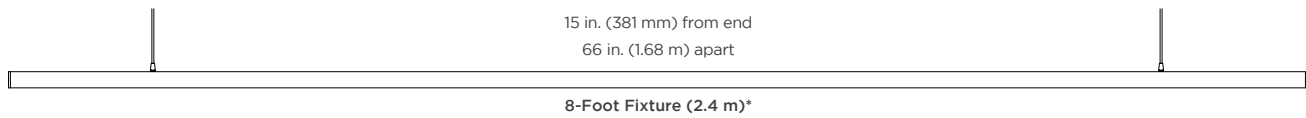
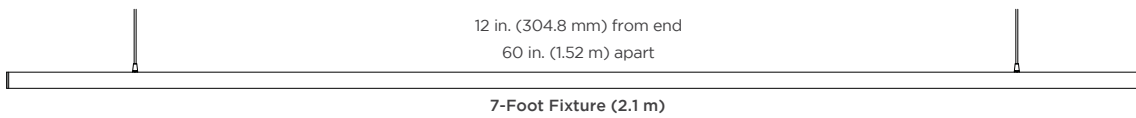
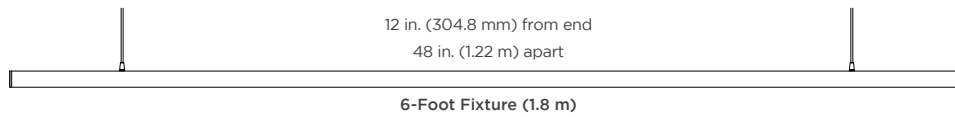
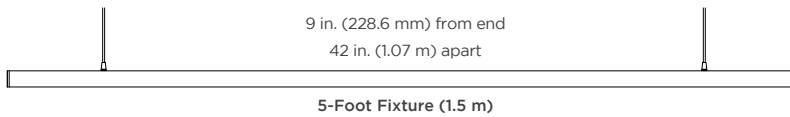
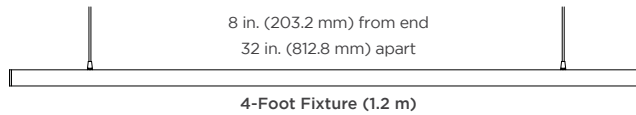
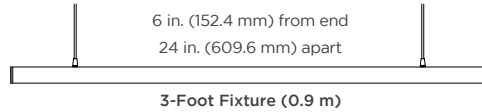
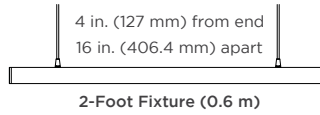

NOTE: Each section requires its own driver.

REV.22APR2026

**GLOBAL HQ**

320 Murray Hill Pkwy  
East Rutherford, NJ 07073  
U.S.  
T: (+1) 212 629 6830  
E: Sales-US@GENLEDBrands.com

**EUROPEAN HQ**

Hogeweyselaan 119  
1382 JK Weesp  
Netherlands  
T: (+31) 346 235 000  
E: SalesEurope@GENLEDBrands.com

**MEINA HQ**

PO Box 371378, #823, Building 4EA  
Dubai Airport Free Zone  
Dubai, UAE  
T: (+971) 4 701 7901  
E: SalesMEINA@genlebrands.com

**ASIA-PACIFIC HQ**

Room 402, Building D  
Shenshi Tongchuang Science and Technology Park  
No. 16 Hongyin Road  
Xingqiang Community, Xihu Street  
Guangming District, Shenzhen, China 518107  
T: (+86) 755 8529 0710  
E: Sales-Pacific@GENLEDBrands.com