

### SCROLL35S PENDANT FIXTURE

Fashion graceful custom side-illuminated fixtures with open curves or bold signature lighting pieces with the Scroll Pendant Series from Acolyte. Design fully closed shapes like simple circles and triangles or complex undulating ovals, squares and lines, all manufactured to your precise specification. If you can draw it, we can do it! The incredibly flexible Scroll Pendant Series also allows us to generate complementary custom luminaires in surface mounted fixtures.

- Create side-illuminated pendant or surface mounted fixtures
- Available in 2700K, 3000K, 3500K, 4000K, Variable White, RGBW
- Static White high output models at 555 lm/ft (1820 lm/m)
- Minimum bending radius: 11.81 in. (300 mm)
- Static White: 0-10V, DALI
- RGBW and Variable White: 0-10V VW Driver, DMX, DALI, Casambi
- Compatible with DMX controls
- Standard silver finish
- Special order Black, White or custom RAL



#### HOUSING FINISHES

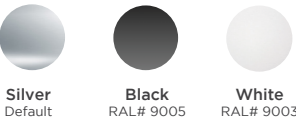

Note: Custom colors available upon request

#### LENS FINISH

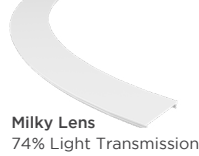

#### MOUNTING OPTIONS

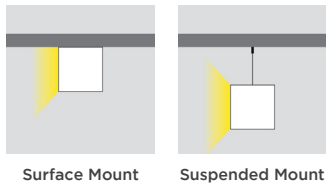

#### ILLUMINATION OPTIONS

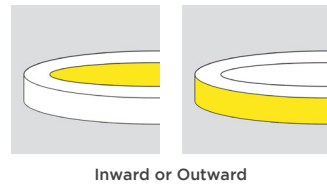

#### AVAILABLE COLOR TEMPERATURES & COLORS

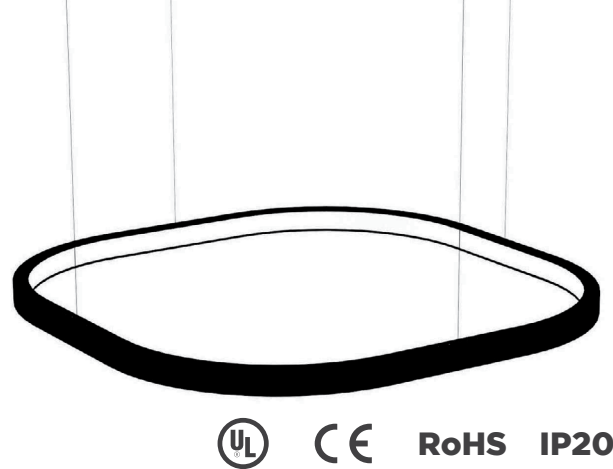
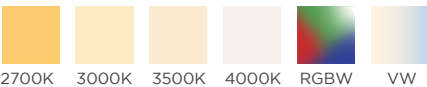

#### ORDERING GUIDE

Fixture Length	Illumination Direction	Output (VW and RGBW in Standard Output only)	Mounting Type*
SL35			
SL35 - Scroll35S Side Illuminated Fixture	I - Inward O - Outward	SO - Standard Direct Only HO - High Direct Only	P - Suspended Pendant S - Surface
Color Temperature and Colors	Surface Finish	Run	
27 - 2700K    40 - 4000K	SV - Silver	S - Straight	
30 - 3000K    VW - Variable White (2000K-6500K)	BK - Black	C - Curved	
35 - 3500K    RGBW - RGBW (3000K)	WH - White		
40 - 4000K	C - Custom		

\*The standard length of Suspended Mounting Kit cables is 6 ft 6.74 in. (2 m). Custom lengths are available up to 32 ft 9.7 in. (10 m).

QUOTING PROCESS	PRODUCTION PROCESS
Scroll Pendants allow for complex custom designs. To quote for Scroll Pendants, Acolyte requires a detailed floor plan with scale. This lets us calculate proper angles and section lengths. Quotes will take 2-3 business days.	After we receive a Purchase Order, our engineering team will provide a dimension drawing that shows the precise specifications of each pendant. Drawings take 2-3 business days. The client must review, approve and return a signed dimension drawing before production begins.

**SPECIFICATIONS**

Beam Angle	110°									
Lens Type	Milky Lens (PMMA)									
Length	Channel max lengths are 8 ft 2.4 in. (2.5 m) / Lens max lengths are 19 ft 8 in. (6 m)									
Dimming	Static White: 0-10V, DALI RGBW and Variable White: 0-10V VW Driver, DMX, DALI, Casambi									
CCTs & Colors	2700K, 3000K, 3500K, 4000K		VW (2000K-6500K)			RGBW (3000K)				
Power	Standard Output	High Output	All On	Cool White (6500K)	Warm White (2000K)	All On	Red	Green	Blue	White (3000K)
	4.3 W/ft (14 W/m)	8.5 W/ft (28 W/m)	4.3 W/ft (14 W/m)	2.1 W/ft (7 W/m)	2.1 W/ft (7 W/m)	8.5 W/ft (28 W/m)	2.1 W/ft (7 W/m)	2.1 W/ft (7 W/m)	2.1 W/ft (7 W/m)	2.1 W/ft (7 W/m)
Voltage	Constant Current			24V Constant Voltage						
Lumens	300 lm/ft (984 lm/m)	555 lm/ft (1820 lm/m)	90 lm/ft (295 lm/m)	35 lm/ft (115 lm/m)	30 lm/ft (98 lm/m)	150 lm/ft (492 lm/m)	15 lm/ft (49 lm/m)	30 lm/ft (98 lm/m)	5 lm/ft (16 lm/m)	40 lm/ft (131 lm/m)
Lumens/Watt	71 lm/W	65 lm/W	21 lm/W	16 lm/W	13 lm/W	18 lm/W	7 lm/W	15 lm/W	3 lm/W	19 lm/W
CRI	90+									
Certifications	UL, CE, RoHS									

**ACCESSORIES**

<p><b>Coupler</b></p> <p>Part #: SLS35COUP</p> 	<p><b>Suspended Mounting Kit (included accessory)</b></p>  <p>NOTE: The standard length of Suspended Mounting Kit cables is 6 ft 6.74 in. (2 m). Custom lengths are available up to 32 ft 9.7 in. (10 m).</p>	<p><b>End Caps (included accessory)</b></p> 	<p><b>Power Feed Canopy Kit</b></p> <p>Part #: LLFEEDKITWHTV2 (White) Part #: LLFEEDKITBLKV2 (Black)</p> 
--	--	--	--

**DIMENSIONS**

**SCROLL35S**

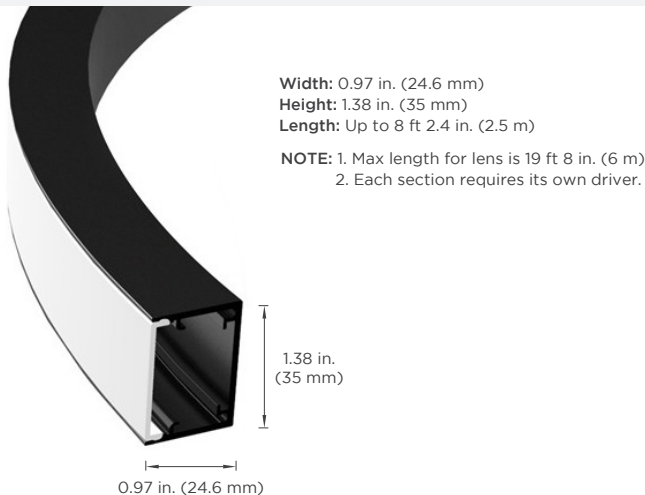

**WARNING:** DO NOT bend fixture past the listed minimum bending radius. Defects caused by over-bending will result in a voided warranty.

Acolyte does not warrant or represent that the information is free from errors or omission. The information may change without notice and Acolyte is not in any way liable for the accuracy of any information printed and stored or in any way interpreted or used.

AVAILABLE DRIVERS/INTERFACE

<p><b>0-10V Constant Current</b> For Static White models (Americas only)</p>  <p><b>0-10V 1% Dimmable 25W &amp; 50W Drivers</b> Part No.: DRVCC25SS277010 (25 W) DRVCC50SS277010 (50 W) 27-54 VDC 120-277 VAC UL8750, UL991, CSA250.13-14, C22.2 No. 0.8-12, CSA Class P, ETL Class P, UL2043 Plenum Rating</p> <p><b>0-10V 5% Dimmable 95W Drivers</b> Part No.: DRVCC95SS277010 20-54 VDC 120-277 VAC UL8750, UL1310, CSA, UL Class P</p>	<p><b>Constant Current DALI</b> For Static White models (outside of Americas)</p>  <p><b>50W &amp; 96W Constant Current DALI Driver</b> Part No.: DRVCC50DALI1CH (50 W) DRVCC96DALI1CH (96 W) 9-52 VDC (50 W) 9-54 VDC (96 W) 120-277 VAC CE - EN61347-1:2015+A1:2021, EN61347-2-13:2024 , EN55015:2019</p>	<p><b>CASAMBI Compatible</b> For Variable White, Warm Dim &amp; RGB models (all regions)</p>  <p><b>100W &amp; 200W Casambi Compatible 4 Channel Drivers</b> Part No.: • DRVW24100CAS4CH (100 W) • DRVW24200CAS4CH (200 W) 24 VDC 100-277 VAC UL Listed, CE, RoHS, Bluetooth, CASAMBI</p>		
<p><b>0-10V VW/WD</b> For Variable White &amp; Warm Dim models (Americas only)</p>  <p><b>0-10V Dimmable 90W VW/WD Driver</b> Part No.: DRVRFWDVW2490120 24 VDC 100-277 VAC UL 8750 + UL 1310</p>	<p><b>DALI-2 (2 channel)</b> For Variable White &amp; Warm Dim models (outside of Americas)</p>  <p><b>150W DALI-2 Dimmable 2 Channel Driver</b> Part No.: DRV24150DALI2CH 24 VDC 120-277 VAC CE, CB, ENEC (25), DALI2.0</p>	<p><b>0-10V/ELV/MLV 3-in-1</b> For RGBW models (Americas only)</p>  <p><b>60W, 96W, 288W 0-10V/ELV/MLV 3-in-1 Dimmable Drivers</b> Part No.: DRVW2460TRI010 (60 W) DRVW2496TRI010 (96 W) DRVW24288TRI010 (288 W) 24 VDC 120-277 VAC UL8750, UL1310, IEC 61000-4-2-3-4-5-6-8-11</p>	<p><b>DALI-2 (4 channel)</b> For RGBW models (outside of Americas)</p>  <p><b>150W DALI-2 Dimmable 4 Channel Drivers</b> Part No.: DRV24150DALI4CH 24 VDC 120-277 VAC CE, CB, ENEC (25), DALI2.0</p>	<p><b>Interface</b> For RGBW models (all regions)</p>  <p><b>5 Channel DMX Decoder</b> Part No.: DMXINF5 12-24 VDC CE, UL Recognized</p>

**NOTE:**  
To prevent exposure to the maximum allowable temperatures for these drivers, the suggested installation spacing between drivers is at least 4 in. (101.6 mm) side-to-side when the distance to the sidewall and top of the enclosure is 2 in. (50.8 mm). When the distance to the sidewall and top of the enclosure is 6 in. (152.4 mm), maintain at least 2 in. (50.8 mm) side-to-side spacing between drivers. Drivers should be placed at a minimum of 1 in. (25.4 mm) apart when arranging them end-to-end regardless of the enclosure size.

Please [download driver and interface specification sheets on Scroll35S product page for more details.](#)

DRIVER MATRIX (for Static White models only)

Length	Current per ft (mA)	Current per meter (mA)	Max Current Driver (mA)	Driver Part Number	Region
LO (Low Output) up to 7 ft or 2.1 m	90	295	700	DRVCC25SS277010	Americas only
LO (Low Output) up to 7 ft or 2.1 m	90	295	1400	DRVCC50DALI1CH	Outside of Americas
LO (Low Output) up to 8 ft or 2.4 m	90	295	1400	DRVCC50SS277010	Americas only
LO (Low Output) up to 8 ft or 2.4 m	90	295	1400	DRVCC50DALI1CH	Outside of Americas
SO (Standard Output) up to 3 ft or 1 m	225	738	700	DRVCC25SS277010	Americas only
SO (Standard Output) up to 3 ft or 1 m	225	738	1400	DRVCC50DALI1CH	Outside of Americas
SO (Standard Output) up to 6 ft or 1.5 m	225	738	1400	DRVCC50SS277010	Americas only
SO (Standard Output) up to 6 ft or 1.5 m	225	738	1400	DRVCC50DALI1CH	Outside of Americas
SO (Standard Output) up to 8 ft or 2.4 m	225	738	2750	DRVCC95SS277010	Americas only
SO (Standard Output) up to 8 ft or 2.4 m	225	738	2800	DRVCC96DALI1CH	Outside of Americas
HO (High Output) up to 2 ft or 0.5 m	325	1066	700	DRVCC25SS277010	Americas only
HO (High Output) up to 2 ft or 0.5 m	325	1066	1400	DRVCC50DALI1CH	Outside of Americas
HO (High Output) up to 4 ft or 1 m	325	1066	1400	DRVCC50SS277010	Americas only
HO (High Output) up to 4 ft or 1 m	325	1066	1400	DRVCC50DALI1CH	Outside of Americas
HO (High Output) up to 8 ft or 2.4 m	325	1066	2750	DRVCC95SS277010	Americas only
HO (High Output) up to 8 ft or 2.4 m	325	1066	2800	DRVCC96DALI1CH	Outside of Americas

**UNDERSTANDING THE MINIMUM BENDING RADIUS (MAXIMUM CURVATURE)**

The bending radius of a curve is the radius of the circle that would exist if the curve were extended to form a circle.

For example, we have a fixture of length L:



Let's bend this fixture. If we extend this curve to form a circle, we will see something like this:

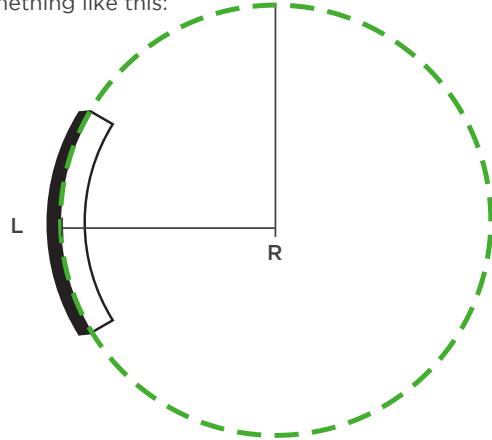

The radius R of that circle would be our curve's bending radius.

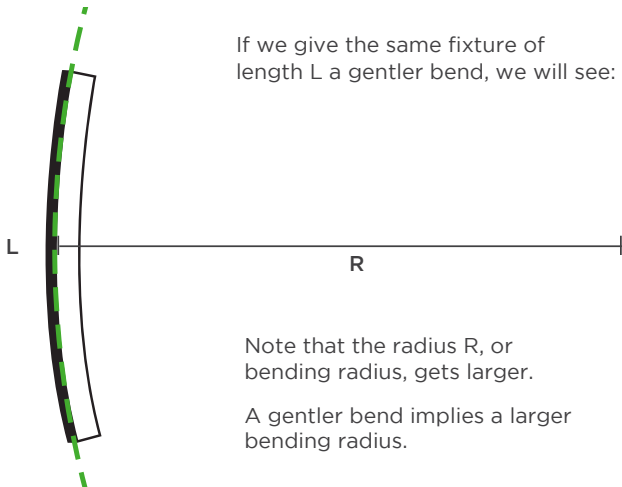

If we give the same fixture of length L a gentler bend, we will see:

Note that the radius R, or bending radius, gets larger.

A gentler bend implies a larger bending radius.

If we give the same fixture of length L a sharper bend, we will see:

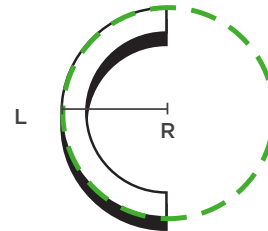

The radius R, or bending radius, gets smaller. A sharper bend implies a smaller bending radius.

We define a fixture's minimum bending radius because of this relationship; some of our fixtures are limited by the sharpness of the specified bend. A fixture's minimum bending radius defines the sharpest curve it can make without jeopardizing the integrity of the LED performance.

**Scroll35S Pendants have a minimum bending radius of 11.81 in. (300 mm)**

**Minimum Bending Radius = Maximum Curvature**

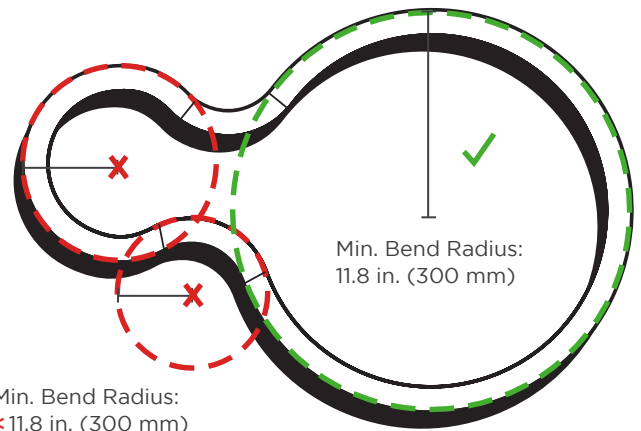

SUGGESTED SUSPENSION WIRE SEPARATED DISTANCES

SUGGESTED SUSPENSION WIRE SEPARATED DISTANCES

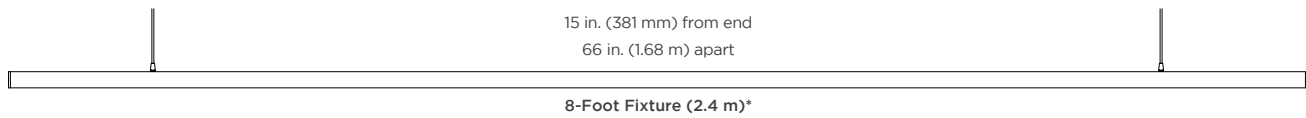
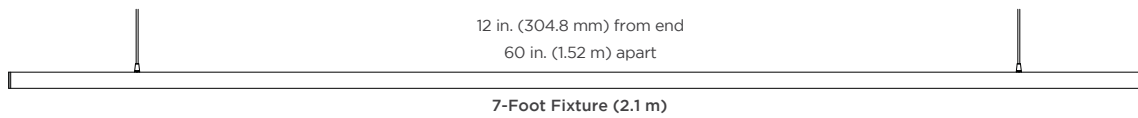
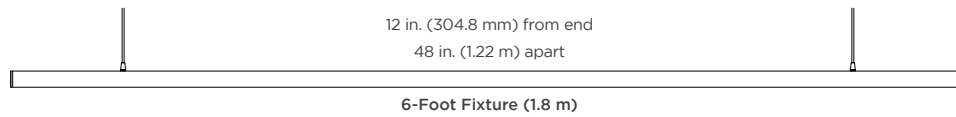
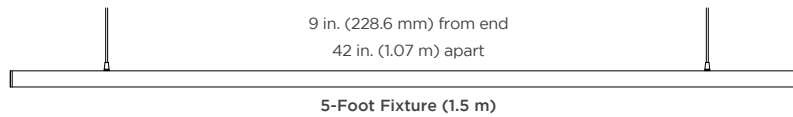
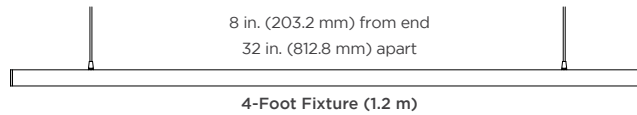
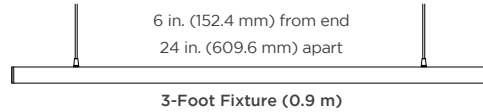
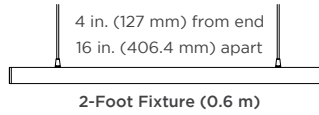

NOTE: Each section requires its own driver.

REV.29APR2026

**GLOBAL HQ**

320 Murray Hill Pkwy  
East Rutherford, NJ 07073  
U.S.  
T: (+1) 212 629 6830  
E: Sales-US@GENLEDBrands.com

**EUROPEAN HQ**

Hogeweyselaan 119  
1382 JK Weesp  
Netherlands  
T: (+31) 346 235 000  
E: SalesEurope@GENLEDBrands.com

**MEINA HQ**

PO Box 371378, #823, Building 4EA  
Dubai Airport Free Zone  
Dubai, UAE  
T: (+971) 4 701 7901  
E: SalesMEINA@genlebrands.com

**ASIA-PACIFIC HQ**

Room 402, Building D  
Shenshi Tongchuang Science and Technology Park  
No. 16 Hongyin Road  
Xingqiang Community, Xihu Street  
Guangming District, Shenzhen, China 518107  
T: (+86) 755 8529 0710  
E: Sales-Pacific@GENLEDBrands.com