

## THE PICCOLO FIXTURE

The Piccolo is a special micro fixture that stands just 0.23 in. (5.91 mm) high and 0.2 in. (5 mm) wide. The Piccolo uses a flat milky lens to create pinpoint lines of light in tight spaces such as custom millwork. It is sold in custom sizes ranging from 2.04 in. (51.7 mm) to 6 ft. 5.75 in. (1974.7 mm) long in increments of 1.52 in. (38.46 mm). The Piccolo features a special IP20 micro RibbonLyte that provides 90+ CRI in six available CCTs ranging from 2200K to 4000K.

- 3.0 W/ft (9.8 W/m)
- 0.2 in. (5 mm) wide by 0.23 in. (5.91 mm) high
- Fixture includes secure VHB tape backing
- Smallest fixture at 2.04 in. (51.7 mm) including end caps
- Sold in 1.52 in. (38.46 mm) increments up to 6 ft 5.75 in. (1974.7 mm)
- 110-degree beam angle
- Flat milky lens
- 55 LEDs/ft (182 LEDs/m)
- 90+ CRI
- IP20 rating for indoor use



## HOUSING FINISHES



Silver Standard    Black\*    Custom RAL\*

\* Consult factory. Additional fee and MOQ apply.

## AVAILABLE LENS FINISHES



Milky Lens  
63% Light Transmission



RoHS



## AVAILABLE COLOR TEMPERATURES



2200K    2400K    2700K    3000K    3500K    4000K

## DIMENSIONS

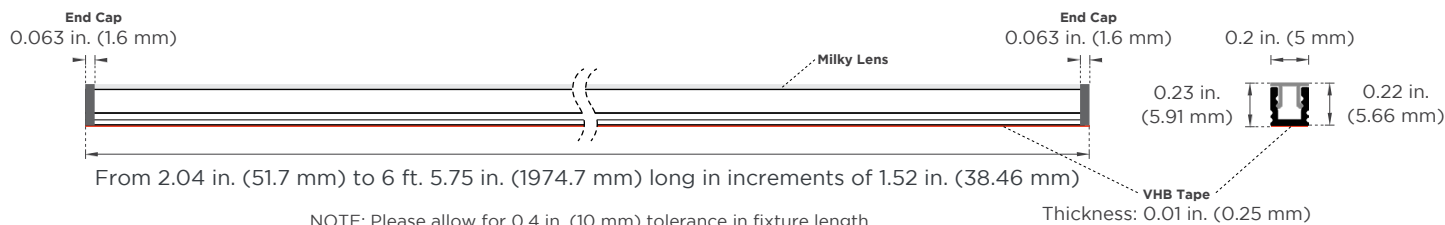

## ORDERING GUIDE

Model	Wattage	Color Temp.	LENS	HOUSING COLOR
PIC	3.0		M	
PIC - The Piccolo Fixture	3.0 - 3.0 W/ft (9.8 W/m)	22 - 2200K    30 - 3000K 24 - 2400K    35 - 3500K 27 - 2700K    40 - 4000K	M - Milky Lens	SV - Silver (default) BK - Black  Consult factory for custom colors. Additional fee and MOQ apply.

**NOTE:** The Piccolo is sold as a complete custom fixture. Cutting a Piccolo fixture in the field will void the warranty.



**SPECIFICATIONS**

<b>Beam Angle</b>	110°
<b>Lens Type</b>	Milky Lens
<b>Length</b>	Smallest fixture at 2.04 in. (51.7 mm) including end caps. Sold in 1.52 in. (38.46 mm) increments up to 6 ft 5.75 in. (1974.7 mm). Please allow for 0.4 in. (10 mm) tolerance in fixture length. (See dimension drawing at bottom of page 1 for reference.)
<b>Operating Voltage</b>	24V
<b>Dimming</b>	MLV / 0-10 Volt / ELV / DALI / DMX
<b>Operating Temperature</b>	-40° F to 158° F (-40° C to 70° C)
<b>Colors</b>	2200K, 2400K, 2700K, 3000K, 3500K, 4000K
<b>CRI</b>	90+ CRI
<b>Power Feed Option</b>	End feed
<b>Lamp Life</b>	L70 at 50,000 Hours
<b>MacAdam Ellipses (SDCM)</b>	2-Step Binning (For Static White LEDs only)
<b>Certifications</b>	UL Listed UL 2108 Issued: 2004/02/27 Ed: 1 Rev: 2014/02/24 Low Voltage Lighting Systems CSA C22.2#9.0 Issued: 1996/06/01 Ed: 1 (R2011) General Requirements for Luminaries; with Gen. Inst. 1: 1997, Gen Inst. 2: 1998. ROHS compliant

**RIBBONLYTE SPECIFICATIONS**

Cuttible Length	LED Pitch	Color Temperature	lm/W without Lens	Delivered Lumens with Milky Lens	Max Length
1.52 in. (38.46 mm)	55 LEDs/ft (182 LEDs/m)	<b>2200K</b>	72	136 lm/ft (447 lm/m)	6 ft 7 in. (2 m)
		<b>2400K</b>	77	146 m/ft (477 lm/m)	
		<b>2700K</b>	81	153 lm/ft (501 lm/m)	
		<b>3000K</b>	84	159 lm/ft (522 lm/m)	
		<b>3500K</b>	87	164 lm/ft (537 lm/m)	
		<b>4000K</b>	92	175 lm/ft (572 lm/m)	

**NOTE:** The Piccolo is sold as a complete custom fixture. Cutting a Piccolo fixture in the field will void the warranty.

24V DIMENSIONS	Top View	Side View	Dimensions
IP20	 <p>CUTTIBLE EVERY: 1.52 in (38.5 mm)</p>		<p><b>Width</b> 0.2 in (3 mm)  <b>Max Length</b> 6 ft 7 in. (2 m)  <b>Height</b> 0.06 in (1.45 mm)</p>

Acolyte does not warrant or represent that the information is free from errors or omission. The information may change without notice and Acolyte is not in any way liable for the accuracy of any information printed and stored or in any way interpreted or used.

AVAILABLE DRIVERS / CONTROLLERS AND DIMMING OPTIONS / WIRE GAUGE CHART

NON-DIMMING ELECTRONIC DRIVERS

ELV & MLV DRIVERS



**30W, 60W, 96W**  
Non-Dimming Electronic  
Class 2 Drivers

- Part No.:
- DRVW2430 (30 Watt)
  - DRVW2460 (60 Watt)
  - DRVW2496 (96 Watt)

Output Voltage: 24 V  
Voltage Range: 120-277 VAC  
IP Rating: Dry or Damp  
UL Listed



**240W, 320W**  
Non-Dimming  
Electronic Drivers

- Part No.:
- DRVW24240 (240 Watt)
  - DRVW24320 (320 Watt)

Output Voltage: 24 V  
Voltage Range: 90-305 VAC  
IP Rating: Dry or Damp  
UL Recognized



**60W, 96W, 150W, 300W**  
ELV/MLV Dimmable Drivers

- Part No.:
- DRVW2460ELVMLV (60 Watt)
  - DRVW2496ELVMLV (96 Watt)
  - DRVW24150ELVMLV (150 Watt)
  - DRVW24300ELVMLV (300 Watt)

Line Voltage Dimmable Drivers  
Output Voltage: 24 V  
Voltage Range: 100-277 VAC  
IP Rating: IP67  
Dimmable  
UL, CE, and CSA Listed

0-10V DRIVERS



**0-10V Dimmable Waterproof Drivers**

**96W** Part No.: DRVW249610P  
**288W** Part No.: DRVW2428810P  
Output Voltage: 24 V (+/- 0.5V)  
Voltage Range: 100-277 VAC  
Environmental Rating: UL Wet Location  
UL Listed

DRIVER AND RIBBONLYTE AT FULL LOAD

Wattages	30		60		96		150		200		240		300		320	
	Feet	Meters	Feet	Meters	Feet	Meters	Feet	Meters	Feet	Meters	Feet	Meters	Feet	Meters	Feet	Meters
24 AWG / 0.25 mm <sup>2</sup>	14	4.27	9	2.74	5.5	1.68	3.75	1.14	2.75	0.84	2.25	0.69	1.75	0.53	1.75	0.53
22 AWG / 0.34 mm <sup>2</sup>	22	6.71	14	4.27	9	2.74	5.75	1.75	4.5	1.37	3.5	1.07	2.75	0.84	2.75	0.84
20 AWG / 0.5 mm <sup>2</sup>	35	10.67	23	7.01	14	4.27	9	2.74	7	2.13	5.75	1.75	4.5	1.37	4.25	1.30
18 AWG / 0.75 mm <sup>2</sup>	56	17.07	37	11.28	23	7.01	15	4.57	11	3.35	9	2.74	7.5	2.29	7	2.13
16 AWG / 1.5 mm <sup>2</sup>	90	27.44	60	18.29	37	11.28	24	7.32	18	5.49	15	4.57	12	3.66	11	3.35
14 AWG / 2.5 mm <sup>2</sup>	142	43.29	95	28.96	59	17.99	38	11.59	28	8.54	23	7.01	19	5.79	17	5.18
12 AWG / 4 mm <sup>2</sup>	226	68.90	151	46.04	94	28.66	60	18.29	45	13.72	37	11.28	30	9.15	28	8.54
10 AWG / 6 mm <sup>2</sup>	360	109.76	240	73.17	150	45.73	96	29.27	72	21.95	60	18.29	48	14.63	45	13.72
8 AWG / 10 mm <sup>2</sup>	574	175.00	381	116.16	239	72.87	153	46.65	115	35.06	95	28.96	76	23.17	71	21.65

WIRING DIAGRAM

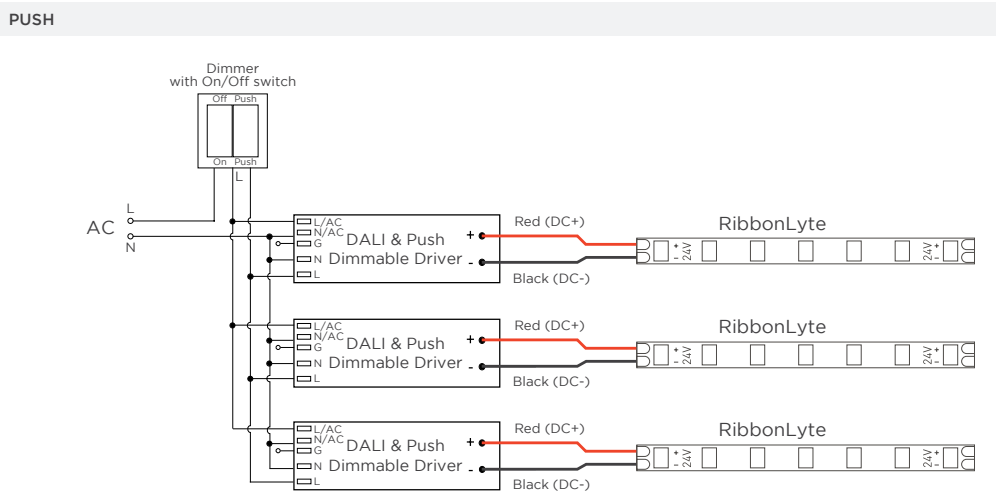
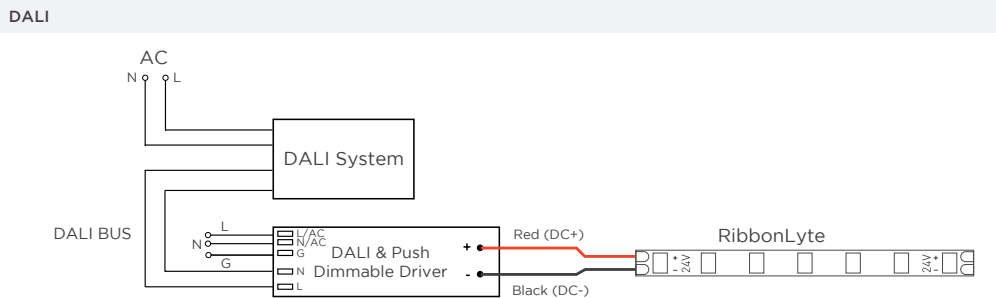
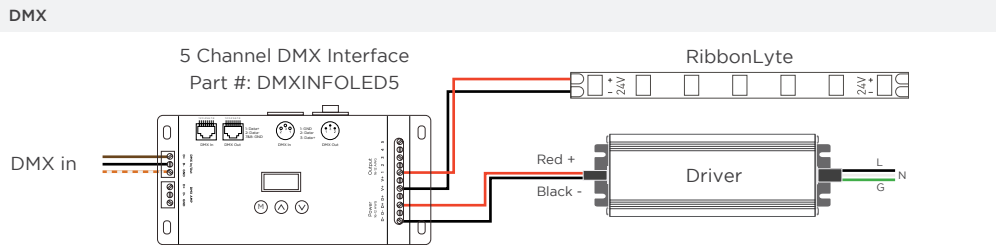
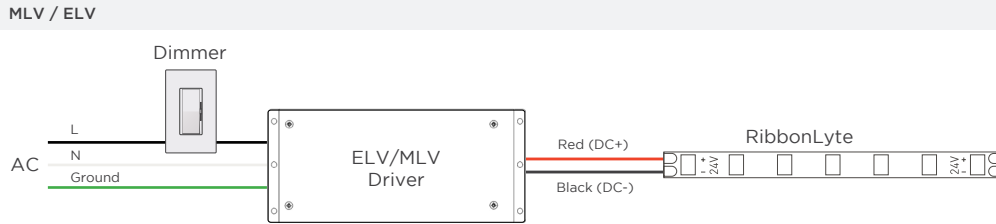
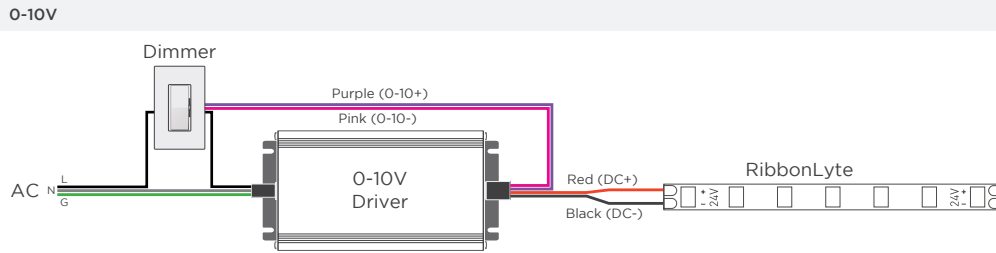

WIRE COLORS PER RIBBONLYTE COLOR

- STATIC WHITE
- Red Wire (+) Positive
- Black Wire (-) Negative