



**RGBW FLEXRAYZ NEON**

FlexRayz Neon from AgiLight offers a versatile approach to border tube that eliminates light gaps. A side-bending LED neon that provides an excellent solution for linear façade lighting in curved or straight runs, RGBW FlexRayz lets you tune your light to any of 16 million custom colors. Rated IP67 for use in damp and wet locations. FlexRayz products are designed to bend; use Aluminum Mounting Channel for straight run applications.



**Applications:**

- Borders and edges in signs and facades
- Neon replacements
- Cove and Accent lighting

**Features:**

- Available in pre-assembled 2 ft (0.61 m) or 8 ft (2.44 m) lengths or sold in full reels of 16.4 ft (5 m)
- Full reels can be cut and finished with an end cap; new power feeds cannot be introduced in the field
- 5.5 W/ft (18.04 W/m), 24 VDC
- RGB+6500K (4000K, 5000K upon request)
- 3.28 in. (83.3 mm) cut lengths
- 110x250° beam angle
- Use Aluminum Mounting Channel for straight runs
- Use S-type Track or Aluminum Mounting Clips for curves
- UV protected; saltwater, solvent & flame resistant
- IP67 ; IK08 impact protection
- Consistent brightness with constant current design
- Minimum bend radius of 1 in. (25 mm)



**ORDERING GUIDE**

Part Number	Length	Color	Lumens				
			All LEDs On	Red	Green	Blue	White
LB-FRN-RGBW65-2-A	2 ft / 0.61 m						
LB-FRN-RGBW65-8-A	8 ft / 2.44 m	RGB+6500K	55 lm/ft (180.4 lm/m)	7 lm/ft (23 lm/m)	19 lm/ft (62.3 lm/m)	3 lm/ft (9.8 lm/m)	25 lm/ft (82 lm/m)
LB-FRN-RGBW65-16-A	16 ft 4 in. / 5 m						
LB-FRN-RGBW50-2-A*	2 ft / 0.61 m						
LB-FRN-RGBW50-8-A*	8 ft / 2.44 m	RGB+5000K	55 lm/ft (180.4 lm/m)	7 lm/ft (23 lm/m)	19 lm/ft (62.3 lm/m)	3 lm/ft (9.8 lm/m)	25 lm/ft (82 lm/m)
LB-FRN-RGBW50-16-A*	16 ft 4 in. / 5 m						
LB-FRN-RGBW40-2-A*	2 ft / 0.61 m						
LB-FRN-RGBW40-8-A*	8 ft / 2.44 m	RGB+4000K	55 lm/ft (180.4 lm/m)	7 lm/ft (23 lm/m)	19 lm/ft (62.3 lm/m)	3 lm/ft (9.8 lm/m)	25 lm/ft (82 lm/m)
LB-FRN-RGBW40-16-A*	16 ft 4 in. / 5 m						

\* Special order only

**SPECIFICATIONS**

<b>Input Voltage</b>	24 VDC
<b>Power Consumption</b>	5.5 W/ft (18.04 W/m)
<b>Color</b>	RGB+6500K (special orders for RGB+5000K and RGB+4000K)
<b>Cutable Length</b>	3.28 in. (83.3 mm)
<b>Max. Length</b>	16.4 ft (5 m)
<b>Available Lengths</b>	2 ft (0.61 m) 8 ft (2.44 m) 16.4 ft (5 m)
<b>Min. Bending Radius</b>	1 in. (25 mm)
<b>Ingress Protection</b>	IP67
<b>Impact Protection Rating</b>	IK08
<b>Lifetime (L70 reported)</b>	50,000 hours @ 60 °C
<b>Warranty</b>	5-year limited warranty

**LUMINOUS INTENSITY DISTRIBUTION**

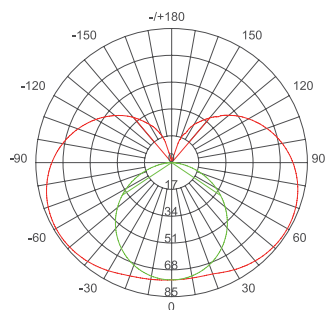

Average Beam Angle (50%): 182.2°

Unit: cd

- C0/180, 247.8°
- C90/270, 116.5°

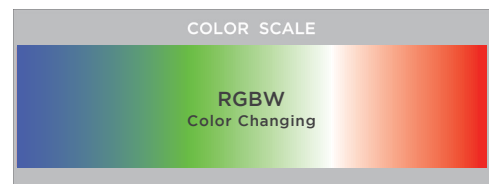



**DIMENSIONS**

	FlexRayz Neon	Front Bottom Feed End Cap	Closing End Cap (part #: LB-FRN-CAP)
<b>Length</b>	2 ft (0.61 m), 8 ft (2.44 m), and 16.4 ft (5 m)	0.94 in. (24 mm)	0.94 in. (24 mm)
<b>Width</b>	0.55 in. (14 mm)	0.55 in. (14 mm)	0.55 in. (14 mm)
<b>Height</b>	1.06 in. (27 mm)	1.54 in. (39 mm)	1.06 in. (27 mm)

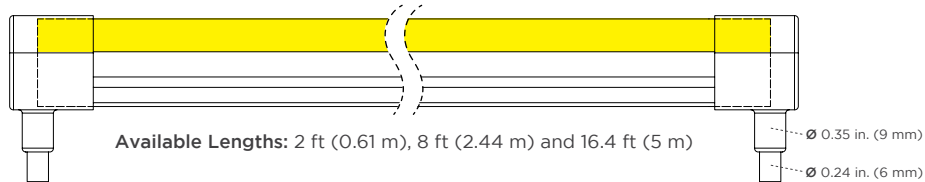

RGBW FlexRayz Neon if cut						
Standard Length (ft)	Actual Light Length		Actual Length with End Caps		Channel Cut Length	
	(ft)	(m)	(ft)	(m)	(ft)	(m)
<b>Single End Feed</b>						
2	1.91	0.58	1.99	0.61	1.76	0.54
8	7.93	2.42	8	2.44	7.77	2.37
16	15.85	4.83	15.93	4.85	15.7	4.79
<b>Double End Feed</b>						
2	1.91	0.58	2.07	0.63	1.76	0.54
8	7.93	2.42	8.08	2.46	7.77	2.37
16	15.85	4.83	16	4.88	15.7	4.79

**Minimum Bending Radius**

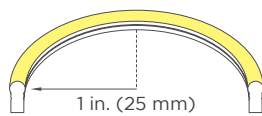

**Bending Direction**

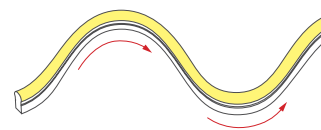

**ACCESSORIES**

	Closing End Cap	Aluminum Mounting Clip for mounting in curved sections only	S-type Track for mounting in curved sections	Aluminum Channel for mounting in straight sections	0.5 in. Standoff for mounting above facade surface
<b>Part No.</b>	LB-FRN-CAP	LB-FRN-CLIPMNT	LB-FRN-CRVMNT	LB-FRN-CHMNT-2	LB-FRN-STDOFF
<b>Length</b>	0.63 in. (16 mm)	0.98 in. (25 mm)	19.7 in. (500 mm)	78.7 in. (2000 mm)	0.38 in. (9.5 mm)
<b>Width</b>	0.67 in. (17 mm)	0.6 in. (15.3 mm)	0.6 in. (15.3 mm)	0.48 in. (12.3 mm)	0.38 in. (9.5 mm)
<b>Height</b>	1.24 in. (31.5 mm)	0.83 in. (21 mm)	0.83 in. (21 mm)	0.67 in. (17 mm)	0.5 in. (12.7 mm)

**TO ATTACH END CAPS:** When sealing FlexRayz Neon end caps, use a neutral cure (non-acetoxy) silicone adhesive that is non-corrosive and safe for LEDs and electronic circuitry. **DO NOT** use acetoxy (acid-cure) silicone to seal end caps. Acetoxy silicone releases acetic acid that can damage LEDs and electronic components.



**POWER SUPPLY LOADING**

Product	Power Supply (W)	Max. # of ft/m in a continuous run	Total # of ft/m per power supply NOT in a continuous run
RGBW FlexRayz Neon	60	9.8 / 3	9.8 / 3
	100	16.4 / 5	16.4 / 5
	300	3 outputs: 16.4 / 5 per output	49.1 / 15 (3 outputs: 16.4 / 5 per output)

**AVAILABLE POWER SUPPLIES**



**30W 24V  
POWER SUPPLY**  
Part #: PS24-30W-GN  
Article #: 28000516A



**100W 24V  
POWER SUPPLY**  
Part #: PS24-100W-GN  
Article #: 28000513A



**60W 24V  
POWER SUPPLY**  
Part #: PS24-60W-GN  
Article #: 28000512A



**300W 24V  
POWER SUPPLY**  
Part #: PS24-300W-3-GN  
Article #: 28000514A

**AVAILABLE CONTROLS**



**GLASS TOUCH  
WALL CONTROLLERS**  
Part #: AWCRGBWWBK



**5 ZONE  
WALL CONTROLLER**  
Part #: DMXCTRL



**10 ZONE  
WALL CONTROLLER**  
Part #: DMXCTRLD



**5 CHANNEL  
DMX DECODER**  
Part #: DMXINF5



**4 CHANNEL WATERPROOF  
DMX INTERFACE**  
Part #: DMXINFWLCD4



**4 ZONE RGBW  
RF REMOTE**  
Part #: RFREMOTERGBW4Z



**4 CHANNEL  
RF INTERFACE**  
Part #: RFINTERFACE4CH

**CONNECTIONS**

**WIRELESS RF**

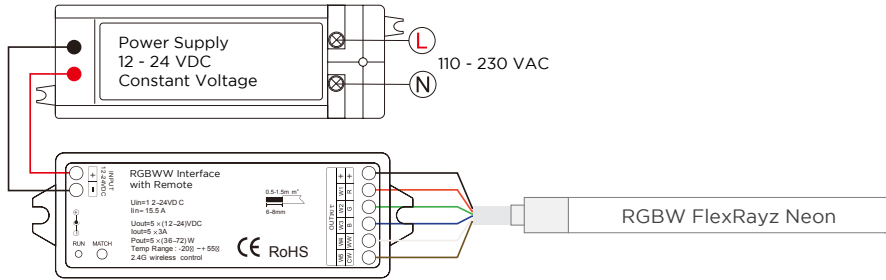

**WARNING**

- DO NOT Install with power applied to device
- DO NOT expose the device to moisture



**PROGRAMMING GUIDE**

**Use the Match key**

**1. Match:**

Quickly press the Interface match key. Within 5 seconds, press the Remote On/Off key

**2. Delete:**

Press the Interface match key for 5 seconds to delete any matched Remotes.

**Power-up**

**1. To match:**

Switch the power off, then on. Within 5 seconds, quickly press the On/Off key on the Remote 3 times. When the light blinks 3 times, the match is confirmed.

**2. To delete:**

Switch the power off, then on. Within 5 seconds, quickly press the On/Off key on the Remote 5 times. When the light blinks 5 times, the match is deleted.

**DMX**

**FLEXRAYZ NEON WIRE COLORS**

- Black (+) Positive
- Red Wire (-) goes to Red Channel
- Green Wire (-) goes to Green Channel
- Blue Wire (-) goes to Blue Channel
- White Wire (-) goes to White Channel

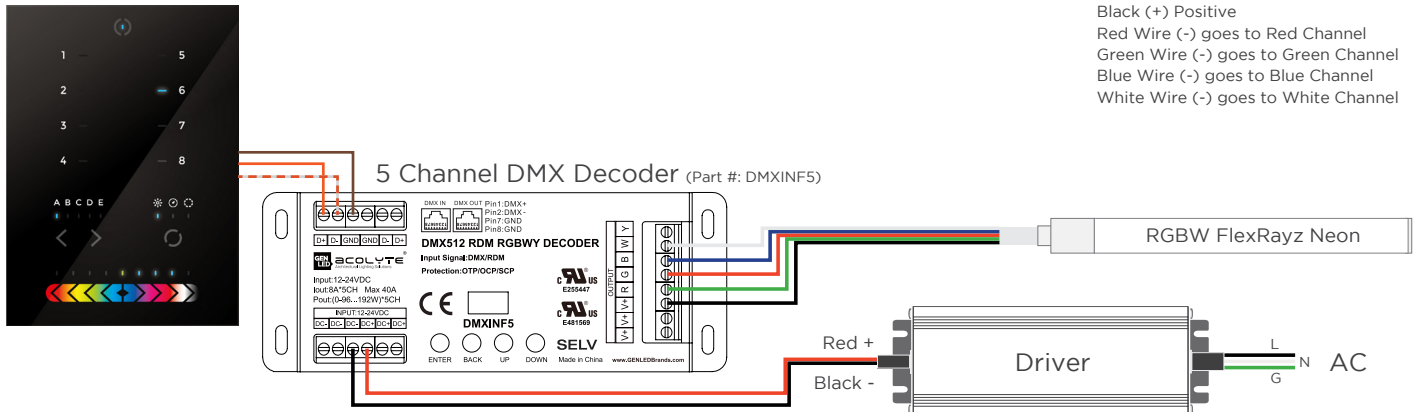

**GLOBAL HQ**

320 Murray Hill Pkwy  
East Rutherford, NJ 07073  
U.S.  
T: (+1) 212 629 6830  
E: Sales-US@GENLEDBrands.com

**EUROPEAN HQ**

Hogeweyselaan 119  
1382 JK Weesp  
Netherlands  
T: (+31) 346 235 000  
E: SalesEurope@GENLEDBrands.com

**MEINA HQ**

PO Box 371378, #823, Building 4EA  
Dubai Airport Free Zone  
Dubai, UAE  
T: (+971) 4 701 7901  
E: SalesMEINA@genlebrands.com

**ASIA-PACIFIC HQ**

Room 402, Building D  
Shensi Tongchuang Science and Technology Park  
No. 16 Hongyin Road  
Xingqiang Community, Xiniu Street  
Guangming District, Shenzhen, China 518107  
T: (+86) 755 8529 0710  
E: Sales-Pacific@GENLEDBrands.com