

60W 12V POWER SUPPLY WITH ENCLOSURE

This constant voltage Class 2 60W driver is UL and FCC listed. It is rated for wet, damp, and dry locations and has an enclosure with isolated wire connections. With input voltage ranging from 100-277 VAC, this driver is suited for commercial, industrial and residential applications.

- Constant voltage
- 100-277 VAC input voltage range
- Built-in PFC function
- Short circuit, over voltage and over heating protections
- PF > 0.99
- Efficiency > 88%
- Suitable for dry, damp and wet locations
- UL/cUL, FCC listed, Class 2, Class P, Type HL
- 7-year warranty



RoHS SELV

PRODUCT INFORMATION

Type	PS12-60W-100-277V-ENC-B
Rated Input Voltage	100-277 VAC
Rated Input Frequency	47-63 Hz
AC Input Current	0.93 A @ 120 VAC
Rated Output Power	12 VDC
Rated Power	60 W
Inrush Current	50 A
Output Current	5 A DC
Efficiency	> 85% @ 110 VAC, 100% load > 86% @ 277 VAC, 100% load
Typical Power Factor	0.98 @ 120 VAC 0.95 @ 277 VAC
Environment Rating	Dry, damp or wet locations
Ambient Temp.	-40 – 140° F (-40 – 60° C)
Storage Temp.	-40 – 176° F (-40 – 80° C)
Lifetime	50,000 hrs @ Tc 85 °C (60 °C ambient)
Dimensions (L x W x H)	7.4 x 3.72 x 1.57 in. (188 x 94.5 x 40 mm)
Net Weight	2.43 lb (1.1 kg)

STANDARD COMPLIANCE

Safety	Safety Standards
UL / cUL	UL8750 + UL1310
EMC	
Withstand Voltage	I/P-O/P:2.2K VAC
Isolation Resistance	I/P-O/P: 100 MΩ/500 VDC/77 °F (25 °C)/70% RH
EMC Emission	FCC Part 15 B
EMC Immunity	
	EN55015 Compliant EN61000-4-2,3,4,5,6,8,11 EN61547 Alight industry level (surge 4KV)

DIMENSION DRAWINGS

L x W x H

7.4 x 3.72 x 1.57 in.
(188 x 94.5 x 40 mm)

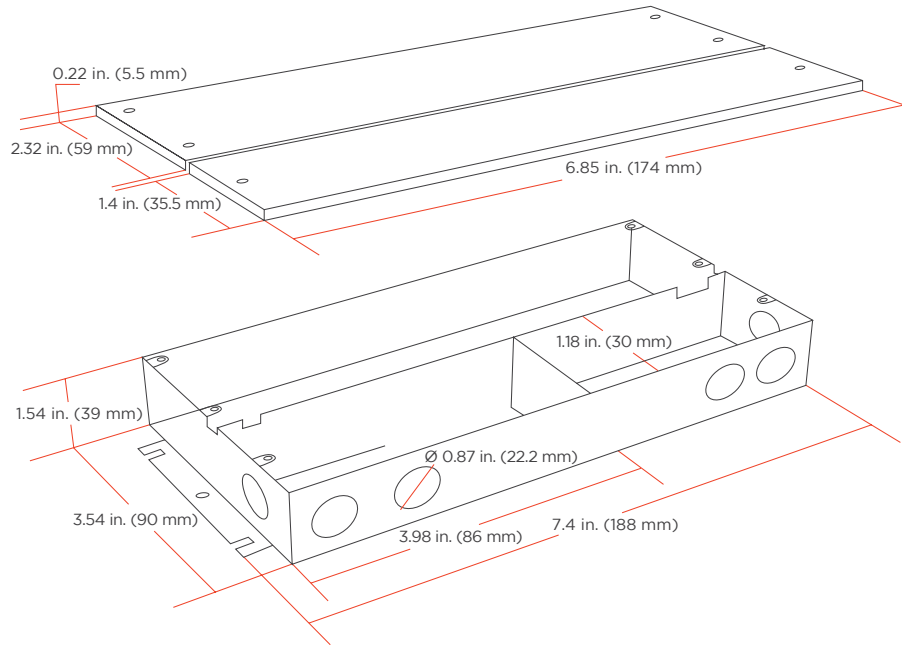

NOTE: To prevent exposure to the maximum allowable temperatures for these drivers, the suggested installation spacing between drivers is at least 4 in. (101.6 mm) side-to-side when the distance to the sidewall and top of the enclosure is 2 in. (50.8 mm). When the distance to the sidewall and top of the enclosure is 6 in. (152.4 mm), maintain at least 2 in. (50.8 mm) side-to-side spacing between drivers. Drivers should be placed at a minimum of 1 in. (25.4 mm) apart when arranging them end-to-end regardless of the enclosure size.

CONNECTION

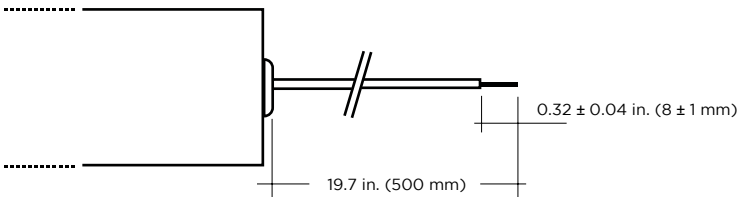

Primary Cable			Secondary Cable	
L	N	PE	+	-
black	white	green	red	black

WIRING DIAGRAM

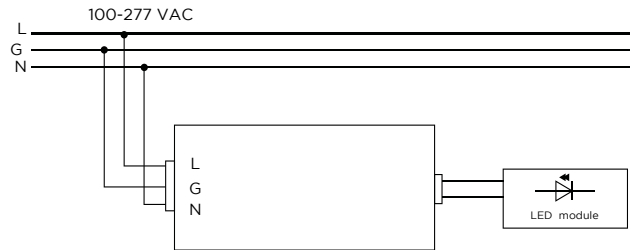

Installation instructions

The switching of LEDs on secondary side is not permitted. A proper functioning of the LCU in combination with third party dimming devices (e.g. PWM) cannot be guaranteed.

SHIPPING INFORMATION

Module Type	Specs	Packaging Quantity	
		Per SKU	Per Case
PS12-60W-100-277V-ENC-B	# of Units	1	20

DRIVER REMOTE DISTANCES

Wattages Wire Gauge	PS12-60W-100-277V-ENC-B	
	Feet	Meters
24 AWG / 0.20 mm ²	2.48	0.758
22 AWG / 0.33 mm ²	4.21	1.282
20 AWG / 0.52 mm ²	6.43	1.961
18 AWG / 0.82 mm ²	10.41	3.175
16 AWG / 1.31 mm ²	16.82	5.128
14 AWG / 2.08 mm ²	26.67	8.130
12 AWG / 3.31 mm ²	42.05	12.821
10 AWG / 5.26 mm ²	66.26	20.202
8 AWG / 8.37 mm ²	104.13	31.746

NOTE: Calculations include a standard 10% buffer

**Lifetime Vs. Case Temperature
 (120 VAC)**

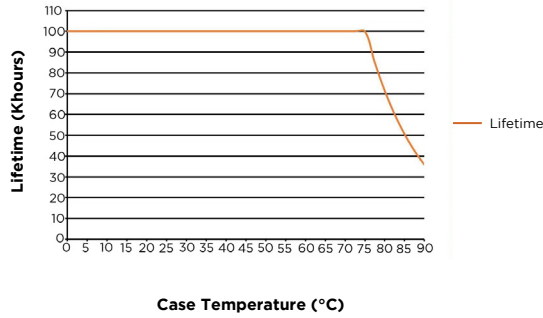

**Lifetime Vs. Case Temperature
 (277 VAC)**

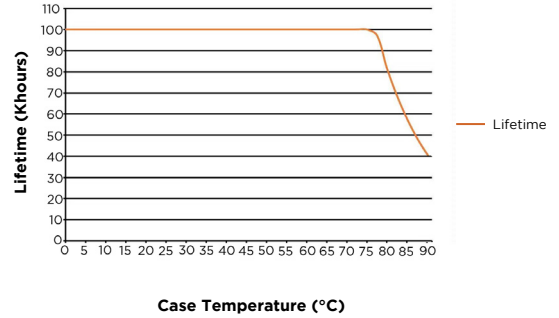

Efficiency Vs. Output Power

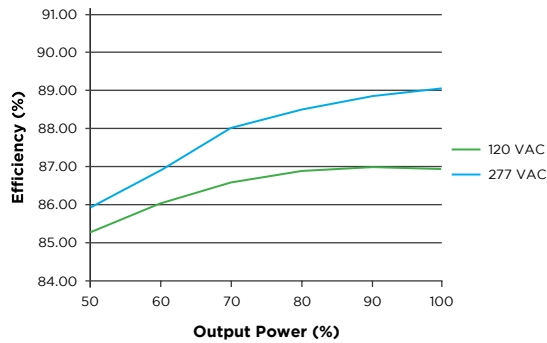

Output Power Vs. Ambient Temperature

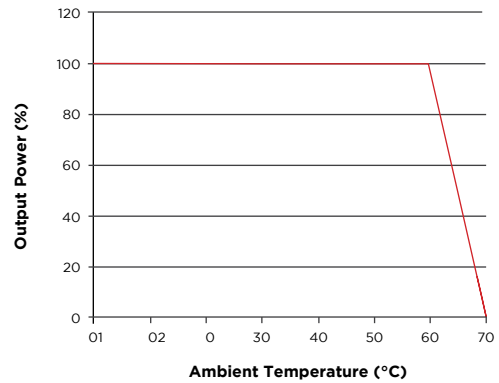

1. The maximum case temperature Tc shall not exceed 185 °F (85 °C) when used in end product.
2. These products are intended to be connected to a max. 20A branch circuit.
3. These products are intended for use in dry and damp locations.
4. Required spacing between power supply according to UL48.

REV.16.JAN2025

GLOBAL HQ

320 Murray Hill Pkwy
 East Rutherford, NJ 07073
 U.S.
 T: (+1) 212 629 6830
 E: Sales-US@GENLEDBrands.com

EUROPEAN HQ

Hogeweyselaan 119
 1382 JK Weesp
 Netherlands
 T: (+31) 346 235 000
 E: SalesEurope@GENLEDBrands.com

MEINA HQ

PO Box 371378, #823, Building 4EA
 Dubai Airport Free Zone, Dubai, UAE
 T: (+971) 4 701 7901
 E: SalesMEINA@genlebrands.com

ASIA-PACIFIC HQ

Room 402, Building D
 Shenshi Tongchuang Science and Technology Park
 No. 16 Hongyin Road
 Xingqiang Community, Xihu Street
 Guangming District, Shenzhen, China 518107
 Sales: (+86) 139 1836 3905
 Office: (+86) 755 8529 0710
 E: Sales-Pacific@GENLEDBrands.com