

#### Product Description:

- Constant voltage LED power supply
- Universal input voltage range
- Three 60W channels
- 0.5 in. NPT threaded connector for AC input
- Encapsulated metal casing
- Nominal lifetime up to 70,000 hours
- Suitable for emergency installations (EN 50172)
- Complies with Class C (EN 61000-3-2)
- 7-year warranty

#### Properties:

- High efficiency
- Overtemperature, overload protection
- Short-circuit shutdown feature with automatic restart
- Surge protection
- IP68 rating for dry, damp and wet use



#### ORDERING GUIDE

Type	PS12-180W-3-GN
Article Number	28000515A
Packaging Carton	10 pc(s).
Package Dimensions (L x W x L)	12.6 x 3.94 x 1.77 in. (320 x 100 x 45 mm)
Weight per pc.	3.3 lb (1.35 kg)
Carton Dimensions (L x W x L)	20.28 x 13.19 x 4.33 in. (515 x 335 x 110 mm)
Carton Weight	32 lb (14.5 kg)

#### SPECIFIC TECHNICAL DATA

Type	PS12-180W-3-GN
Max. Casing Temp T <sub>c</sub>	203° F (95° C)
Output Voltage	12 V
Max. Input Power	200 W
Output Current Range	0-5 A x 3 Channels
Max. Output Voltage	13.2 V

#### STANDARD COMPLIANCE

<b>Safety</b>	<b>Safety Standards</b>
<b>Certifications</b>	UYMR2, CE, RoHS, FCC

#### TECHNICAL DATA

Rated Supply Voltage	100-277 VAC
Input Voltage, AC	90-305 VAC
Input Voltage, DC	200-240 VDC
Max input current	2.5 A
Mains Frequency	0 / 50 / 60 Hz
Efficiency (at 230 V, 50 Hz, full load)	≥ 92%
λ (at 230 V, 50 Hz, full load)	0.95
THD	< 20%
Output Voltage Tolerance	-/+ 5%
Output Power (T <sub>a</sub> ≤ 60° C)	60 W x 3 Channels
Output Power Range	0 - 180 W
No Load Power	
Inrush Current (cold start 230VAC/50Hz)	< 100 A
Turn On Time (Output)	> 0.5 s
Hold on Time at Power Failure (Output)	10 ms
Ambient Temperature T <sub>a</sub>	-40° — +140° F (-40 ~ +60° C)
Ambient Temperature T <sub>a</sub> (at life-time 70,000 hrs)	-40° — +122° F (-40 ~ +50° C)
Storage Temperature T <sub>s</sub>	-40° — +176° F (-40 ~ +80° C)
Dimensions (L x W x H)	10.28 x 3.46 x 1.5 in. (261 x 88 x 38 mm)

**DIMENSION DRAWINGS**

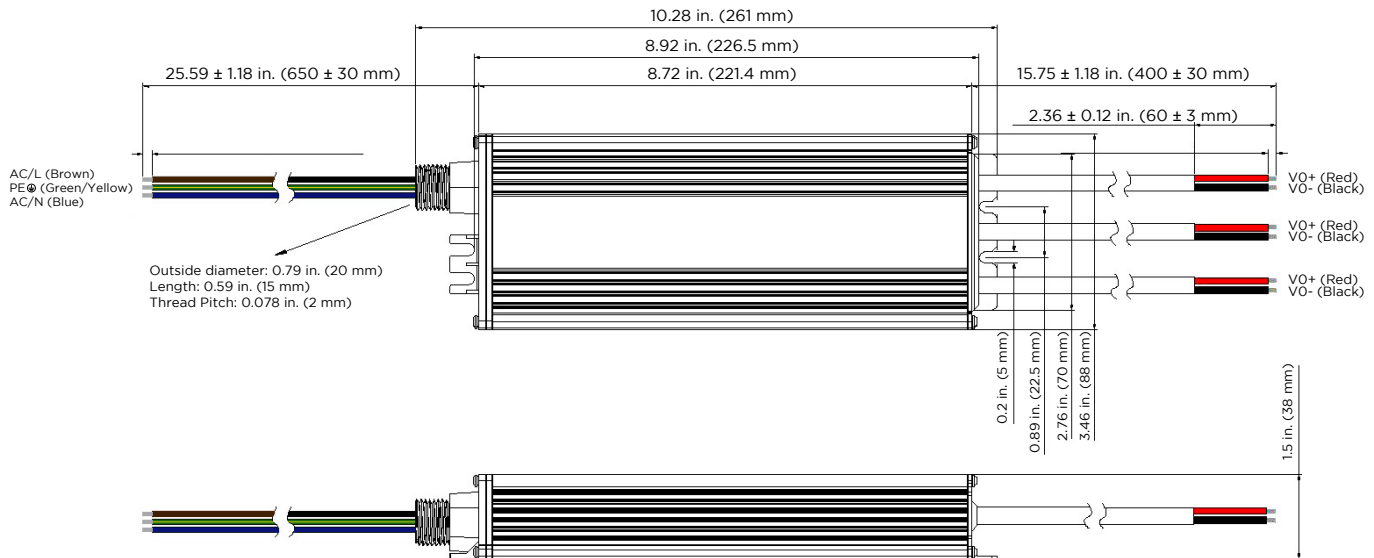

**Note:** To prevent exposure to the maximum allowable temperatures for these drivers, the suggested installation spacing between drivers is at least 4 in. (100 mm) side-to-side when the distance to the sidewall and top of the enclosure is 2 in. (50 mm). When the distance to the sidewall and top of the enclosure is 6 in. (150 mm), maintain at least 2 in. (100 mm) side-to-side spacing between drivers. Drivers should be placed a minimum of 1 in. (25 mm) apart when arranging them end-to-end regardless of the enclosure size.

**CONNECTION**

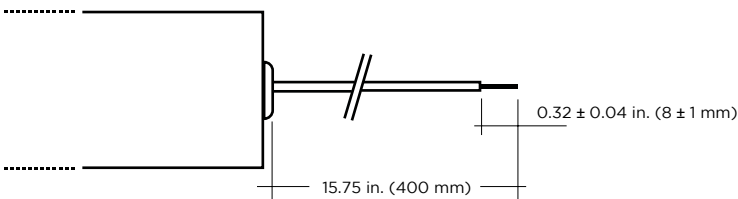

**WIRING DIAGRAM**

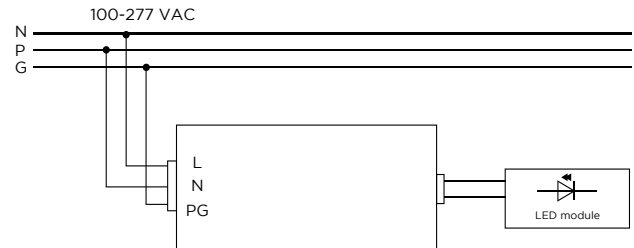

Primary Cable			Secondary Cable	
L	N	PG	+	-
brown	blue	green/yellow	red	black

DRIVER REMOTE DISTANCES		
Wattages	PS12-180W-3-GN	
Wire Gauge	Feet	Meters
24 AWG / 0.20 mm <sup>2</sup>	2.48	0.758
22 AWG / 0.33 mm <sup>2</sup>	4.21	1.282
20 AWG / 0.52 mm <sup>2</sup>	6.43	1.961
18 AWG / 0.82 mm <sup>2</sup>	10.41	3.175
16 AWG / 1.31 mm <sup>2</sup>	16.82	5.128
14 AWG / 2.08 mm <sup>2</sup>	26.67	8.130
12 AWG / 3.31 mm <sup>2</sup>	42.05	12.821
10 AWG / 5.26 mm <sup>2</sup>	66.26	20.202
8 AWG / 8.37 mm <sup>2</sup>	104.13	31.746

**NOTE:** Calculations include a standard 10% buffer

**PERFORMANCE CURVE**

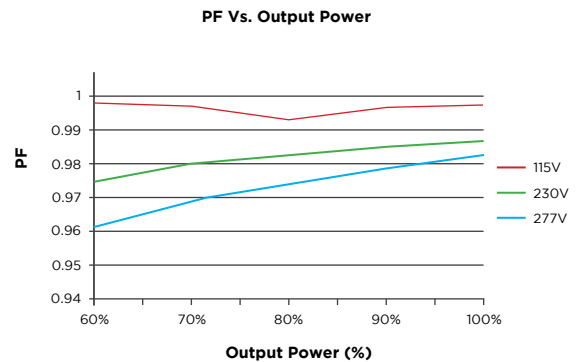
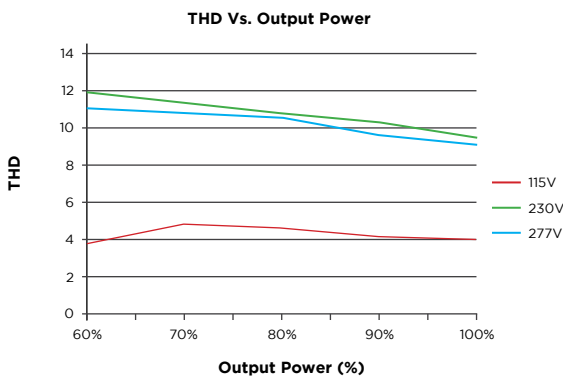
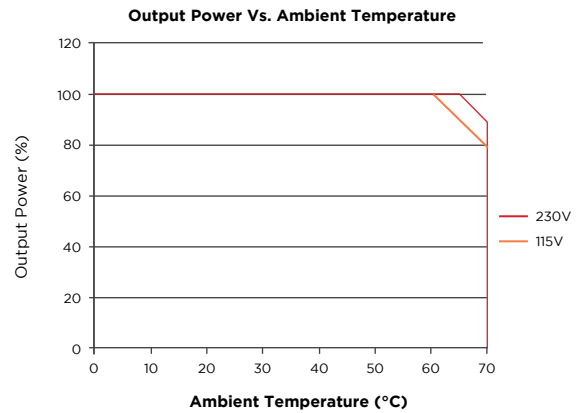
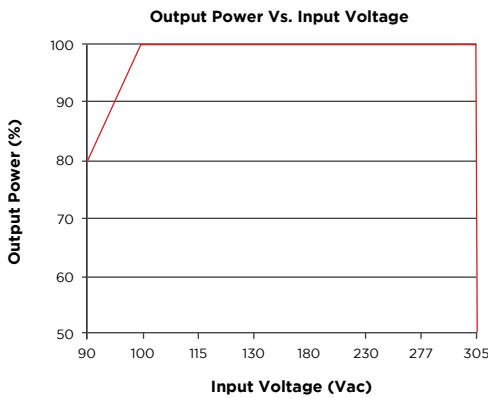
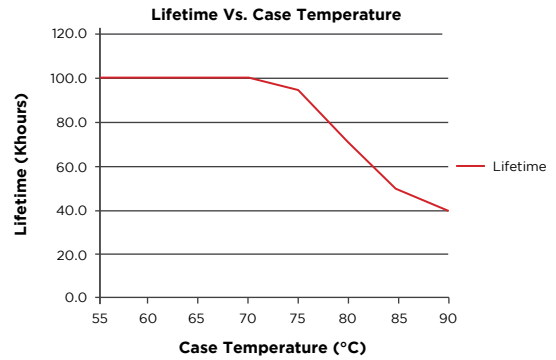
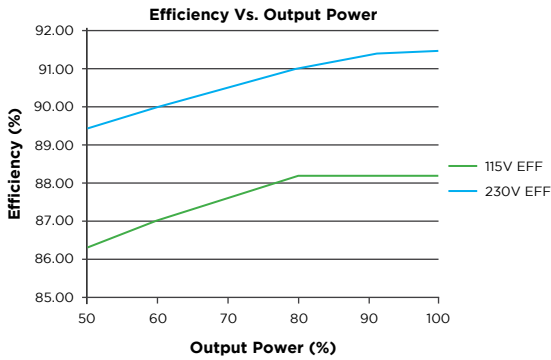

1. The maximum case temperature Tc shall not exceed 194°F (90°C) when used in end product.
2. These products are intended to be connected to a max. 20 A branch circuit.
3. These products are intended for use in dry and damp locations.
4. **Required spacing between power supply according UL48.**