



Date _____ Project _____

Notes _____

NEON360

Neon360 is a bendable LED neon tube with a round profile that provides uniform light distribution. With a one-inch (0.91 in./23 mm) diameter, the striking 24V Neon360 is available in 5 dimmable Static White CCTs (2400K-4000K). Neon360 offers flexible design with a bending diameter of 4.72 in. (120 mm) and cut lengths of less than 2 in. (50 mm). Choose from several unique mounting options for creative light displays.

- Fully illuminated flexible round LED neon
- 0.91 in. (23 mm) diameter
- 5 Static White CCTs (2400K-4000K)
- Min. bending diameter: 4.72 in. (120 mm)
- 4.8 W/ft (16 W/m), cuttable every 1.4 in. (35.71 mm)
- 389.9 lm/ft (1278.9 lm/m) @ 4000K

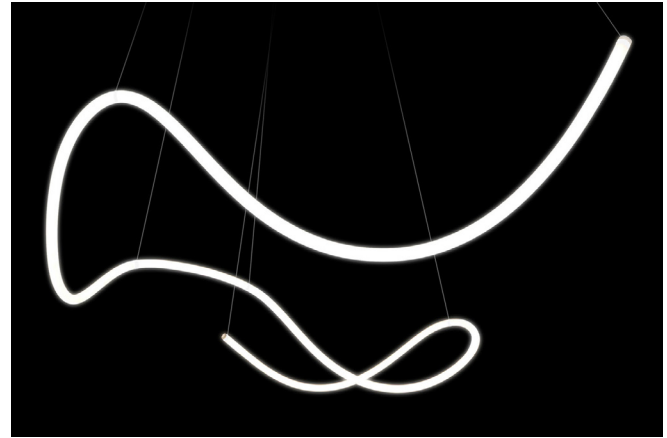

AVAILABLE COLORS AND COLOR TEMPERATURES

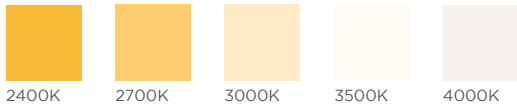

ORDERING GUIDE

Category	Wattage & Color		Power Feed Direction
NL360			
NL360 - Neon360	4.824 - 4.8 W/ft 2400K	4.835 - 4.8 W/ft 3500K	E - End Feed
	4.827 - 4.8 W/ft 2700K	4.840 - 4.8 W/ft 4000K	S - Side Feed
	4.830 - 4.8 W/ft 3000K		

ACCESSORIES

- | | | |
|--|---|--|
| <p>1. Mounting Clip (set of 2)
Part #: NL360MC</p> <p>2. Mounting Channel
Part #: NL360CH</p> <p>3. End Cap
Part #: NL360CAP</p> <p>4. Coupler Kit
Part #: NL360COUP</p> | <p>5. Ceiling Mounting Kit
Part #: NL360CMNT</p> <p>6. Ceiling Mounting Kit with Clear Rigid Tube
Part #: NL360CMNTPC</p> <p>7. Vertical Suspended Mounting Kit
Part #: NL360VMNT</p> <p>8. Vertical Suspended Mounting Kit with Clear Rigid Tube
Part #: NL360VMNTPC</p> | <p>9. Horizontal Suspended Mounting Kit with Clear Rigid Tube
Part #: NL360HSUSPC</p> <p>10. Horizontal Suspended Mounting Kit with Mounting Channel
Part #: NL360HSUSCH
Add appropriate number of non-feed channel sections for fixtures longer than 6.74 in. (2 m)
Part #: NL360HSUSCHNF</p> <p>11. Mounting Ring Kit with Steel Cable
Part #: NL360HOOK
(Canopy Kit not included)</p> <p>12. Canopy Kit
Part #: NL360CANOPY</p> |
|--|---|--|

NOTE: Standard suspension cables are 39.37 in. (1 m) long. Order custom suspension cables up to 16 ft 4.85 in. (5 m) or longer.

DIMENSIONS

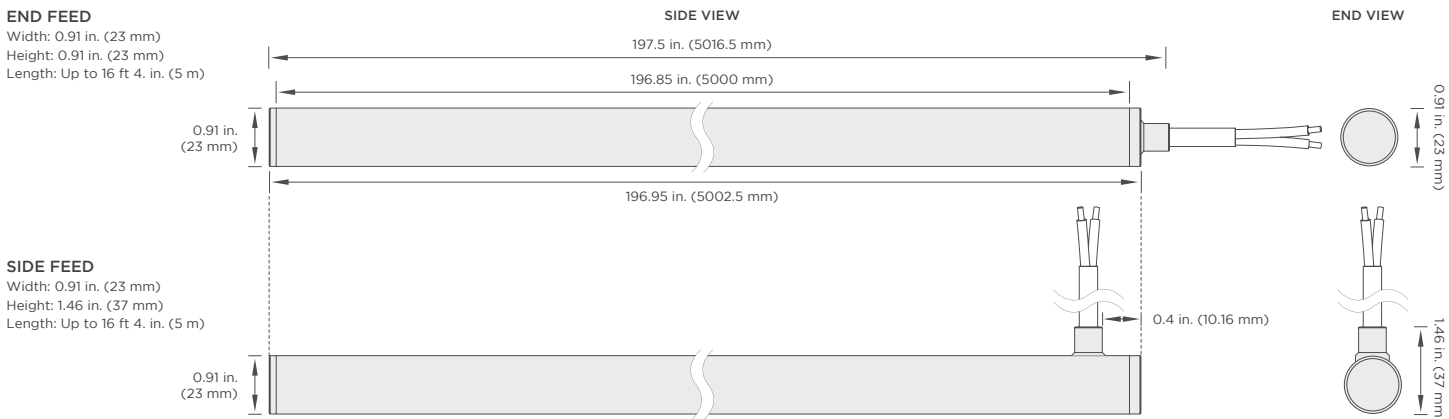

SPECIFICATIONS

SPECIFICATIONS		NEON360				
Operating Voltage	24 V					
Power Consumption	4.8 W/ft (16 W/m)					
Beam Angle	360°					
Protection Rating	IP65					
Dimming	MLV / 0-10V / ELV / DALI / DMX					
Operating Temperature	-4° F to 140° F (-20° C to 60° C)					
Color Temperatures	2400K	2700K	3000K	3500K	4000K	
Lumens	298.1 lm/ft (978 lm/m)	352.3 lm/ft (1155.9 lm/m)	378.2 lm/ft (1240.9 lm/m)	388.8 lm/ft (1275.7 lm/m)	389.8 lm/ft (1278.9 lm/m)	
Efficacy	62.1 lm/W	73.4 lm/W	78.8 lm/W	81 lm/W	81.2 lm/W	
Lamp Life	50,000 Hours					
Length	Up to 16 ft 4. in. (5 m)					
Cutable Length	1.4 in. (35.71 mm) NOT FIELD CUTTABLE					
Minimum Bending Diameter	4.72 in. (120 mm)					
Suspension Cable Length	Standard suspension cables are 39.37 in. (1 m) long. Order custom suspension cables up to 16 ft 4.85 in. (5 m) or longer.					
CRI (Static White)	80+ CRI					



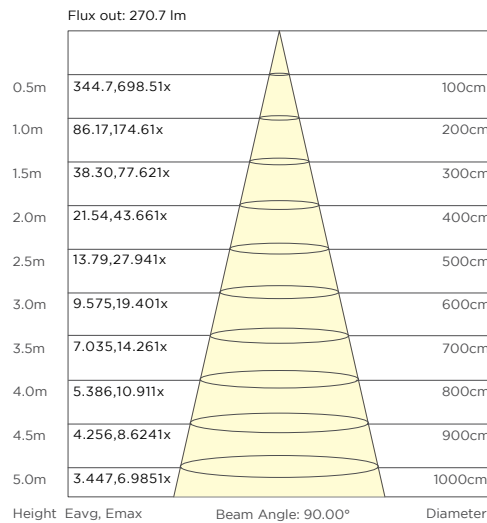



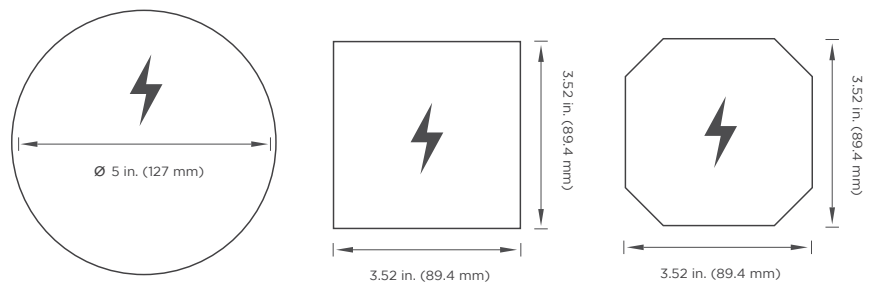





AVERAGE ILLUMINANCE @ 4000K



JUNCTION BOX MAXIMUM DIMENSIONS FOR CANOPY COVERING

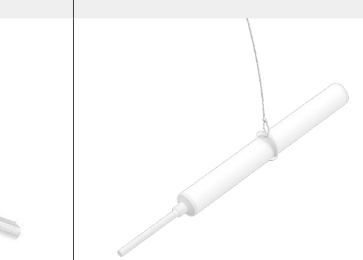

ACCESSORIES

<p>Mounting Clip (set of 2)</p>  <p>Part #: NL360MC</p>	<p>Mounting Channel</p>  <p>Part #: NL360CH</p>	<p>End Cap</p>  <p>Part #: NL360CAP</p>	<p>Coupler Kit</p>  <p>Part #: NL360COUP</p>
<p>Ceiling Mounting Kit</p>  <p>Part #: NL360CMNT</p>	<p>Ceiling Mounting Kit with Clear Rigid Tube*</p>  <p>Part #: NL360CMNTPC</p> <p>* Clear Rigid Tube is to keep Neon360 in a straight line and is not bendable, and the max length is 78.7 in. (2 m).</p>	<p>Vertical Suspended Mounting Kit</p>  <p>Part #: NL360VMNT</p>	<p>Vertical Suspended Mounting Kit with Clear Rigid Tube*</p>  <p>Part #: NL360VMNTPC</p> <p>* Clear Rigid Tube is to keep Neon360 in a straight line and is not bendable, and the max length is 78.7 in. (2 m).</p>
<p>Horizontal Suspended Mounting Kit with Clear Rigid Tube*</p>  <p>Part #: NL360HSUSPC</p> <p>* Clear Rigid Tube is to keep Neon360 in a straight line and is not bendable, and the max length is 78.7 in. (2 m).</p>	<p>Horizontal Suspended Mounting Kit with Mounting Channel</p>  <p>Part #: NL360HSUSCH</p> <p>NOTE: Neon360 fixtures can run up to 16.4 ft (5 m) long. Each section of mounting channel is a maximum of 6 ft 6.74 in. (2 m). Channel sections are pre-cut and pre-assembled. For complete fixtures longer than 6.74 in. (2 m), add the appropriate number of extra non-feed channel sections to reach desired length.</p> <p>Non-feed Part #: NL360HSUSCHNF</p>	<p>Mounting Ring Kit with Steel Cable**</p>  <p>Part #: NL360HOOK</p> <p>** To maintain a horizontal fixture, ring suspension points should be spaced every 15 in. (Canopy Kit not included)</p>	<p>Canopy Kit</p>  <p>Part #: NL360CANOPY</p>

NOTE: Standard suspension cables are 39.37 in. (1 m) long. Order custom suspension cables up to 16 ft 4.85 in. (5 m) or longer.

WIRING DIAGRAMS

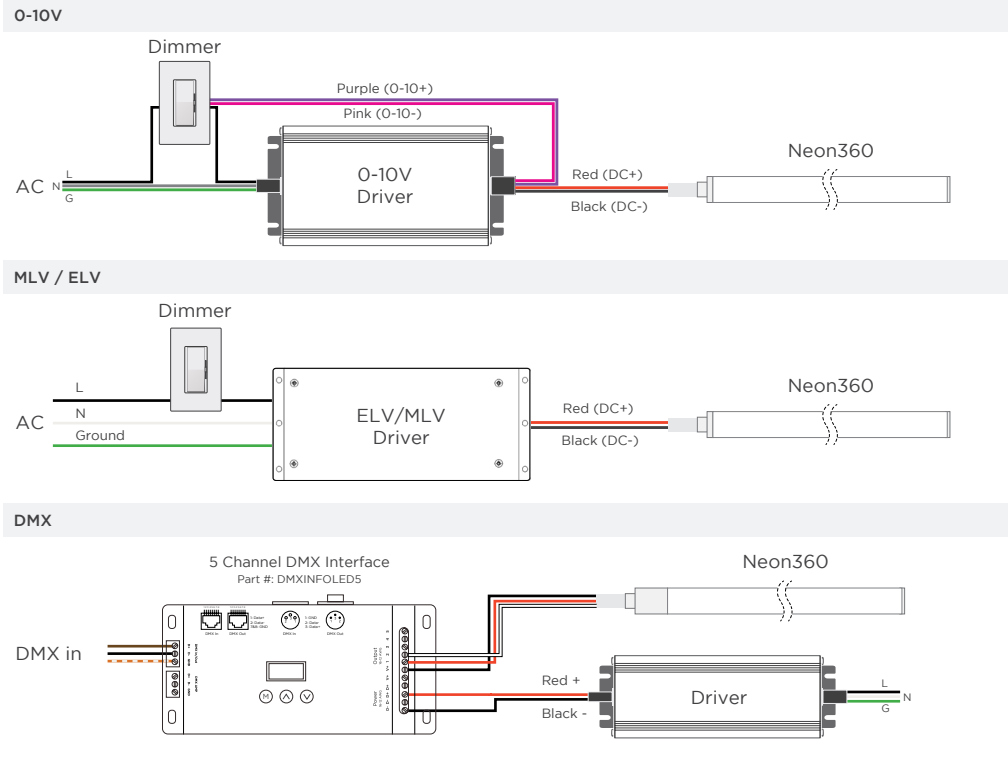

WIRE COLORS PER RIBBONLYTE COLOR

STATIC WHITE
Red Wire (+) Positive
Black Wire (-) Negative

USAGE GUIDELINES

- Neon360 cannot be cut in the field. All custom cuts and connections for these models must be performed at the factory to ensure waterproofing standards are met. Any modification of the waterproofing will result in a voided warranty.
- When installing this product take into account the surface temperature of the material this product is mounted to. Many building surfaces which are exposed to direct sunlight exceed the 60° C/140° F maximum that our product is rated for. High-risk locations like this should be avoided.
- This product is not intended to be submerged in pools and fountains and does not carry UL 676 certification to do so.
- Compatible with a wide variety of control products including the entire line of Lutron dimming systems.
- For use with Acolyte drivers, triac dimming modules, and 0-10 modules.
- Use with non-Acolyte drivers is not supported or warrantied
- Due to the cuttable points inside, this product's cuttable lengths are generally longer or shorter than the customer requested length. Unless specified, this product is factory cut at the shorter cuttable point
- This product can be used in wet, outdoor locations around swimming pools and spa tubs, but not submerged in swimming pools and spa tubs.
- We reserve the right to make changes to product lineup, specifications, design and finishes at any time without notice.

Acolyte does not warrant or represent that this information is free from errors or omission. The information may change without notice and Acolyte is not in any way liable for the accuracy of any information printed and stored or in any way interpreted or used.

REV.09JUL2024