



Date \_\_\_\_\_ Project \_\_\_\_\_

Notes \_\_\_\_\_

**NANO FLEX**

The Nano Flex is a flexible silicone grazer tube with three beam angle options. Available in five dimmable Static White CCTs (1800K-6500K), this IP68 grazer is compatible with 0-10V, ELV/MLV or DMX controls. Dual bending capabilities (side- and top-bending!) make this an amazing solution for complex grazer applications.

- 5.5 W/ft (18 W/m)
- 5 Static White CCTs (1800K, 2700K, 3000K, 4000K, 6500K)
- 0-10V, ELV/MLV or DMX controls
- 7 LEDs/ft (24 LEDs/m)
- 1.65 in. (42 mm) LED spacing
- 16 ft 4 in. (5 m) max. length (single feed)
- 3 in. (75 mm) min. side bending radius
- 3.5 in. (90 mm) min. top bending radius
- Beam angles: 15°x15°, 38°x38°, 60°x60°
- 80+ CRI with IP68 and IK08 ratings
- Available in white or black
- Use with mounting clips, mounting channel or curved mounting channel

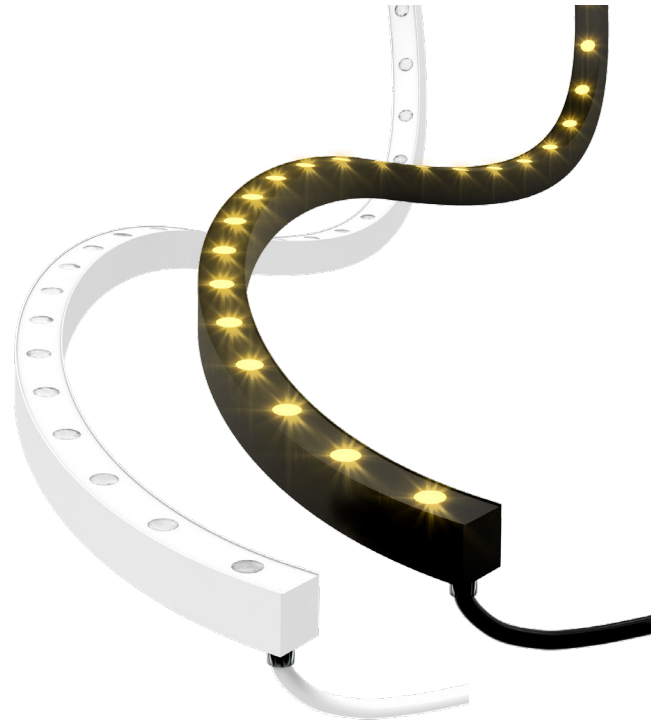

**ORDERING GUIDE**

Category	CRI	IP Rating	Wattage	Color Temperature	Beam Angles	Housing Color	Power Feed
NANOFLEX	80	68	5.5				
NANOFLEX - Nano Flex	80 - 80+ CRI	68 - IP68	5.5 - 5.5 W/ft (18 W/m)	18 - 1800K 27 - 2700K 30 - 3000K 40 - 4000K 65 - 6500K	15 - 15°x 15° 38 - 38°x 38° 60 - 60°x 60°	WH - White BK - Black	E - End Feed B - Bottom Feed

**ACCESSORIES:**

- M12 3-Pin Female to Bare Wire Input Cable  
M12CBLFB3PIN1000 (3 ft, 3.3 in. | 1 m)  
M12CBLFB3PIN2000 (6 ft, 6.7 in. | 2 m)  
M12CBLFB3PIN3000 (9 ft, 10 in. | 3 m)
- M12 3-PIN Male to Female Jumper Cable  
M12JUMPMF3PIN1000 (3 ft, 3.3 in. | 1 m)  
M12JUMPMF3PIN2000 (6 ft, 6.7 in. | 2 m)  
M12JUMPMF3PIN3000 (9 ft, 10 in. | 3 m)
- M12 3-PIN Power Cable, Double Feed (59 in. | 1.5 m)  
M12YCBLD3PIN1500
- M12 Male Connector - one side  
NANOFLEXMC1
- M12 Male Connector - both sides  
NANOFLEXMC2
- End Cap  
M12EC3PIN
- Mounting Clip  
NANOFLEXMC35
- Mounting Channel (length up to 3 ft, 3.3 in. | 1 m)  
CHNANOFLEXSSV
- Curved Mounting Channel (length up to 3 ft, 3.3 in. | 1 m)  
CHNANOFLEXC  
(for side-bending applications only)

**AVAILABLE COLOR TEMPERATURES**

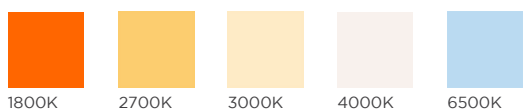

**AVAILABLE BEAM ANGLES**

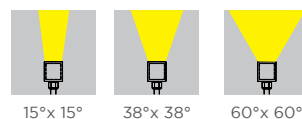

**SPECIFICATIONS**

Operating Voltage	24V DC
Power Consumption	5.5 W/ft (18 W/m)
Protection Rating	IP68
LED Quantity	7 LEDs/ft (24 LEDs/m)
LED Spacing	1.65 in. (42 mm)
Lumens	243.9 lm/ft (800 lm/m) for 38x38° model in 3000K
Beam Angle	15°x15°, 38°x38°, 60°x60°
Operating Temperature	14° F to 131° F (-10° C to 55° C)
Color Temperatures / Colors	1800K, 2700K, 3000K, 4000K, 6500K
Max Run Length	16 ft 4.85 in. (5 m) when power from one end / 32 ft 9.7 in. (10 m) when power from both ends
Cutable Length	10 in. (250 mm) <b>NOT FIELD CUTTABLE</b>
Minimum Bend Radius	3 in. (75 mm) min. side bending radius 3.5 in. (90 mm) min. top bending radius
CRI (white)	80+ for all Color Temperatures
Lumen Maintenance	L70 @ 25°C: 70,000 Hours, L70 @ 50°C: 50,000 Hours
Warranty	5 Years

**ACCESSORIES**

**M12 3-PIN POWER CABLE, DOUBLE FEED**

Part #:  
M12YCBLD3PIN1500 (59 in. | 15 m)

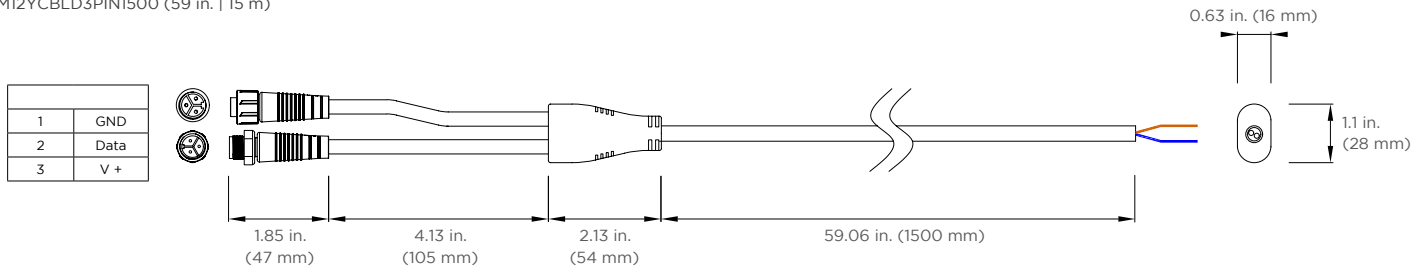

**M12 3-PIN MALE TO FEMALE JUMPER CABLE**

Part #:  
M12JUMPMF3PIN1000 (3 ft 3.3 in. | 1 m)  
M12JUMPMF3PIN2000 (6 ft 6.7 in. | 2 m)  
M12JUMPMF3PIN3000 (9 ft 10 in. | 3 m)

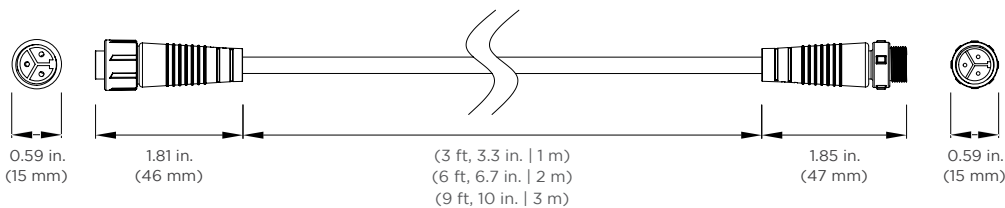

**END CAP**

Part #: M12EC3PIN

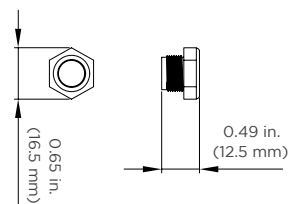

**USAGE GUIDELINES**

Nano Flex grazers cannot be cut in the field. All custom cuts and connections for these models must be performed at the factory to ensure waterproofing standards are met. Any modification of the waterproofing will result in a voided warranty.

Acolyte does not warrant or represent that the information is free from errors or omission. The information may change without notice and Acolyte is not in any way liable for the accuracy of any information printed and stored or in any way interpreted or used.

**DIMENSIONS**

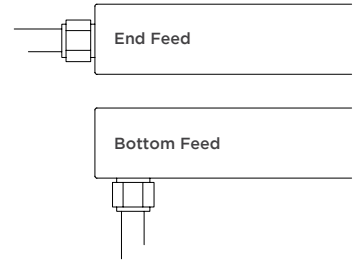
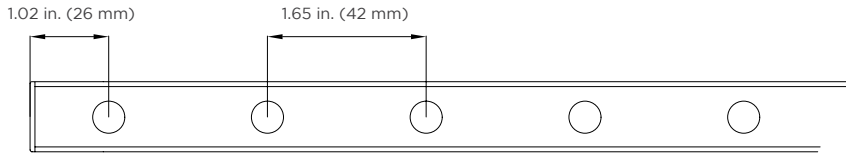

Nano Flex with Bare Wire (default option)

Nano Flex with Male Connector (additional accessory ordered separately)

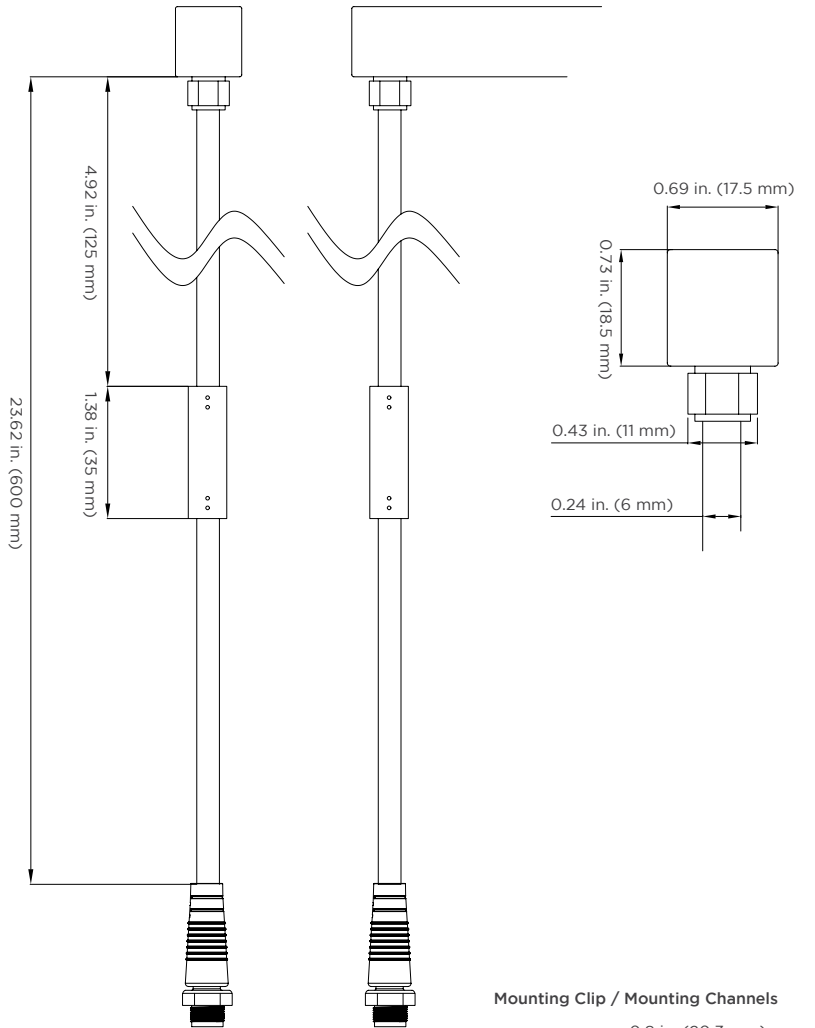
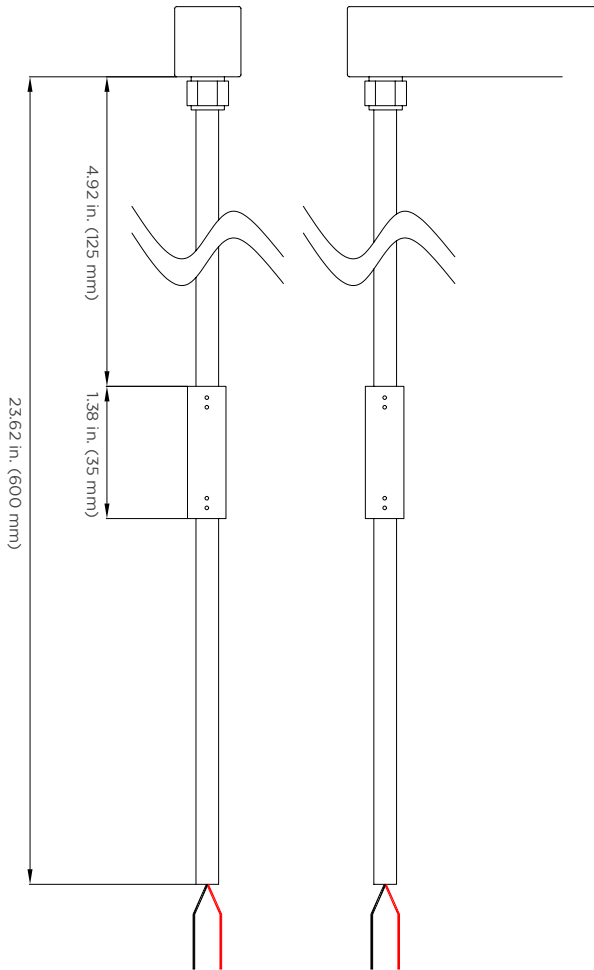

**Mounting Clip**  
Part #: NANOFLEXMC35



**Mounting Channel**  
Length up to 3 ft, 3.3 in. (1 m)  
Part #: CHNANOFLEXSSV



**Curved Mounting Channel**  
Length up to 3 ft, 3.3 in. (1 m)  
Part #: CHNANOFLEXC  
(for side-bending applications only)

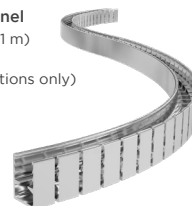

**Mounting Clip / Mounting Channels**

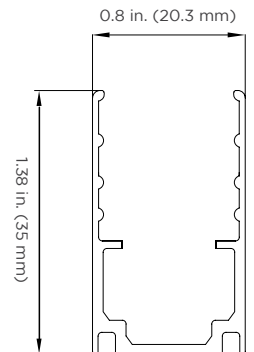

WIRING DIAGRAMS

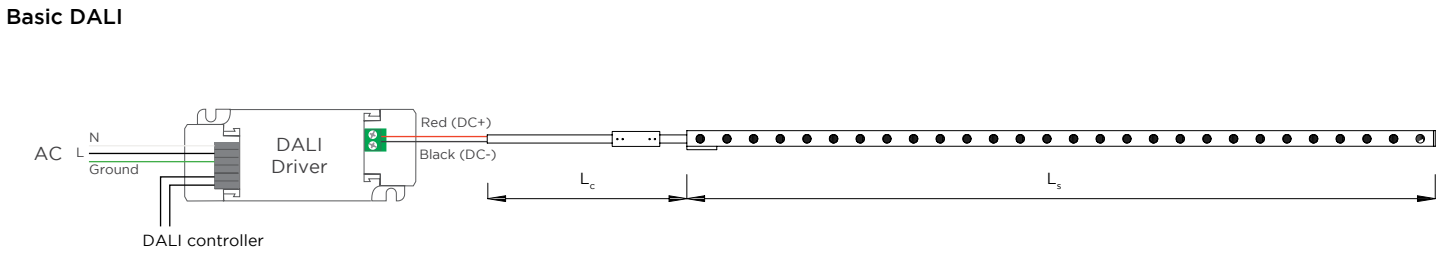
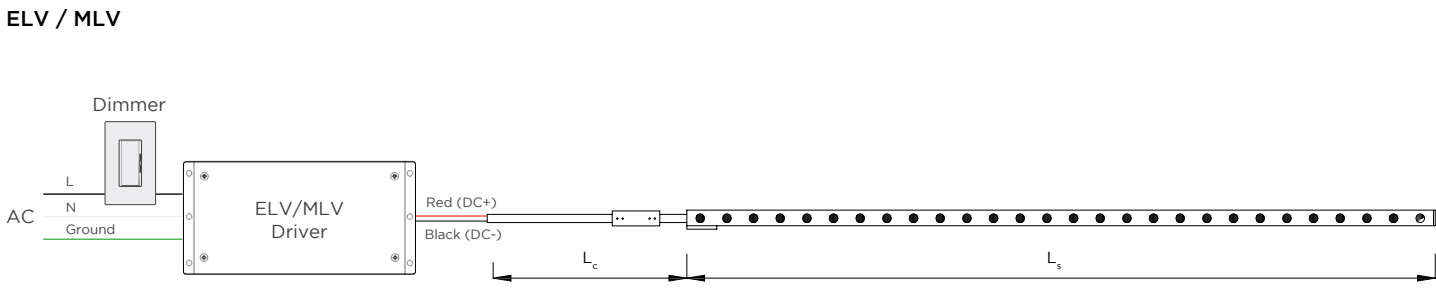
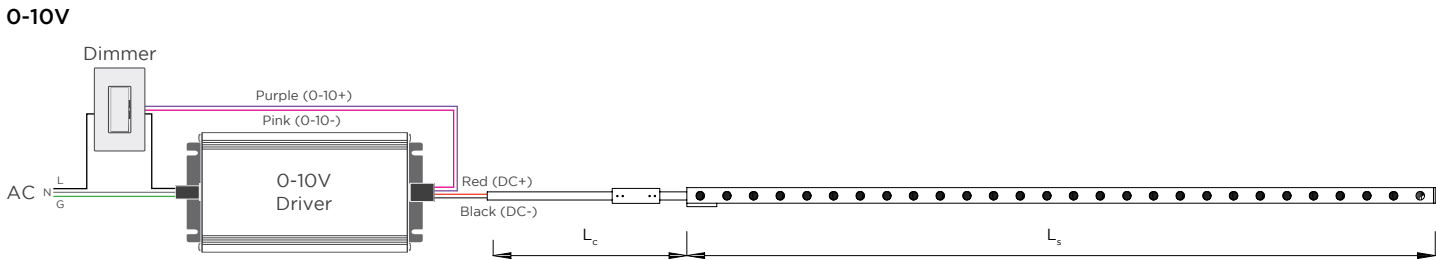
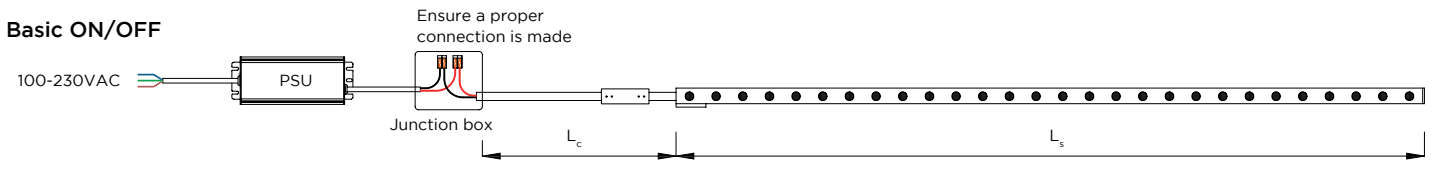

WIRING DIAGRAMS

**Basic Remote**

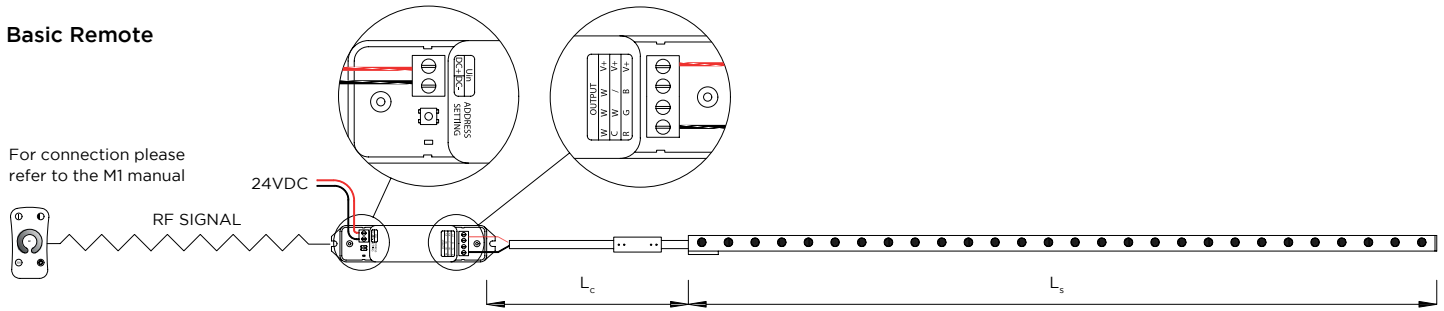

**Advanced**

