

AS5 CHANNEL FIXTURE

AS5 Channel is a low-profile aluminum channel. The 120-degree beam angle is ideal for a wide, even spread of light in cove and toe kick applications. Use AS5 in conjunction with our tiltable stands or with unique mounting clips that snap underneath, so you don't see the mounting clips or any fit lines on the outside of the channel. Custom design a fixture with our AS5 Channel and RibbonLyte products.

- Available for field assembly or factory assembly
- Beam Angle 120°
- Wattage Range from 0.75 W/ft (2.46 W/m) to 8.8 W/ft (28.9 W/m)
- Static White delivered lumen range from 44.1 lm/ft (144.6 lm/m) up to 673.2 lm/ft (2208.1 lm/m)
- Assembled in USA



HOUSING FINISHES



Silver Standard **Custom RAL***

*Additional fee applies

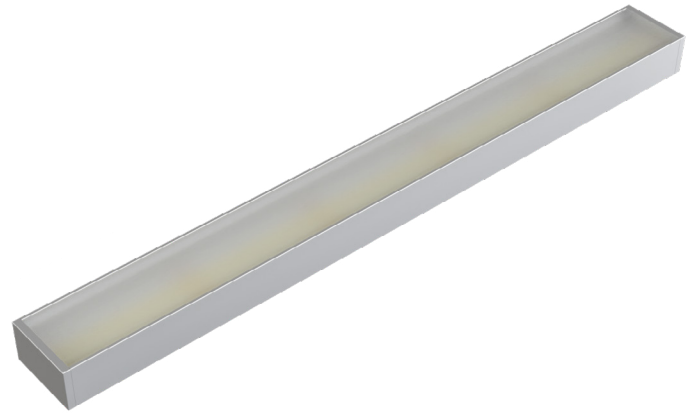

AVAILABLE LENS FINISHES



Frosted Lens
90% Light Transmission

AVAILABLE COLORS & COLOR TEMPERATURES



DIMENSIONS

AS5 Channel	Mounting Clip (included accessory)		
<p>Width: 0.76 in. (19.4 mm) Height: 0.43 in. (11 mm) Internal Width: 0.47 in. (12 mm)</p>	<p>Side View</p> <p>Width: 0.57 in. (14.5 mm) Length: 0.95 in. (24 mm) Height: 0.15 in. (3.7 mm)</p>	<p>Top View</p>	<p>Assembled View</p>
	<p>Note:</p> <ol style="list-style-type: none"> 1. Magnetic mounting option available (see page 2) 2. Exterior channel applications should be securely attached to the mounting surface with appropriate screws and/or liquid nails. Acolyte strongly recommends field assembly for exterior applications. Use mounting clips for interior applications only. 		

Acolyte does not warrant or represent that the information is free from errors or omission. The information may change without notice and Acolyte is not in any way liable for the accuracy of any information printed and stored or in any way interpreted or used.

SPECIFICATIONS

Beam Angle	120°
Lens Type	Frosted Lens
Length	Channel is sold by the foot and cut to your exact desired length. Required amount of mounting clips included.
Operating Voltage	24 V
Dimming	MLV / 0-10 Volt / ELV / DALI / DMX / CASAMBI
Operating Temperature	-40 – 158 °F (-40 – 70 °C)
Colors	1800K, 2000K, 2200K, 2400K, 2700K, 3000K, 3500K, 4000K, 6000K, Red, Amber, Green, Blue, RGBW, RGBWW, RGBA, VW, Warm Dim (1800K, 2000K, 2200K only available in IP20)
CRI	90+ CRI (for Static White LEDs only)
Lifetime (L70 reported)	50,000 hours
MacAdam ellipse (SDCM)	1-Step Binning (for Static White LEDs only)
Certifications	UL Listed UL 2108 Issued: 2004/02/27 Ed: 1 Rev: 2014/02/24 Low Voltage Lighting Systems CSA C22.2#9.0 Issued: 1996/06/01 Ed: 1 (R2011) General Requirements for Luminaries; with Gen. Inst. 1: 1997, Gen Inst. 2: 1998. ROHS compliant

ACCESSORIES

Tilttable Stand (Part # TILTSTANDST)

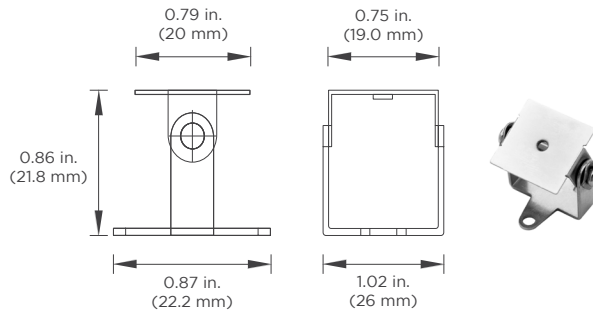

Assembled Height with Channel: 1.29 in. (32.8 mm)

Magnetic Mount (Part #: CHMAGO.5)

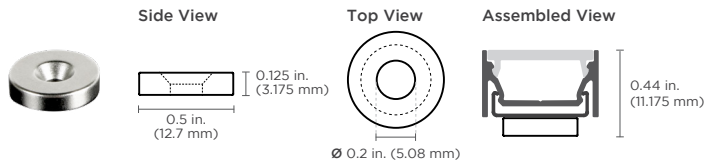

Features:

- High-energy neodymium magnets come attached to mounting clips with countersink hex nuts
- Create easy-mount magnetic channels with minimal surface gaps; no tools or drilling necessary
- Magnets rated for 8 lbs. of pull force with static load

Applications:

- Industrial lighting retrofits for troffers and other metal fixtures
- Metal retail shelf lighting
- Temporary light fixture installations

ORDERING GUIDE

STEP 1 Complete Channel Part Number

CHANNEL	LENS	HOUSING COLOR
CHAS5	F	SV
CHAS5 - AS5 Channel	F - Frosted Lens	SV - Silver (default) Consult factory for custom colors (additional fee applies)

STEP 2 Complete RibbonLyte Part Number

CATEGORY	CRI	RIBBON TYPE & IP RATING		
RB				
RB - RibbonLyte	0 - Static Color, Color Changing	LINEA20 - Linea RibbonLyte IP20	RGBWW20 - RGBWW 5-in-1 IP20	WD20 - Warm Dim IP20
	90 - 90+ CRI Static White	SWS220 - Static White Series 2 IP20	RGBWS220 - RGBW Series 2 IP20	WD65 - Warm Dim IP65
		SWS265 - Static White Series 2 IP65	RGBWS265 - RGBW Series 2 IP65	XACTA20 - Xacta RibbonLyte IP20
		SCS220 - Static Color Series 2 IP20	VWS220 - VW Series 2 IP20	RGBADD - Pixel RGB IP20
		SCS265 - Static Color Series 2 IP65	VWS265 - VW Series 2 IP65	

NOTE: To ensure waterproofing standards are met, IP65 RibbonLyte can NOT be cut in the field.

WATTAGE	COLOR
0.75 - 0.75 W/ft (2.46 W/m - Static White, Static Color)	18 - 1800K
1.0 - 1.0 W/ft (3.3 W/m - Variable White)	20 - 2000K
1.5 - 1.5 W/ft (4.9 W/m - Static White, Static Color)	22 - 2200K
2.2 - 2.2 W/ft (7.2 W/m - Static White, Static Color)	24 - 2400K
2.4 - 2.4 W/ft (8 W/m - Static White Linea)	27 - 2700K
3.0 - 3.0 W/ft (9.8 W/m - Static White, Static Color, Variable White)	30 - 3000K
4.3 - 4.3 W/ft (14 W/m - Static White Linea)	35 - 3500K
4.4 - 4.4 W/ft (14.4 W/m - Static White, Static Color, RGBW, RGBWW, RGBA)	40 - 4000K
4.5 - 4.5 W/ft (14.8 W/m - Static White, Variable White)	60 - 6000K
5.0 - 5.0 W/ft (16.4 W/m - Static White, Static Color)	R - Red
5.2 - 5.2 W/ft (17.1 W/m - Warm Dim)	A - Amber
5.3 - 5.3 W/ft (17.5 W/m - Pixel RGB)	G - Green
5.5 - 5.5 W/ft (18.0 W/m - RGBW, RGBA)	B - Blue
6.0 - 6.0 W/ft (19.7 W/m - Static White, Static Color, Variable White)	
6.1 - 6.1 W/ft (20 W/m - Variable White Linea)	
8.8 - 8.8 W/ft (28.9 W/m - RGBW, RGBWW)	

CONNECTION OPTIONS (See diagrams on the right)	Custom Length (ft.)
1 - End Feed Bare Wire Connection	
2 - Back Feed Bare Wire Connection	
3 - Side Feed Bare Wire Connection	
4 - End Feed with IP67 Male Coupler	
5 - Soldered Daisy Chain	
6 - Daisy Chain With IP67 Couplers	

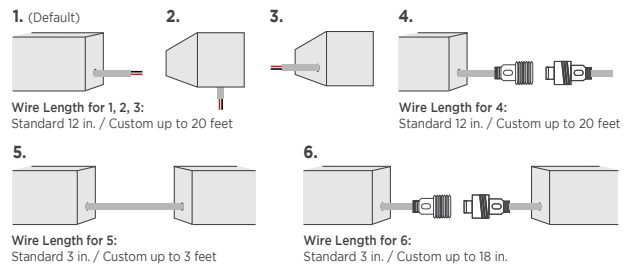

STEP 3 Complete Assembly Option & Length

ASSEMBLY OPTION	LENGTH (Standard factory assembled length up to 6 ft 6.7 in. / 2 m)
FI - Field Assembly	
FA - Factory Assembly* (not recommended for exterior applications)	

* Factory assembled runs exceeding 6 ft 6.7 in. (2 m) will be split into multiple daisy chained fixtures.

STEP 4 Add Accessories

ACCESSORIES	
TILTSTANDST - Tiltable Stand	CHMAGO.5 - Magnetic Mount

DO NOT BUTT END CAPS AGAINST EACH OTHER WHEN CREATING LONGER FIXTURES
Acolyte STRONGLY SUGGESTS field assembly (without using interior end caps) for direct-view fixtures of more than 6 ft 6.7 in. (2 m) in length. Field assembly without interior end caps will eliminate gaps or dead spots that can be caused by butting interior end caps against each other.

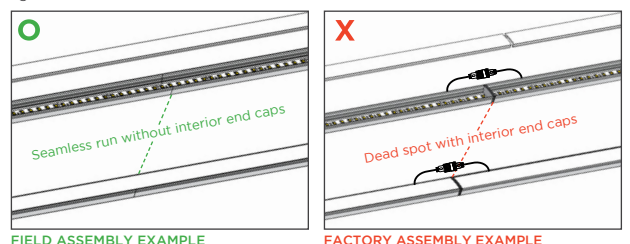

RIBBONLYTE SPECIFICATIONS & COMPATIBILITY

Available Wattages	Cuttable Length	LED Pitch	Color Temp.	lm/W without Lens	Delivered Lumens with Frosted Lens		Max Length	Compatible with Channel		
					lm/ft	lm/m		IP20	IP65	IP68
0.75 Static White Series 2	1.97 in. (50 mm)	48 LEDs/ft (160 LEDs/m)	1800K	84	53.6	175.8	IP20: 49 ft (15 m) IP65: 32.8 ft (10 m)	✓	✓	
			2000K	99	63.1	207				
			2200K	109	69.5	228				
			2400K	113	72	236.2				
			2700K	123	78.4	257.2				
			3000K	123	78.4	257.2				
			3500K	130	82.9	272				
			4000K	134	85.4	280.1				
1.5 Static White Series 2	1.97 in. (50 mm)	48 LEDs/ft (160 LEDs/m)	1800K	84	107.1	351.3	IP20: 49 ft (15 m) IP65: 32.8 ft (10 m)	✓	✓	
			2000K	98	125	410				
			2200K	109	139	455.9				
			2400K	113	144.1	472.6				
			2700K	123	156.8	514.3				
			3000K	123	156.8	514.3				
			3500K	129	164.5	539.6				
			4000K	134	170.9	560.6				
2.2 Static White Series 2	1.97 in. (50 mm)	48 LEDs/ft (160 LEDs/m)	1800K	83	155.2	509.1	IP20: 42 ft (12.8 m) IP65: 32.8 ft (10 m)	✓	✓	
			2000K	96	179.5	588.8				
			2200K	106	198.2	650.1				
			2400K	111	207.6	680.9				
			2700K	120	224.4	736				
			3000K	122	228.1	748.2				
			3500K	127	237.5	779				
			4000K	133	248.7	779				
3.0 Static White Series 2	1.97 in. (50 mm)	48 LEDs/ft (160 LEDs/m)	1800K	84	226.8	743.9	IP20: 36 ft (11 m) IP65: 32.8 ft (10 m)	✓	✓	
			2000K	98	264.6	867.9				
			2200K	108	291.6	956.4				
			2400K	109.8	280.1	918.6				
			2700K	122.9	313.5	1028.1				
			3000K	130	331.4	1087.1				
			3500K	133	339.2	1112.4				
			4000K	133	339.2	1112.4				
4.4 Static White Series 2	1.97 in. (50 mm)	48 LEDs/ft (160 LEDs/m)	1800K	81	320.8	1052.1	28 ft 4 in. (8.64 m)	✓	✓	
			2000K	95	376.2	1233.9				
			2200K	105	415.8	1363.8				
			2400K	109	407.7	1337.1				
			2700K	124	456.3	1496.6				
			3000K	131	482.5	1582.5				
			3500K	133	493.7	1619.3				
			4000K	133	493.7	1619.3				
5.0 Static White Series 2	1.4 in. (35.7 mm)	68 LEDs/ft (224 LEDs/m)	1800K	83	373.5	1225.1	IP20: 33 ft 4 in. (10.1 m) IP65: 32.8 ft (10 m)	✓	✓	
			2000K	98	441.0	1446.5				
			2200K	107	481.5	1579.3				
			2400K	110	466.8	1531				
			2700K	124	522.4	1713.6				
			3000K	134	552.4	1811.9				
			3500K	135	565.3	1854				
			4000K	134	565.3	1854				
6.0 Static White Series 2	1.4 in. (35.7 mm)	68 LEDs/ft (224 LEDs/m)	1800K	82	442.8	1452.4	28 ft (8.5 m)	✓	✓	
			2000K	95	513.0	1682.6				
			2200K	106	572.4	1877.5				
			2400K	109	555.9	1823.4				
			2700K	122	622.2	2040.8				
			3000K	129	657.9	2157.9				
			3500K	132	673.2	2208.1				
			4000K	132	673.2	2208.1				
6.0 Static White Series 2	1.4 in. (35.7 mm)	68 LEDs/ft (224 LEDs/m)	1800K	126	642.6	2107.7				
			2000K							
			2200K							
			2400K							
			2700K							
			3000K							
			3500K							
			4000K							

RIBBONLYTE SPECIFICATIONS & COMPATIBILITY

Available Wattages	Cuttable Length	LED Pitch	Color Temp.	lm/W without Lens	Delivered Lumens with Frosted Lens		Max Length	Compatible with Channel		
					lm/ft	lm/m		IP20	IP65	IP68
0.75 Static Color Series 2	1.97 in. (50 mm)	48 LEDs/ft (160 LEDs/m)	Red	41	26	86	IP20: 49 ft (15 m) IP65: 32.8 ft (10 m)	✓	✓	
			Green	175	112	366				
			Blue	19	12	40				
			Amber	34	22	71				
1.5 Static Color Series 2	1.97 in. (50 mm)	48 LEDs/ft (160 LEDs/m)	Red	42	54	176	IP20: 49 ft (15 m) IP65: 32.8 ft (10 m)	✓	✓	
			Green	160	204	669				
			Blue	18	23	75				
			Amber	33	43	142				
2.2 Static Color Series 2	1.97 in. (50 mm)	48 LEDs/ft (160 LEDs/m)	Red	42	79	258	IP20: 42 ft (12.8 m) IP65: 32.8 ft (10 m)	✓	✓	
			Green	145	271	889				
			Blue	18	34	110				
			Amber	33	62	202				
3.0 Static Color Series 2	1.97 in. (50 mm)	48 LEDs/ft (160 LEDs/m)	Red	40	102	334.6	32.8 ft (10 m)	✓	✓	
			Green	127	323.9	1062.2				
			Blue	25	63.8	209.1				
			Amber	29	74	242.6				
4.4 Static Color Series 2	1.97 in. (50 mm)	48 LEDs/ft (160 LEDs/m)	Red	38	142.1	466.2	29 ft (8.8 m)	✓	✓	
			Green	117	437.6	1435.3				
			Blue	24	89.8	294.4				
			Amber	25	93.5	306.7				
5.0 Static Color Series 2	1.4 in. (35.7 mm)	68 LEDs/ft (224 LEDs/m)	Red	37	157.3	515.8	30 ft (9.14 m)	✓	✓	
			Green	116	493	1617				
			Blue	24	102	334.6				
			Amber	26	110.5	362.4				
6.0 Static Color Series 2	1.4 in. (35.7 mm)	68 LEDs/ft (224 LEDs/m)	Red	37	188.7	618.9	28 ft (8.5 m)	✓	✓	
			Green	113	576.3	1890.3				
			Blue	23	117.3	384.8				
			Amber	24	122.4	401.6				
2.4 Static White Linea	1.97 in. (50 mm)	146 LEDs/ft (480 LEDs/m)	2700K	67	136.9	448.8	21.3 ft (6.5 m)	✓	n/a	n/a
			3000K	71	144.5	475.2				
			3500K	83	169.2	555.9				
			4000K	83	169.2	555.9				
3.0 Static White Linea	1.97 in. (50 mm)	146 LEDs/ft (480 LEDs/m)	2700K	66	168.3	552.5	21.3 ft (6.5 m)	✓	n/a	n/a
			3000K	73	186.2	611.2				
			3500K	78	198.9	652.8				
			4000K	83	211.7	694.5				
4.3 Static White Linea	1.97 in. (50 mm)	146 LEDs/ft (480 LEDs/m)	2700K	75	274.6	899.3	24.6 ft (7.5 m)	✓	n/a	n/a
			3000K	78	284.8	935				
			3500K	86	314.5	1031.9				
			4000K	86	314.5	1031.9				
6.1 Variable White Linea	1.09 in. (27.78 mm)	175 LEDs/ft (576 LEDs/m)	2700K + 6500K	95	493	1617.6	16.4 ft (5 m)	✓	n/a	n/a

RIBBONLYTE SPECIFICATIONS & COMPATIBILITY

Available Wattages	Cuttable Length	LED Pitch	Color Temp.	lm/W without Lens	Delivered Lumens with Frosted Lens		Max Length	Compatible with Channel		
					lm/ft	lm/m		IP20	IP65	IP68
1.5 Static White Xacta	0.2 in. (5 mm)	61 LEDs/ft (200 LEDs/m)	1800K	71	101.8	334.1	32.74 ft (9.98 m)	✓	n/a	n/a
			2000K	84	120.2	394.3				
			2200K	92	131.9	432.6				
			2400K	96	136.9	449.1				
			2700K	109	155.3	509.3				
			3000K	113	161.9	531.2				
			3500K	117	166.9	547.7				
			4000K	115	163.6	536.7				
			6000K	112	160.3	525.7				
3.0 Static White Xacta	0.2 in. (5 mm)	61 LEDs/ft (200 LEDs/m)	1800K	71	181.3	594.9	23.62 ft (7.2 m)	✓	n/a	n/a
			2000K	84	214	702.2				
			2200K	92	234.8	770.5				
			2400K	95	243.7	799.7				
			2700K	108	276.4	907				
			3000K	113	288.3	946				
			3500K	116	297.2	975.3				
			4000K	114	291.3	955.8				
			6000K	111	285.4	936.3				
4.5 Static White Xacta	0.2 in. (5 mm)	61 LEDs/ft (200 LEDs/m)	1800K	72	276.8	908.2	19.03 ft (5.8 m)	✓	n/a	n/a
			2000K	85	326.7	1072				
			2200K	93	358.5	1176.2				
			2400K	97	372.1	1220.9				
			2700K	110	422	1384.6				
			3000K	114	440.2	1444.2				
			3500K	118	453.8	1488.9				
			4000K	116	444.7	1459.1				
			6000K	113	435.7	1429.3				
1.5 Variable White Xacta	0.2 in. (5 mm)	122 LEDs/ft (400 LEDs/m)	2400K + 6000K	138	174.7	573.2	32.15 ft (9.8 m)	✓	n/a	n/a
3.0 Variable White Xacta	0.2 in. (5 mm)	122 LEDs/ft (400 LEDs/m)	2400K + 6000K	136	342.9	1125.1	22.31 ft (6.8 m)	✓	n/a	n/a
4.5 Variable White Xacta	0.2 in. (5 mm)	122 LEDs/ft (400 LEDs/m)	2400K + 6000K	134	484.3	1588.9	19.03 ft (5.8 m)	✓	n/a	n/a
1.0 Variable White Series 2	1.97 in. (50 mm)	42 LEDs/ft (140 LEDs/m)	2000K + 6500K	85	72.3	237	32.8 ft (10 m)	✓	✓	✓
3.0 Variable White Series 2	1.97 in. (50 mm)	42 LEDs/ft (140 LEDs/m)	2000K + 6500K	80	205	670	32.8 ft (10 m)	✓	✓	✓
6.0 Variable White Series 2	1.97 in. (50 mm)	42 LEDs/ft (140 LEDs/m)	2000K + 6500K	75	382.5	1255	19 ft 8 in. (6 m)	✓	✓	✓
4.4 RGBW Series 2	1.97 in. (50 mm)	36 LEDs/ft (120 LEDs/m)	RGBW (all on)	45	168.3	552.2	19 ft 8 in. (6 m)	✓	n/a	n/a
5.5 RGBW Series 2	1.97 in. (50 mm)	36 LEDs/ft (120 LEDs/m)	RGBW (all on)	59	275.8	904.9	IP65: 16 ft 4 in. (5 m) IP68: 19 ft 7.9 in. (6 m)	N/A	✓	
8.8 RGBW Series 2	1.97 in. (50 mm)	36 LEDs/ft (120 LEDs/m)	RGBW (all on)	61	456.3	1497.1	16 ft 4 in. (5 m)	✓	n/a	n/a
5-in-1 RGBWW	2.46 in. (62.5 mm)	29 LED/ft (96 LED/m)	RGBWW (all on)	59	220.7	724	16 ft 4 in. (5 m)	✓	n/a	n/a
8.8 5-in-1 RGBWW	2.46 in. (62.5 mm)	29 LED/ft (96 LED/m)	RGBWW (all on)	50	374	1227.1	11 ft 6 in. (3.5 m)	✓	n/a	n/a
5.3 Pixel RGB	3.94 in. (100 mm)	18 LEDs/ft (60 LEDs/m)	RGB (All on)	21	105.83	346.8	24 ft 7.2 in. (7.5 m)	✓	n/a	n/a
5.2 Warm Dim	3.94 in. (100 mm)	36 LEDs/ft (120 LEDs/m)	WARM DIM	55	244.8	803.25	16 ft 4 in. (5 m)	✓	✓	

DIODE VISIBILITY CHART

No Visible Diode = N					With Visible Diode = Y					
Note: Linea RibbonLyte has no visible diode										
Static White & Static Color Series 2		Static White & Static Color Xacta		RGBW & RGBA Series 2		5-in-1 RGBWW	5-in-1 RGBWW	Pixel RGB	Variable White Series 2	Warm Dim
0.75/1.5/2.2/3.0	4.4/5.0/6.0	1.5/3.0/4.5		4.4/8.8	5.5	4.4	8.8	5.3	1.0/3.0/6.0	5.2
IP20 / IP65	IP20 / IP65	IP20		IP20	IP65	IP20	IP20	IP20	IP20 / IP65	IP20 / IP65
Y	Y	Y		Y	Y	Y	Y	Y	Y	Y

AVAILABLE DRIVERS / CONTROLLERS AND DIMMING OPTIONS / WIRE GAUGE CHART

0-10V/ELV/MLV 3-IN-1	ELV	0-10V VW/WD	COMPACT
<p>60W, 96W, 288W 0-10V/ELV/MLV 3-in-1 Dimmable Drivers</p> <p>Part No.:</p> <ul style="list-style-type: none"> • DRVW2460TRI010 (60 W) • DRVW2496TRI010 (96 W) • DRVW24288TRI010 (288 W) <p>24 VDC 120-277 VAC IP65, dry/damp/wet locations UL Listed</p>	<p>60W Dimmable Driver</p> <p>Part No.:</p> <ul style="list-style-type: none"> • DRVW2460ELV <p>24 VDC 100-130 VAC Fits in single-gang switch boxes IP20, dry locations UL Recognized</p>	<p>0-10V Dimmable 90W VW/WD Driver</p> <p>Part No.:</p> <ul style="list-style-type: none"> • DRVRFWDVW2490120 <p>24 VDC 100-277 VAC IP23, dry/damp locations UL Listed</p>	<p>60W, 96W Non-Dimming Compact Drivers</p> <p>Part No.:</p> <ul style="list-style-type: none"> • DRV2460C (60 W) • DRV2496C (96 W) <p>24 VDC 120-277 VAC IP20, dry locations UL Class P</p>

ATHENA WIRELESS COMPATIBLE	CASAMBI COMPATIBLE DRIVERS	DIMMABLE DALI-2 DRIVERS	DIMMABLE DALI-2 DRIVERS
<p>94W Athena Wireless Compatible Drivers</p> <p>Part No.:</p> <ul style="list-style-type: none"> • DRVW2494ATH1CH (1 channel) • DRVW2494ATH2CH (2 channel) <p>24 VDC 100-277 VAC Dry locations UL Listed</p>	<p>100W & 200W Casambi Compatible 4 Channel Drivers</p> <p>Part No.:</p> <ul style="list-style-type: none"> • DRVW24100CAS4CH (100 W) • DRVW24200CAS4CH (200 W) <p>24 VDC 100-277 VAC IP66, dry/damp/wet locations UL Listed, CE, RoHS, Bluetooth, CASAMBI</p>	<p>96W DIMMABLE DALI-2 DT6 D4I & DALI-2 DT8 D4I DRIVERS</p> <p>Part No.:</p> <ul style="list-style-type: none"> • DRVW2496DALI1CH (1 channel) • DRVW2496DALI2CH (2 channel) <p>24-26 VDC 120-277 VAC IP67, dry/damp/wet locations UL Listed</p>	<p>75W, 150W, 240W DALI-2 Dimmable Drivers</p> <p>Part No.:</p> <ul style="list-style-type: none"> • DRVW2475DALI1CH (75 W, 1 channel) • DRVW24150DALI1CH (150 W, 1 channel) • DRVW24240DALI1CH (240 W, 1 channel) • DRV24150DALI2CH (150 W, 2 channels) • DRV24150DALI4CH (150 W, 4 channels) <p>24 VDC 120-277 VAC IP67, damp/wet locations (1-channel drivers only) IP20, dry location (2-channel & 4-channel drivers only) CE, RoHS, SELV</p>

DMX CONTROLLERS, VARIABLE WHITE DIMMER, WARM DIM DIMMER - FOR COLOR CHANGING FIXTURES

<p>GLASS TOUCH WALL CONTROLLERS</p> <p>Part No.:</p> <ul style="list-style-type: none"> • AWCRGBWBK • AWCVWBK 	<p>1 ZONE WALL CONTROLLER</p> <p>Part No.: DMXCTRLG</p>	<p>5 ZONE WALL CONTROLLER</p> <p>Part No.: DMXCTRL</p>	<p>10 ZONE WALL CONTROLLER</p> <p>Part No.: DMXCTRLD</p>	<p>6 UNIVERSE DMX CONTROLLER</p> <p>Part No.: DMXCTRLDR6U</p>
<p>VARIABLE WHITE DIMMER</p> <p>Part No.:</p> <ul style="list-style-type: none"> • RFDIMVWWH (White) • RFDIMVWBK (Black) 	<p>WARM DIM DIMMER</p> <p>Part No.:</p> <ul style="list-style-type: none"> • RFDIMWDWH (White) • RFDIMWDBK (Black) 	<p>4 CHANNEL WATERPROOF DMX INTERFACE</p> <p>Part No.: DMXINFWLCD4</p>	<p>5 CHANNEL DMX DECODER</p> <p>Part No.: DMXINF5</p>	<p>DMX OPTO SPLITTER</p> <p>Part No.: DMXOS8</p>

Wattages	30		60		96		150		200		240		300		320	
	Feet	Meters	Feet	Meters	Feet	Meters	Feet	Meters	Feet	Meters	Feet	Meters	Feet	Meters	Feet	Meters
24 AWG / 0.25 mm ²	14	4.27	9	2.74	5.5	1.68	3.75	1.14	2.75	0.84	2.25	0.69	1.75	0.53	1.75	0.53
22 AWG / 0.34 mm ²	22	6.71	14	4.27	9	2.74	5.75	1.75	4.5	1.37	3.5	1.07	2.75	0.84	2.75	0.84
20 AWG / 0.5 mm ²	35	10.67	23	7.01	14	4.27	9	2.74	7	2.13	5.75	1.75	4.5	1.37	4.25	1.30
18 AWG / 0.75 mm ²	56	17.07	37	11.28	23	7.01	15	4.57	11	3.35	9	2.74	7.5	2.29	7	2.13
16 AWG / 1.5 mm ²	90	27.44	60	18.29	37	11.28	24	7.32	18	5.49	15	4.57	12	3.66	11	3.35
14 AWG / 2.5 mm ²	142	43.29	95	28.96	59	17.99	38	11.59	28	8.54	23	7.01	19	5.79	17	5.18
12 AWG / 4 mm ²	226	68.90	151	46.04	94	28.66	60	18.29	45	13.72	37	11.28	30	9.15	28	8.54
10 AWG / 6 mm ²	360	109.76	240	73.17	150	45.73	96	29.27	72	21.95	60	18.29	48	14.63	45	13.72
8 AWG / 10 mm ²	574	175.00	381	116.16	239	72.87	153	46.65	115	35.06	95	28.96	76	23.17	71	21.65

WIRING DIAGRAMS - STATIC WHITE / STATIC COLOR / RGBW / RGBA / RGBWW

0-10 V

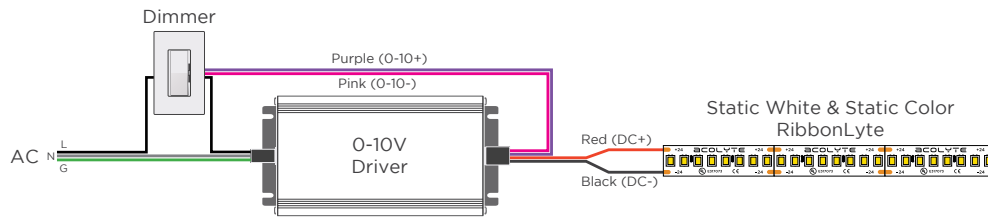

MLV / ELV

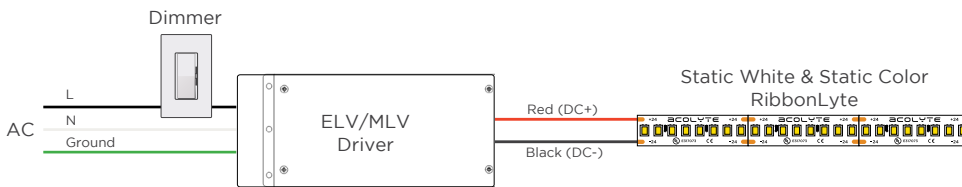

DMX WIRING WITH STATIC WHITE & STATIC COLOR RIBBONLYTE

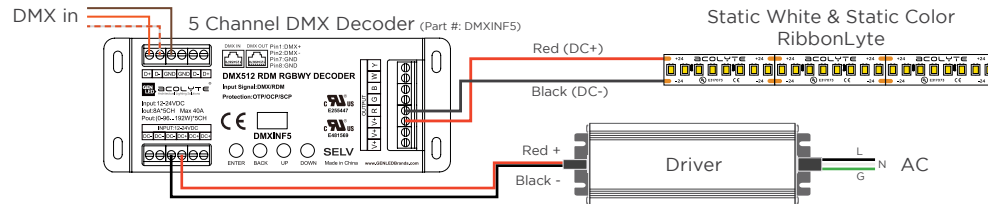

DALI-2 WIRING WITH STATIC WHITE & STATIC COLOR RIBBONLYTE

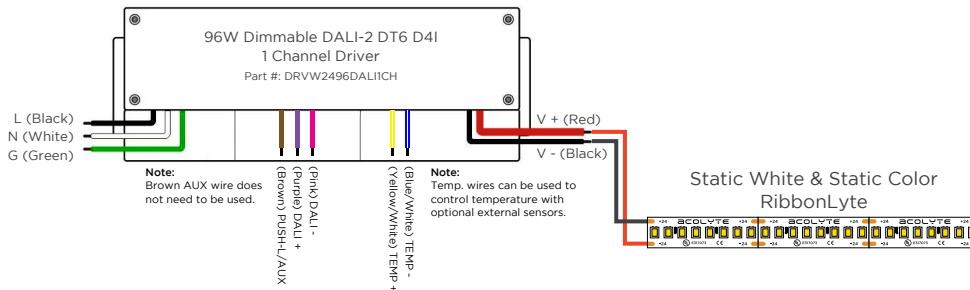

STATIC WHITE & STATIC COLOR RIBBONLYTE WIRING WITH ATHENA WIRELESS COMPATIBLE DRIVER

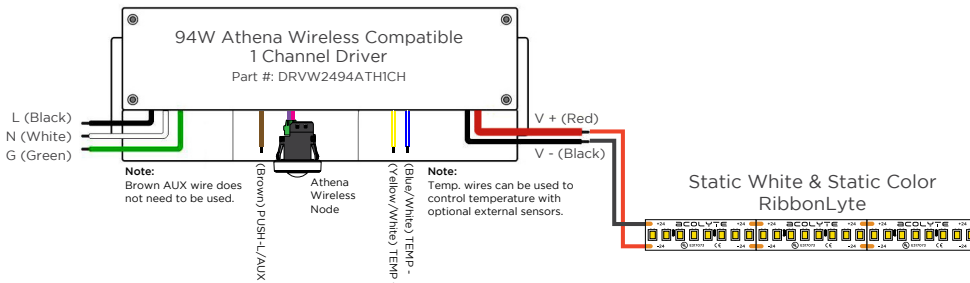

DMX WITH RGBWW 5-IN-1 RIBBONLYTE

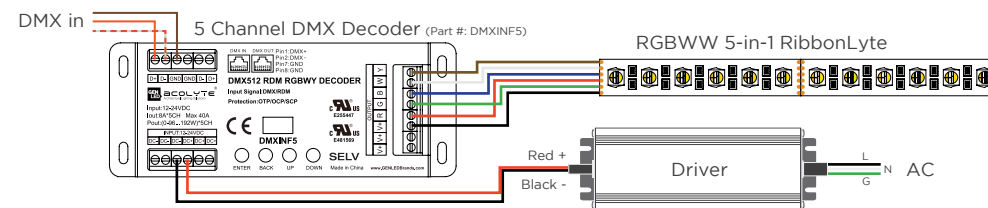

WIRE COLORS PER RIBBONLYTE COLOR

STATIC WHITE + STATIC COLOR

Red Wire (+) Positive
Black Wire (-) Negative

RGBW + RGBA

Black Wire (+) Positive
Green Wire (-) goes to Green Channel
Red Wire (-) goes to Red Channel
Blue Wire (-) goes to Blue Channel
White Wire (-) goes to White Channel

RGBWW

Black (+) Positive
Green Wire (-) goes to Green Channel
Red Wire (-) goes to Red Channel
Blue Wire (-) goes to Blue Channel
White Wire (-) goes to White Channel 1
Brown Wire (-) goes to White Channel 2

WIRING DIAGRAMS - VARIABLE WHITE

2-CHANNEL VARIABLE WHITE DIMMING

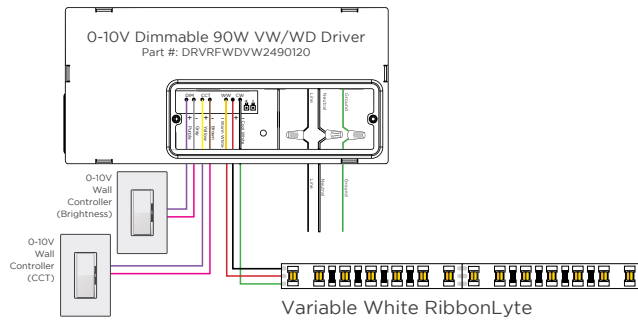

WIRE COLORS PER RIBBONLYTE COLOR

VARIABLE WHITE
Black Wire (+) Positive
Red Wire (-) goes to Warm White Channel
Green Wire (-) goes to Cool White Channel

DMX WIRING WITH VARIABLE WHITE RIBBONLYTE

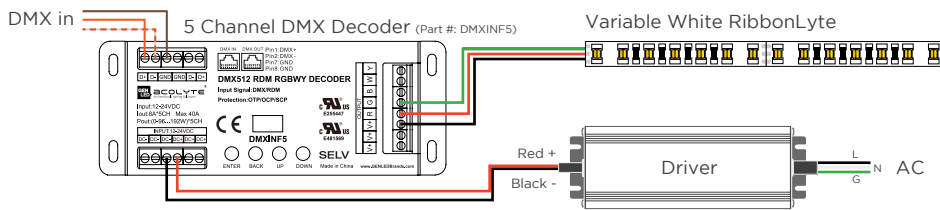

DALI-2 WIRING WITH VARIABLE WHITE RIBBONLYTE

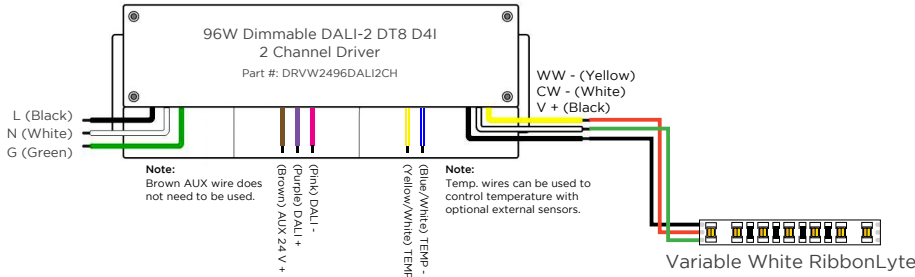

VARIABLE WHITE RIBBONLYTE WIRING WITH ATHENA WIRELESS COMPATIBLE DRIVER

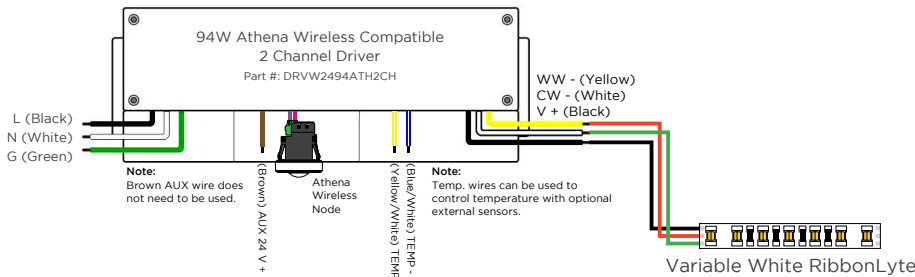

REV.24JUN2026

GLOBAL HQ

320 Murray Hill Pkwy
East Rutherford, NJ 07073
U.S.
T: (+1) 212 629 6830
E: Sales-US@GENLEDBrands.com

EUROPEAN HQ

Hogeweyselaan 119
1382 JK Weesp
Netherlands
T: (+31) 346 235 000
E: SalesEurope@GENLEDBrands.com

MEINA HQ

PO Box 371378, #823, Building 4EA
Dubai Airport Free Zone
Dubai, UAE
T: (+971) 4 701 7901
E: SalesMEINA@genlebrands.com

ASIA-PACIFIC HQ

Room 402, Building D
Shenshi Tongchuang Science and Technology Park
No. 16 Hongyin Road
Xingqiang Community, Xinhui Street
Guangming District, Shenzhen, China 518107
T: (+86) 755 8529 0710
E: Sales-Pacific@GENLEDBrands.com