

### 200W CASAMBI COMPATIBLE 4 CHANNEL DRIVER

The 200W Casambi Compatible 4 Channel Driver uses a Casambi/Bluetooth protocol with chip technology that enables long-range communications (up to 50 m/165 ft) in integrated drivers, fixtures and sensors for advanced wireless control systems. It is designed to simplify management of smart lighting features such as dimming, color selection and sensor detection. Use with the Casambi app or Casambi-compatible controls. With input voltage ranging from 100-277 VAC, this highly efficient 24 VDC output driver helps extend LED lifetimes in commercial, industrial and residential applications.



- Long-range wireless communications (up to 50 m/165 ft)
- Works with Casambi app or Casambi-compatible controls
- Casambi technology utilizes a mesh network
- Enhanced Flash and RAM memory for better performance
- Anodized aluminum casing
- Hard-wired with double-insulated wiring
- IP66 rated (dry, damp and wet locations)
- Overvoltage, overtemperature, short circuit and surge protection
- 5-year warranty

### SPECIFICATIONS

Driver Type	Constant Voltage	Housing Material	Extruded aluminum
Rated Input Voltage Range	100-277 VAC	Ambient Operating Temperature	-40 – 50 °C (-40 – 122 °F)
Input Frequency	47-63 Hz	Storage Temperature	-40 – 80 °C (-40 – 176 °F)
Input Current (Max.)	2.1 A @ 120 VAC, 1.1 A @ 230 VAC, 0.92 A @ 277 VAC	Max Relative Humidity	20-95% RH (NC)
PWM Frequency	Average 5.2 kHz	Overvoltage Protection	Yes
THD	< 15%	Short Circuit Protection	Yes
Power Factor @ Full Load	≥ 0.98	Overtemperature Protection	Yes
Output Power	200 W	Surge Protection	L-N 2 kV / LN-G 4 kV
Output Voltage	24 VDC	Lifetime (L70 reported)	50,000 hrs. (tc 90 °C Max., ta = 50 °C)
Output Current (Max.)	8.33 A total	Dimensions (L x W x H)	279 x 78 x 25.1 m (10.98 x 3.07 x 0.99 in.)
Efficiency @ Full Load	93%	Weight	1 kg (2.2 lb)
Dimming Control	Bluetooth / Casambi	Warranty	5 years
Ingress Protection	IP66		
Output Ripple (100 Hz)	≤ 1%		

### ORDERING GUIDE

Category	Voltage	Wattage	Compatibility
DRVW	24	200	CAS4CH
DRVW - Waterproof Driver	24 - 24 VDC Output	200 - 200 W	CAS4CH - Casambi Compatible 4 Channel

Acolyte does not warrant or represent that the information is free from errors or omission. The information may change without notice and Acolyte is not in any way liable for the accuracy of any information printed and stored or in any way interpreted or used.

**CASAMBI APP INSTALLATION INSTRUCTIONS**

1. Download the CASAMBI app and install it on your phone.



2. Open the Casambi app, then click "My networks." Click the circle in the top right with three dots inside and choose "Create a network."

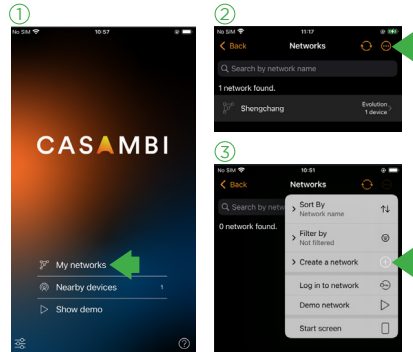

3. Click "Evolution." To create a name for your new network, click "Sharing." Select "Administrator only" or "Password protected" and input the new password. Select "User," "Manager" or "Admin." When finished, click "Done" at the top right of the screen.

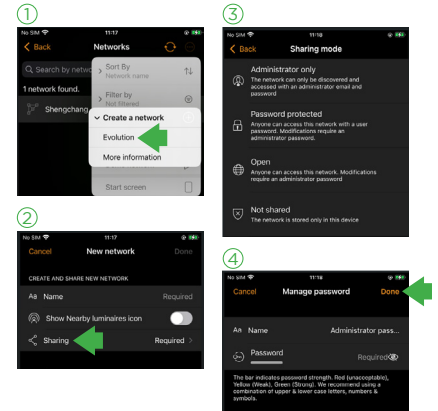

4. Click "My networks" to enter the app. (You will see your new network listed there. Example: "Lobby.")

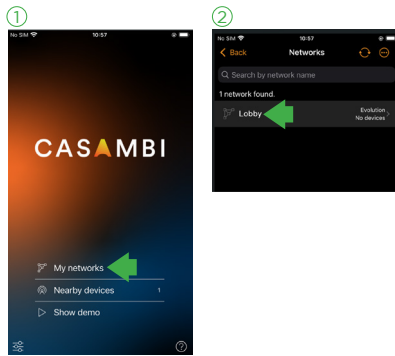

5. Go back to the main page and power on the Casambi driver. Log back into the Casambi app. You will see a '1' listed after "Nearby devices." (If you powered on two Casambi drivers, you will see a '2'.)

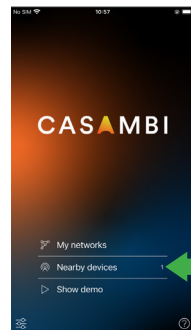

6. Click "Nearby devices." You will see a list of unpaired devices.

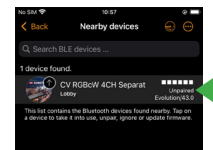

7. Click on the new device, then select "Add to ..." and select the new network to pair the device with the new network you created.

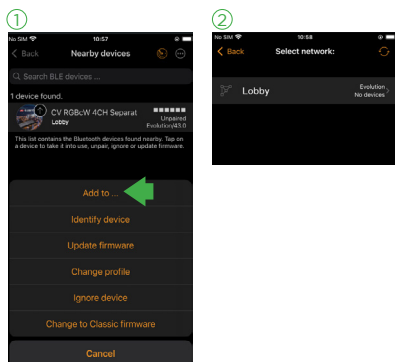

8. Double click the paired device, then go to the reference page to rename the paired device. Click "Model" to update the proper profile (RGBW 4CH Separate).

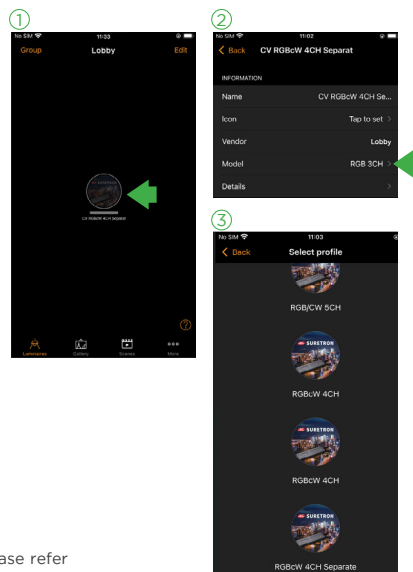

9. After selecting the profile, click "Start update." When the update is finished, you can click the device to switch the driver output on and off; you can double click the device to enter the device reference page; or you can select "Device" and hold it for a few seconds so that it takes you to the dimmer page. The four dimmer channels respectively represent Red, Green, Blue and White. They can be intuitively adjusted with the sliders or the plus/minus buttons.

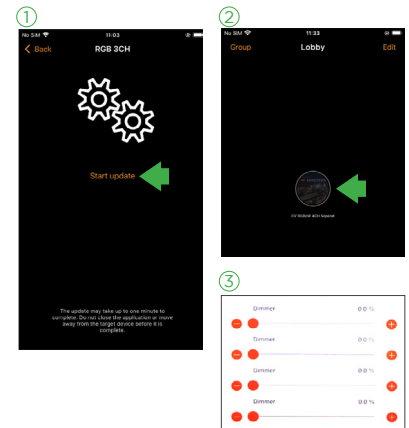

NOTE: For a complete system setup with multiple devices, please refer to the Casambi app user guide.

**DIMENSIONS**

**L x W x H**

279 x 78 x 25.1 mm

10.98 x 3.07 x 0.99 in.

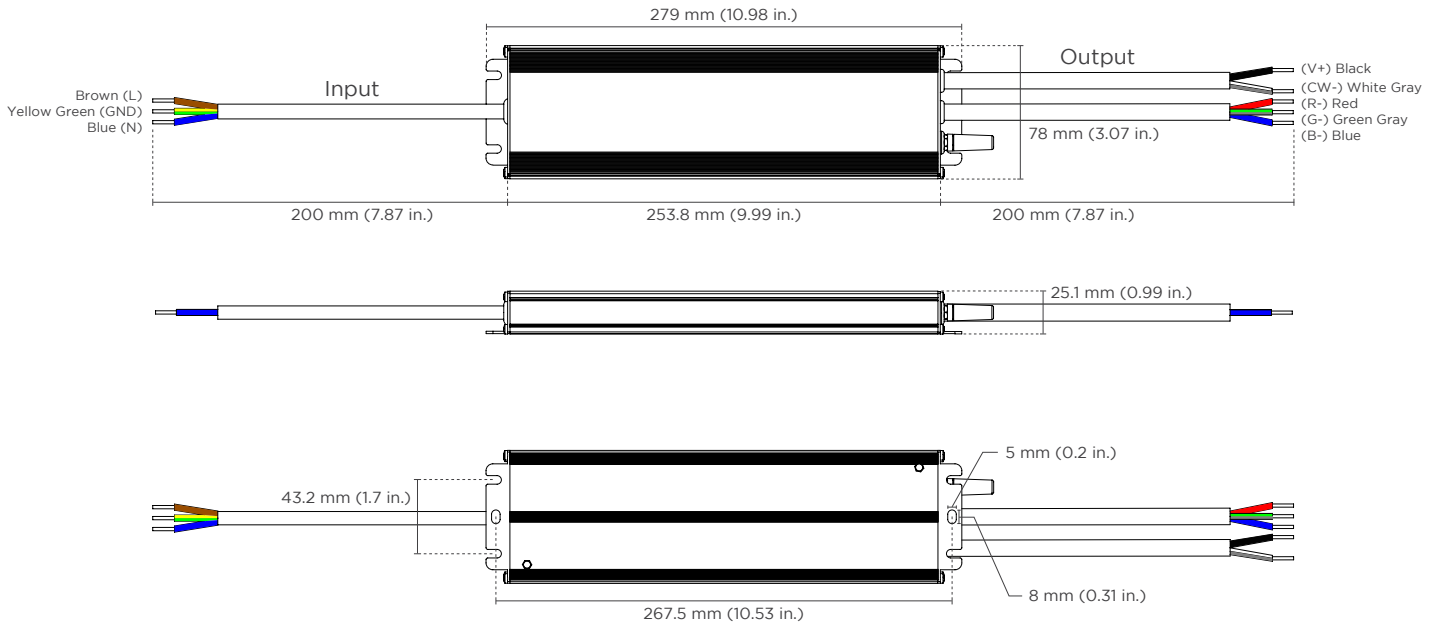

**NOTE:** To prevent exposure to the maximum allowable temperatures for these drivers, the suggested installation spacing between drivers is at least 4 in. (101.6 mm) side-to-side when the distance to the sidewall and top of the enclosure is 2 in. (50.8 mm). When the distance to the sidewall and top of the enclosure is 6 in. (152.4 mm), maintain at least 2 in. (50.8 mm) side-to-side spacing between drivers. Drivers should be placed at a minimum of 1 in. (25.4 mm) apart when arranging them end-to-end regardless of the enclosure size.

REV.19MAY2026

**GLOBAL HQ**

320 Murray Hill Pkwy  
East Rutherford, NJ 07073  
U.S.  
T: (+1) 212 629 6830  
E: Sales-US@GENLEDBrands.com

**EUROPEAN HQ**

Hogeweyselaan 119  
1382 JK Weesp  
Netherlands  
T: (+31) 346 235 000  
E: SalesEurope@GENLEDBrands.com

**MEINA HQ**

PO Box 371378, #823, Building 4EA  
Dubai Airport Free Zone  
Dubai, UAE  
T: (+971) 4 701 7901  
E: SalesMEINA@genlebrands.com

**ASIA-PACIFIC HQ**

Room 402, Building D  
ShenShi Tongchuang Science and Technology Park  
No. 16 Hongyin Road  
Xingqiang Community, Xihu Street  
Guangming District, Shenzhen, China 518107  
T: (+86) 755 8529 0710  
E: Sales-Pacific@GENLEDBrands.com